

# HILTI

Hilti  
Direct Fastening  
Brochure



**Hilti Direct Fastening – can reduce your labour time by up to 65%.**

**Hilti. Outperform. Outlast.**

# Welcome.

At Hilti, we are committed to working with you as partners in your field of expertise to help maximise your business. Hilti offers innovative and quality solutions to support you, along with various ways to contact us and make your life easier.

## Customer Services

- Available Monday to Friday 8.00am to 6.00pm
- Highly trained team of Customer Services Advisors
- Provide product advice, orders, delivery tracking

## Hilti Centres

- Opening hours Monday to Friday 8.00am to 5.00pm
- Demonstrations of machines and systems available
- Purchase or order tools and consumables instore

## Hilti Online

- Hilti website available 365 days per year 24/7
- Personalised self-service purchasing with tailored prices
- Standard next working day delivery is free-of-charge for all online orders

## Account Managers

- Professional advice available from Hilti in your local area
- Product and system demonstrations at your place of work or on-site
- Customer Services can put you in touch with the your local Hilti Account Manager

## Field Based Engineering

- Nationwide team of experienced and qualified engineers
- Comprehensive technical/engineering advice and design support
- Technical seminars, on-site testing and installation guidance



Telephone:

0800 886 100 (GB) 1850 287 387 (IRE)

Fax:

0800 886 200 (GB) 1800 654 600 (IRE)

Online:

[www.hilti.co.uk](http://www.hilti.co.uk) [www.hilti.ie](http://www.hilti.ie)

**Support Engineering**

- Central Engineering office staffed by experienced and highly trained engineers
- Advice and calculation assistance available
- Online comprehensive Technical Library

**Repair Centres**

- Arrange for repairs via Hilti Centres, Customer Services or online
- Pick-up and delivery available
- Aim to have Hilti tool back to you within 3-5 working days

**Outstanding service for a product lifetime.**

The unique service package for those who prefer to own their own tools.

Hilti tools are built to last. But even if a defect occurs, Hilti will take care of it. Quickly and professionally, completely free of charge for up to 2 years from date of purchase. After that we continue to prove the quality of our products by putting a limit on what a repair can cost – for as long as you continue using your Hilti tool. We even give you a lifetime manufacturer’s warranty against manufacturing defects. That’s not just reassuring to know, it’s unique in this field.

**We manage your tools.**

So you can manage your business.

With Hilti Fleet Management, a fixed monthly charge covers all tool, service and repair costs. That greatly simplifies your financial planning and takes a load of administrative work off your shoulders. There are no hidden costs. All tools in the fleet are replaced at regular intervals with tools of the latest generation, thus helping to avoid costly downtime and ensuring compliance with the latest safety standards.



<b>HILTI</b>	up to <b>2</b> Years
<b>LIFETIME SERVICE</b>	<b>NO COSTS</b>
Lifetime	Lifetime
<b>REPAIR COST LIMIT</b>	<b>MANUFACTURER'S WARRANTY</b>

**HILTI**

**FLEET MANAGEMENT**

# Productivity.

Hilti Direct fastening is an innovative system that will make a large number of fixings quickly and safely with no need for power supplies or skilled labour.

- Can make in excess of 1000 fixings per day
- Fix into a wide range of base materials including steel and concrete
- Integrates with Hilti positioning systems to save marking out time
- Specialist fasteners available to suit different trades

Controlled tests carried out by BSRIA who describe themselves as performing “**Independent Certification and performance verification**” show that in a comparison with the traditional methods when fitting 200mm circular ductwork over a 6 metre length and a fan coil unit the total installed cost was 36% lower.

The same trial also showed that the labour content of the operation was reduced by 65%.

The test was carried out on an active construction site and involved a project team of construction professionals.

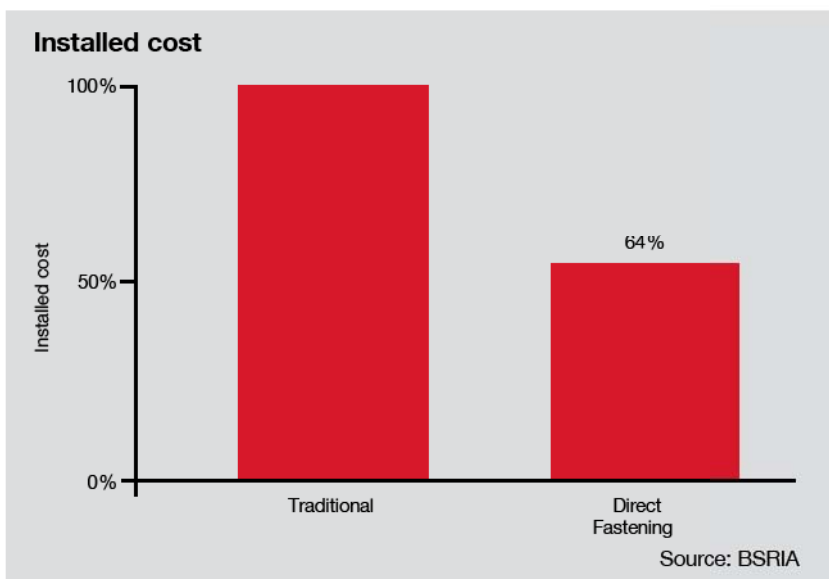

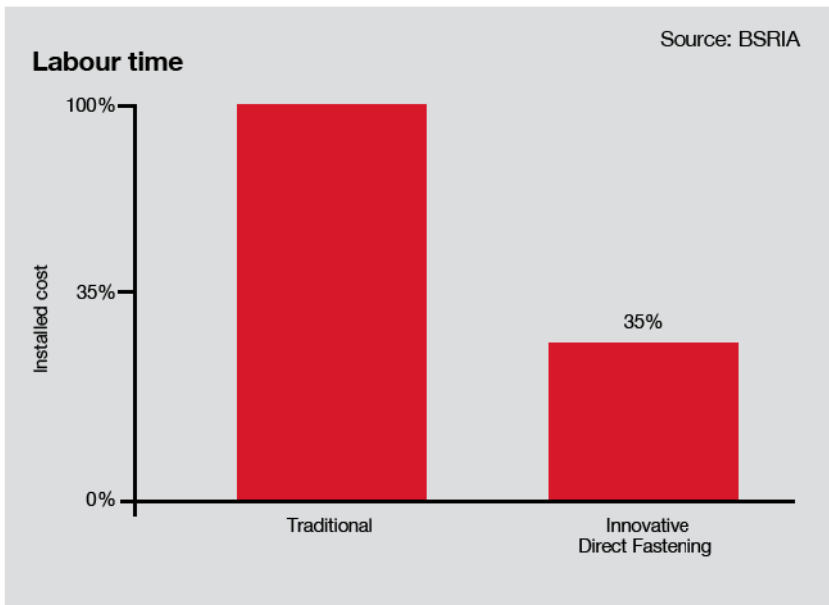

## The Hilti Difference 65% savings

Hilti Direct fastening (DX) is the ultimate cordless fastening system designed with productivity in mind. DX fastening methods can reduce labour time by as much as 65% and installation costs by 36%.

### Contents

Welcome	2-3
Productivity	4-5
What is Direct Fastening?	6-7
Benefits of Direct Fastening	8-9
Health and Safety	10-11
System Safety	12-13
Fastening Safety	14-15
Fastening to Steel	16-17
Fastening to Concrete	18-21
Fire Data	22-23
Cartridges	24-25
Application Examples 1 - 5	26-34
Training	35-36
Risk Assessment Guidance - DX	37
Lifetime Service for DX	38-39
Approvals	40-41
Load data	42
Quick Reference Guide	43

# What is Direct Fastening?

**By direct fastening we mean using a powder charge to “drive” a fixing which can be a nail, stud or specialised fastener into a solid base material.**

Fixings can be made directly into the base material or in other cases through another material in order to fix it onto the base material. Base material can be steel, concrete or masonry.

DX is the name given to Hilti direct fastening products.

## Direct Fastening for more than 50 years

Powder Actuated fastening was pioneered by Martin Hilti during the 1940's and the DX range as it has become known was one of the earliest products in Hilti's independent product line. Developed from an early basic design, Martin Hilti was so enthusiastic about the tool's ability to drive nails into a variety of these materials including concrete and steel, that he bought the original design and patent rights. Martin Hilti's company as innovative then as they are today, set to work improving and refining the design and its safety. Introduced to the market in 1952 with further refinements in 1953 these earlier models were sold under the brand name Perfix until 1954 when the Hilti name was adopted for its growing and improving product lines.

Innovation followed innovation through the early fifties leading to the introduction of the DX100 in 1957, more than fifty years ago.

The DX 100, led Hilti's expansion into the international market throughout Europe and into the Americas, ultimately leading to the formation of the Hilti corporation in 1960.

The story of the inception, development and continuing innovation of that original machine to the DX machines that we know today illustrates the philosophy that drives Hilti and its commitment to provide the best tools for the job.

## Still in use today!

Hilti regularly receives calls from customers still using their original tools which in some cases could be up to 50 years old! We are happy to supply parts and consumables for these tools where they are still available.



**DX 460 and X-FS formstop.**

## Fastening System

Direct fastening systems are developed and tested as a complete System. The tool, magazine, fastener programme and cartridge programme form a “technical unit”. This means that optimal fastening with this system can only be assured if the fasteners and cartridges specially manufactured for it, or products of equivalent quality, are used. The fastening and application recommendations given by Hilti are only applicable if these conditions are observed. Selecting the correct combination of these elements is essential to ensure that high quality fastenings are achieved quickly, safely and reliably.

## System Selection

The system selection starts with the application, an example of correct system selection is shown below.

### Example: Fixing wood to concrete to hold formwork in place

- Base material: New concrete, < 6 months old (strength < 35N/mm<sup>2</sup>)
- Material to be fastened: Wood - 25mm thick
- Load required: < 0.4 kN Shear and Tension
- Environment: Short term exposure to weather (i.e. during construction)

As time period is short, stainless steel is not required in this case. Concrete base material – embedment required 27+/-5mm. Material thickness to be fastened – 25mm

- Fastener length – 52mm

Load required < 0.4 kN/fastening Shear and Tension

- Possible fastener choices (not complete list) are:

- X-DNI P8/S12... (is pull-over a concern?)      • X-SL-DP8... (is fast removal required?)
- X-DNI-MX... (are repetitive fastenings required?)      • X-SL-MX... (repetitive installation and fast removal)

Chose **X-SL-MX 54mm**

**DX 460-P8 tool**

### Magazine nails required to use

- MX 72 Fastener Guide

**X-460-P8 standard piston**

**Cartridge selection. To be checked on site**

### Step 1 - What is the Application?



### Step 2 - What fastener do I require?



### Step 3 - Tool



### Step 4 - Fastener Guide



### Step 5 - Piston



### Step 6 - Cartridge / Power Setting



# Benefits of Direct Fastening.

## Productivity

The ability to make direct fixings without the need to drill any holes is simple, fast, safe and highly productive. The Hilti DX fastening system can be learned quickly by operatives, to offer a versatile fastening technique. Even in the hardest and thickest based materials Direct Fastening can be used but in these cases pilot holes may be required. Ask about our X-BT (steel) and DX Kwik (concrete) solutions.

DX fastening tools are completely self contained requiring only the necessary consumables (fastener and cartridge) for the tool and the job it is therefore, the **ultimate cordless fastening system**.

The result is that fixings are made quickly and efficiently, reducing - project time, labour content and instigating overall cost savings.

- No skilled labour required
- Higher productivity
- Lower installation costs

## Forward Planning

### Specification

The benefits of direct fastenings can be maximised if installation drawings are produced that wherever possible use common levels, which simplify the process of setting-out. This will enable the effective use of modern laser setting-out devices, which can operate in conjunction with powder-actuated fastening tools to provide a quick method of locating fixing points.

Full technical information is available via Hilti Technical Services on:

GB 0161 886 1144 or go online:

[www.hilti.co.uk](http://www.hilti.co.uk)

IRE 1850 287 387 or go online:

[www.hilti.ie](http://www.hilti.ie)

Total installed cost comparison:  
100 fixings

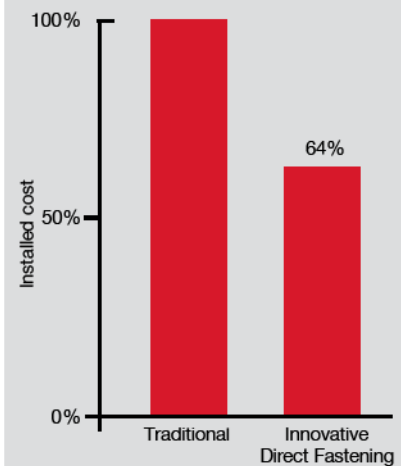

Hilti PR15  
setting-out laser.



The illustrations below show some of the main reasons why contractors are interested to use powder or gas-actuated fastening.



1. Speed is important.

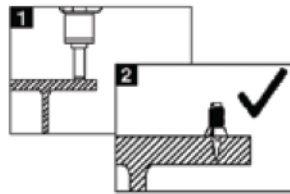

2. An easy-to-use, uncomplicated fastening system is required.



3. A weather-independent fastening system is required.



4. Electric power is not available or electric cables would hinder the work.

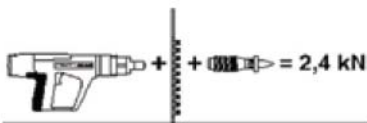

5. A complete fastening system with assured strength is required.

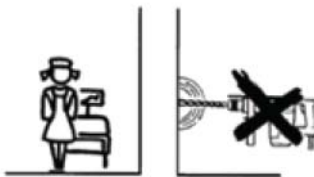

6. Drilling is not viable because of noise.



7. Drilling would be too difficult.



8. Drilling would cause too much dust.

# Health and Safety.

## Construction Health and Safety

In all cases, employers and self-employed people are responsible for assessing the risks that may be involved in the work they are planning to carry out.

For example, here are some key requirements from the “Vibration Directive”

- Assess the risk to the Health of the employees and plan for its control
- Provide suitable equipment for their employees to use
- Give their employees information and training on health risks and safe use of equipment

### How can Direct Fastening help?

Where there are concerns about the possible effects of Hand Arm Vibration (HAV) due to drilling using “electric hammer drills or combihammers”. Direct Fastening is recognised as an Alternative Method to reduce this risk.

(Source – HSE Website)

<http://www.hse.gov.uk/vibration/hav/campaign/construction.htm>

More guidance on risk assessment is available from the HSE e.g.

1. A Guide to Risk Assessment Requirements (HSE INDG218)
2. HSE Five Steps to Risk Assessment (HSE INDG163)

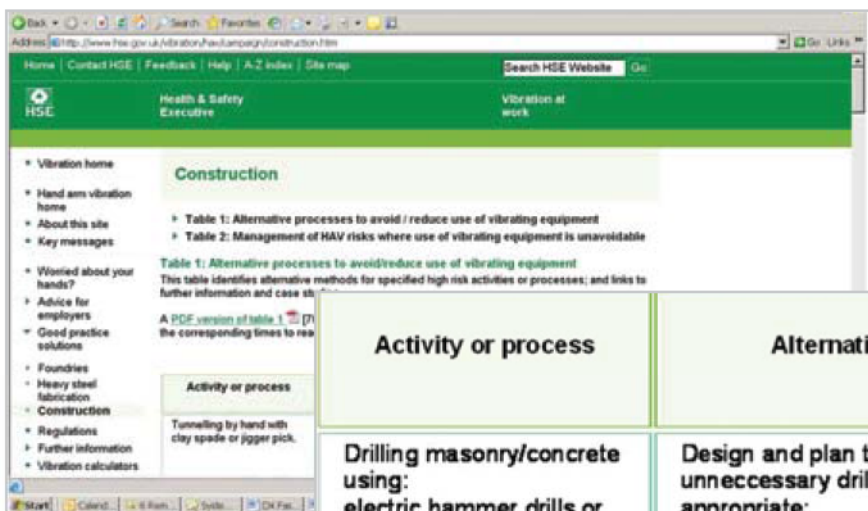

Activity or process	Alternative methods	Further information (links)
Drilling masonry/concrete using: electric hammer drills or "combihammers"	Design and plan to avoid unnecessary drilling. Use, where appropriate: <ul style="list-style-type: none"> <li>• jig-mounted drilling</li> <li>• diamond core drilling (clamped in rig)</li> <li>• cast-in anchors and channels for wall fixings instead of drill-and-fix types</li> <li>• use of direct fastening tools</li> </ul>	

Example:

**Permitted number of fastenings per day**  
using Hilti Direct fastening technology.

Tool Type	Permitted number of fastening/day	
	Action Value A(8) 2.5 m/s <sup>2</sup>	Limit Value A(8) 5 m/s <sup>2</sup>
GX 120	3,500	14,000
DX 460 (red cartridge)	1,000	4,000

See the Hilti Product Selector for more details. [www.hilti.co.uk/productselector](http://www.hilti.co.uk/productselector)

The recoil values itemised in this table are generated from laboratory tests and are not a guarantee of actual recoil values on any specific application at the site.

Therefore, these recoil values are an aid only. The employer is responsible for adhering to the legal requirements for workplace health and safety and for the evaluation of the actual recoil values by respective on-site measurements

- Values are average values and are rounded
- Underlying measurements are one-dimensional and are performed as typical applications under laboratory conditions according to ISO 8662-11.

### Other Safety Benefits

- **Cordless:** DX tools are completely cordless in operation, leaving no trailing power leads to cause trip hazards or problems for the operator.
- **Weather:** DX tools can be used whatever the weather.
- **Ergonomics:** “Stand Up” tools and “Pole Tool” attachments are available to increase working comfort.



**Trailing Cables.**



**DX 860.**

# System Safety.

In ANSI (American National Standards Institute) A10.3-2006, two types of tools are recognized: direct acting and indirect acting. The two types are defined by the manner in which the energy is transferred from the hot expanding gases to the fastener.

## Direct-acting tool:

The expanding gases act directly on the fastener and accelerate it to a velocity of 400 to 500 m/s

## Indirect-acting tool:

The expanding gases act on a captive piston that drives the fastener, which in Hilti indirect-acting tools obtains a velocity of less than 100 m/s

ANSI A10.3-2006 classifies powder-actuated tools according to velocity.

Class of powder-actuated tool	Average test velocity in m/s (FPS)	Maximum single test velocity m/s (FPS)
Low velocity	< 100 (328)	< 108 (354)
Medium velocity	< 150 (492)	< 160 (525)
High velocity	> 150 (492)	> 160 (525)

**All Hilti tools supplied for construction applications are low-velocity, indirect-acting tools.**

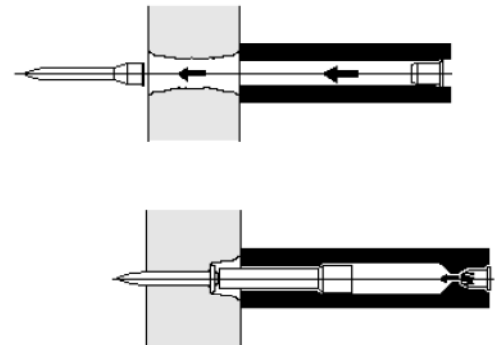

The DX tools are safety based items with features to ensure they are safe in operation for both the operator and those around them. Each tool features a five way safety system.

1. The Hilti Piston Principal, this means that the piston is “fired” onto the fixing pushing it into the base material. There is no direct contact between the charge and the fixing. At all times 90% of the energy is retained in the piston.
2. Drop firing safety device prevents the tool being fired accidentally if dropped or mishandled. (All DX tools meet statutory regulation requirements to be tested to 3 metres).
3. Contact pressure safety device, means that the tool requires a force of at least 50 Newton’s pressure against the base material before the tool can be fired
4. Trigger safety device to prevent accidental activation. Until the contact pressure has been taken off the trigger mechanism cannot be activated.
5. Unintentional firing mechanism. Unless the correct firing sequence is observed the tool cannot be fired.

**Other Safety Benefits.**

In addition to the DX tool being safe, the innate safety features of the system add to its operating safety.

Further safety benefits are:

- **Dust:** Operation of the tool is virtually dust-free, reducing dust which can be inhaled, in particular from overhead applications.
- **Noise:** Because they produce a low structural noise in concrete, it is possible that work can be carried out in inhabited buildings.
- **Working at Height:** If working overhead pole tool accessories are available which enable operation from floor level, likewise the tool has variants for work at floor level which removes the need for bending or kneeling when making multiple fixings.



# Fastening Safety.

## The necessary conditions for predictable fastening performance are:

1. The fastening system must have been engineered and tested for the application.
2. The quality of the fastening system components used must correspond to the quality of those originally tested.
3. The fastenings must be made as foreseen in the engineering of the system or in the same way as when the system was tested.

### Engineering and testing

Sources of information about the engineering and testing of a fastening system are the manufacturer's technical literature, test reports, official approvals, and publications in technical journals. If an "or equal" clause is used in the specification, then approval of any alternate fastening system should be made contingent on provision of documentation showing that the proposed fastening system has been engineered and tested for the application.

### Production quality

The need for the materials used on the jobsite to correspond to the design of the product and be of the same quality as those tested is clear. This requires the manufacturer to have a production quality control system, which is necessary for ISO 9001 certification.

In addition to ISO 9001 (Quality Management) Hilti also have 14001 (Environmental Management).

### Manufacturing Process – Standard Hardened Steel Fasteners

Almost all powder and gas-actuated fasteners used in the world are manufactured from carbon steel wire and are thermally hardened to obtain the strength needed for driving into steel and concrete. Zinc plated fasteners are subjected to impact bending tests to check the effectiveness of the process. Depending on their intended application, some fasteners are additionally sampled and tested in tension and shear.

### Stainless Steel Fasteners

In 1994, Hilti introduced the first powder-actuated stainless steel fastener. These fasteners are manufactured from special stainless steel wire with an ultimate tensile strength of 1850 MPa and are not thermally hardened. These fasteners suffer only a minor decrease in strength when subjected to high temperatures as in a fire and give much improved corrosion resistance.

### Manufacturing Process Standard Zinc Coated Fasteners

Cut to length and form head

(Knurling)

Forge points

Thermal hardening

Galvanising

Baking

Assembly with washers



**Quality of installation**

The use of fastening systems for which the manufacturer provides application guidelines and a technical advisory service helps ensure that fasteners will be installed correctly and enhances proper fastenings.

The concept of controlling the quality of the work must include some feature that can be measured and that feature must indicate the performance of the fastenings.

**Corrosion**

The subject of corrosion has a major influence on the suitability of a fastener and therefore also on fastener selection.

**Non-safety relevant applications**, zinc plated fasteners made of normal carbon steel can be used without restriction.

**Safety relevant, permanent** fastenings the following table shows the suitability  under different atmospheric conditions.

Condition for use	Fastener	
	Zinc plated carbon steel	X-CR / X-BT stainless steel
Inside rooms without condensation and corrosive gases	<input checked="" type="checkbox"/>	<input checked="" type="checkbox"/>
Inside with heavy condensation	<input type="checkbox"/>	<input checked="" type="checkbox"/>
Short term exposure to weather (i.e. during construction)	<input checked="" type="checkbox"/>	<input checked="" type="checkbox"/>
Outside, coastal area or industrial atmosphere without chloride	<input type="checkbox"/>	<input checked="" type="checkbox"/>
Highly corrosive surroundings (indoor swimming pools, highway tunnels)	<input type="checkbox"/>	<input type="checkbox"/>

**For safety relevant, permanent fastenings:**

Use HILTI galvanized DX- fasteners only for dry indoor applications. In higher corrosive and/ or wet atmospheres the usage of HILTI X-CR fasteners is recommended.



Checking the standoff of an X-EDNK22 roof deck fastening with a plastic template.



Pullout test of an ENP fastening with a Mark V tester and ENP adapter.

Fastened part / base material	Fastener	
	Zinc plated carbon steel	X-CR / X-BT stainless steel
Construction steel (uncoated)	<input checked="" type="checkbox"/>	<input checked="" type="checkbox"/>
Galvanised steel sheet	<input checked="" type="checkbox"/>	<input checked="" type="checkbox"/>
Aluminium alloy	<input type="checkbox"/>	<input checked="" type="checkbox"/>
Stainless steel sheet	<input type="checkbox"/>	<input checked="" type="checkbox"/>

Heavy corrosion of fastener  
 Negligible or no corrosion of fastener

# Fastening to Steel.

## Anchoring Mechanisms

The following four mechanisms cause a DX- / GX-fastener to hold in steel base material.

- clamping
- keying
- fusing (welding)
- soldering

These mechanisms have been identified and studied by analyzing pullout test data and by microscopic examination of fastening cross-sections.

## Clamping

As a fastener is driven, the steel is displaced radially and towards both the entry and opposite surfaces. This results in residual pressure on the surface of the nail, which leads to friction or clamping.

## Keying

The keying mechanism is possible when the fastener is knurled, that is, it has grooves along the shank in which zinc and particles of base steel accumulate during the driving process. Keying is an especially important anchoring mechanism for fasteners that do not penetrate right through the base material.

## Fusing (welding)

Complete fusing of the fastener with the base steel is indicated by portions of base material clinging to the extracted fastener. Fusing or welding is observed mostly at the point of a fastener where the temperature during driving can be expected to be the highest.

For fasteners that do not through-penetrate, this is an important anchoring mechanism.

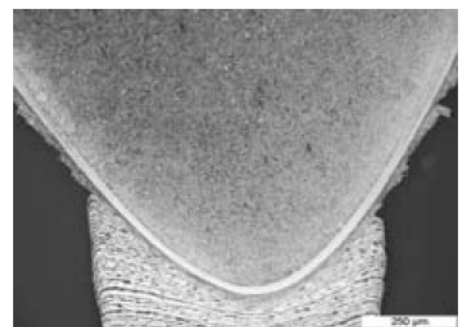
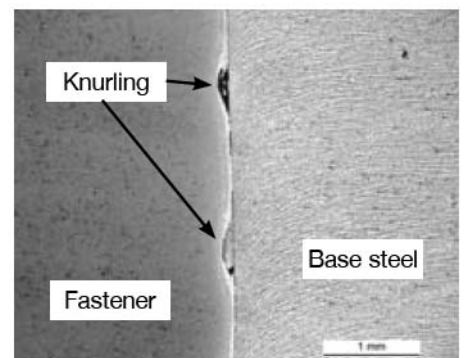
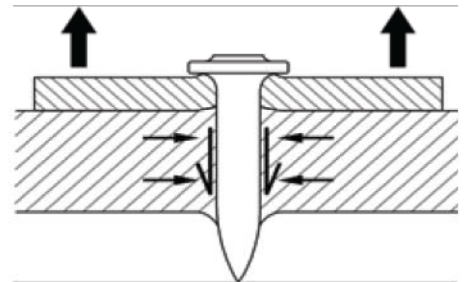
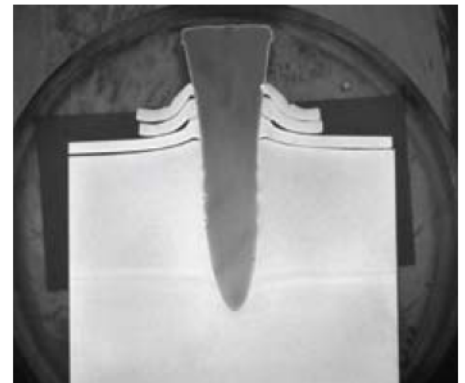



**Fusing (Soldering)**

In the zone further from the point, there is a prominent zinc layer separating the fastener from the base steel. This zinc, soldered to the base steel, also makes a contribution to the pullout resistance of the fastener.

**Cyclic Loading**

Siding and decking nails used in wall and roof construction are subject to cyclic loading from wind suction. Cyclic load testing is carried out to determine characteristic resistance and allowable (recommended) loads. The approval requirements of the European Technical Approval ETA prepared by DIBt (Deutsches Institut für Bautechnik) govern the design relevant number of load repetitions (5'000) and the necessary safety factors. Notes in this regard can be found on the corresponding product data sheets, e.g. X-ENP-19 L15..

**Mode of Failure under Cyclic Loading**

A major finding of cyclic loading tests is that the strength of a DX fastening subject to cyclic loading is not limited by failure of the anchorage.

**Effect of fasteners on structural steel**

Driving powder- or gas-actuated fasteners into a steel member does not remove steel from the cross-section, but rather displaces steel within the cross-section. It is therefore not surprising that tests show that both drilled holes and screws, either self drilling or self tapping, reduce the strength of a cross-section more than a powder-actuated drive pin.

**Typical Application Guidelines – Steel**

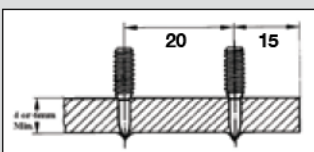

**Smooth or Knurled Shank Nails**

**Correct fastener length**

**Knurled Shank** = 10-14 mm base material penetration + thickness of material to be fastened

**Smooth Shank** = 17-27 mm base material penetration + thickness of material to be fastened

**Minimum steel thickness**

Fastener with shank diameter of **3.7 mm** = **4 mm**

Fastener with shank diameter of **4.5 mm** = **6 mm**

Edge Distance = **15 mm**

Spacing = **20 mm**

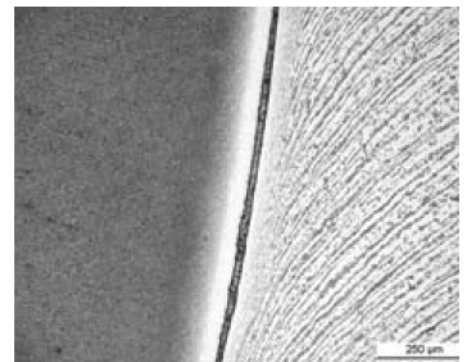

X-ENP-19 L15 ETA-04/0101.

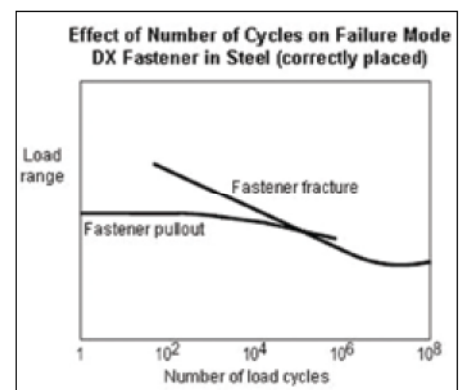

# Fastening to Concrete.

## Anchoring Mechanisms

The following three mechanisms cause a DX-/ GX-fastener to hold in concrete base material:

- Bonding / sintering
- Keying
- Clamping

These mechanisms have been identified and studied by analysing pullout test data and by microscopic examination of pulled-out fasteners and the concrete-fastener interface.

## Bonding / sintering

When driving a fastener into concrete, the concrete is compacted. The intense heat generated during driving causes concrete to be sintered onto the fastener. The strength of this sintered bond is actually greater than that of the clamping due to reactive forces of the concrete on the fastener.

## Keying

The sintered material forms ridges on the fastener surface. These ridges result in a micro-interlocking of the fastener and the concrete.

## Clamping

The compressibility of concrete limits the buildup of compressive stress around the driven fastener. This in turn limits the effectiveness of clamping as an anchoring mechanism.

## Concrete failure

Occasionally concrete cone failure is observed when using a testing device with widely spaced supports. The fact that the concrete failed indicates that the fastener bond to the concrete was stronger than the concrete.

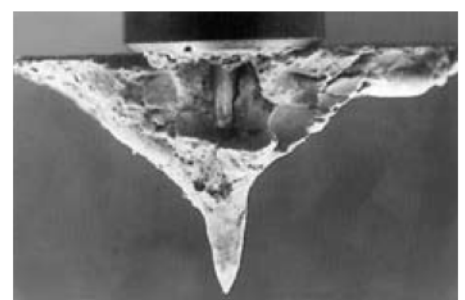
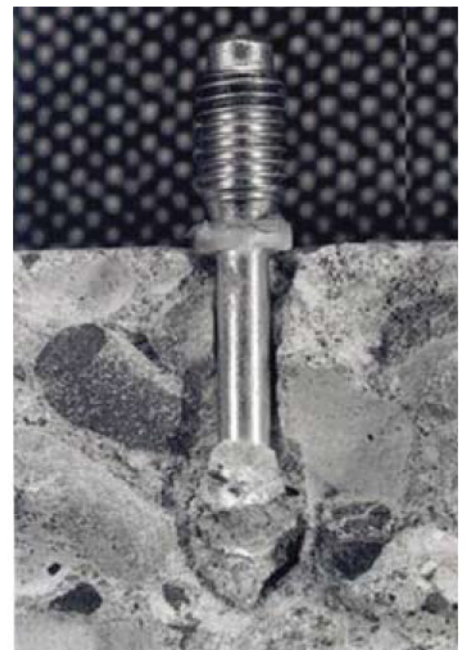

**Factors Influencing the Resistance to Pullout**

Factors that can affect the pullout strength of fastenings to concrete include:

- depth of penetration into the concrete
- concrete conditions (compressive strength, grain structure, direction of concrete placement)
- distance to concrete edge and fastener spacing

**Depth of penetration  $h_{ET}$**

Fasteners that are driven deeper typically have a higher resistance to pullout. This relation is best shown by placing groups of fasteners with different driving energy and comparing the results for each group with the others.

The result of such a test is shown in the graph at the right. Note that placing failures were not considered in calculation of the average ultimate load,  $N_{u,m}$

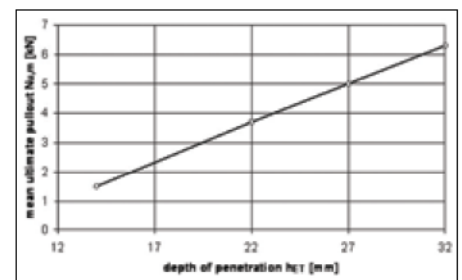

**Note:** the technical data for the fixing gives load capacities for different embedment depths.

**Concrete Conditions**

Pullout strength and placing failure rate both increase with increasing penetration depth. The optimum depth of penetration is taken as the depth at which the yield in terms of pullout strength begins decreasing. It's within a range of 18 – 32 mm depending on the grade and age of the concrete as well as the strength of the fastener.

Type and size of concrete aggregates, type of cement and the location on top or bottom side of a concrete floor do affect the placing failure rate, sometimes significantly

Placing failures are caused by the fastener hitting a hard aggregate like granite located close to the concrete surface. In case of slight fastener bending, there may be concrete spalling at the surface. However, because pullout strength is obtained mostly in the area of the fastener point, concrete spalling does not affect the allowable load of the DX- / GX-fastening.

Overhead fastening is usually associated with more placing failures than floor fastening. This is due to the direction of concrete placement. Large aggregates tend to accumulate at the bottom of a floor slab. At the top, small aggregates and fines will be in the majority.

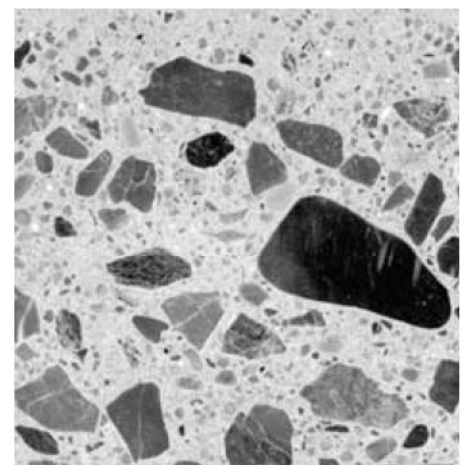

**Note:** placing failures are accounted for within the limits of the technical data for the fixing. These placing failures are the reason multi-point fixings are required in concrete.

# Fastening to Concrete etc.

Several possibilities exist to reduce the failure rate when powder actuated fasteners are used for fastening to concrete. There are two basic ideas. One is to reduce concrete tensile stresses near the surface. The other is to delay the effect of these stresses.

- **Pre-drilling the concrete (DX-Kwik)**

By pre-drilling a very small hole, 5 mm diameter by 18 or 23 mm deep, the stresses are relocated to deeper in the concrete. Fasteners placed with DX-Kwik are surrounded by a stress bulb that is deep in the concrete. With this method no placing failures will occur. DX Kwik fixings have a higher load capacity than standard DX fixings and can be used for single point fastening.

- **Spall stop fastener guide**

A spall stop is a massive steel fastener guide. Its weight and inertia counteract the stresses at the surface for a very short time. This allows a redistribution of the stresses to elsewhere in the concrete.

Changing from a long to a short fastener reduces the magnitude of the stresses and hence placing failures but gives a lower load capacity for successful fixings

### Edge distance and fastener spacing

If fasteners are placed too close to the concrete edge, the pullout capacity will be reduced.

The typical edge distance in case of reinforced concrete is 80 mm and in case of non-reinforced concrete, 150 mm. Edge distances and spacing guidelines have the purpose of helping to prevent concrete spalling and/or cracking due to fastening. However, in general, spalling has only an insignificant influence on the pullout strength.

### Typical Application Guidelines – Concrete

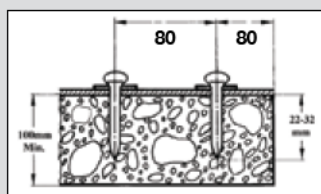

#### Smooth Shank Fasteners Only

#### Correct fastener length

22-32 mm base material penetration  
+ thickness of material to be fastened

e.g. 35 mm thick timber would require a nail between 57 mm and 67 mm long.

In this case, a 62 mm nail would be most appropriate.

Edge Distance = **80 mm**

Spacing = **80 mm**

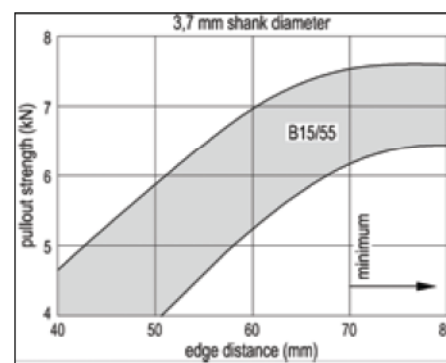
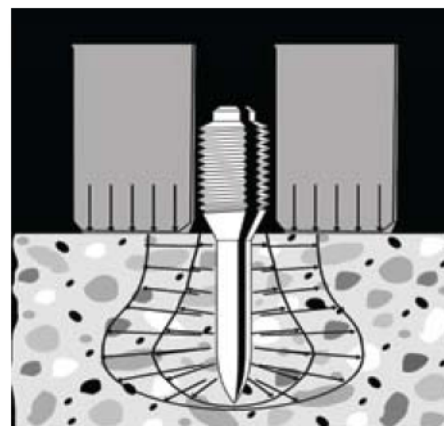
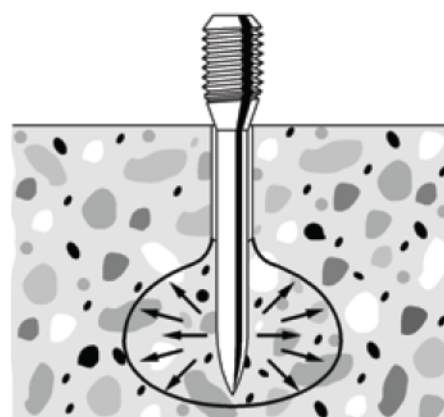

**Effect of time on pullout resistance**

The effect of age on pullout strength was investigated in a comprehensive test. The test results indicate very strongly that relaxation of the concrete has no detrimental effect on the pullout resistance of DX fastenings.

**Effect on concrete components**

Fastenings in the compressive zone of the structure have no effect on concrete compressive resistance as long as detailing provisions on edge distance and spacing are fulfilled.

For fastenings in the tensile zone the following provisions are provided:

**Installations into plane load bearing components like concrete walls or ceilings are generally possible without restrictions.**

**a. Fastenings in reinforced concrete beams:**

It has to be ensured that the main reinforcement steel will not be hit or penetrated by the DX fasteners. This measure of precaution is mainly founded on the reduction of the ultimate strain of the reinforcement steel.

Exceptions are possible when consulting the structural engineering responsible for design.

**b. 1. Fastenings in pre-stressed concrete members:**

It has to be ensured that the pre-stressing reinforcement steel or cables will not be hit or penetrated by the DX fasteners.

**b. 2. Hilti have recently completed a series of tests on Precast concrete slabs.**

Details of the fastening recommendations are provided in the associated Data Sheet available on request from Hilti Technical Advisory Service: +44 161 886 1144.

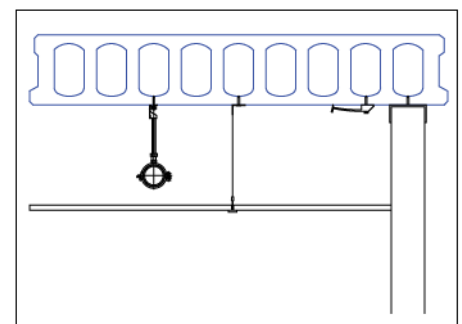
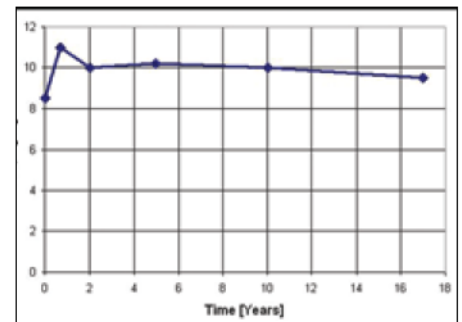

# Fire Data.

When subjected to high temperatures as in fire, the properties of both the fixing and the surrounding base material are degraded. In order to provide designers with appropriate information for fixings which are to be used in situations where they cannot be protected from the possibility of fire, Hilti have fire tested loaded fixings inside a furnace which was heated in accordance with the ISO 834 heating curve.

### Fire rating on fastening to concrete

This data applies only to fastenings made in reinforced concrete components of a grade C20/25, which has at least the same duration of resistance to fire. Data is valid for standard sizes.



Fire Resistance

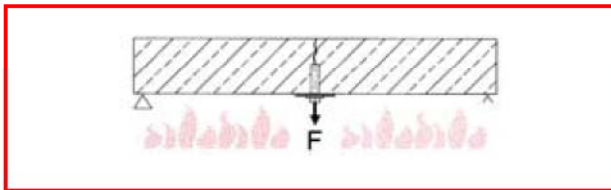

Tested in cracked concrete directly exposed to flames without taking any insulating or protective measures.

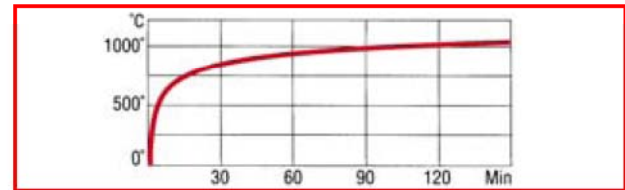

Tested according to the internationally standardised temperature curve (ISO 834).

Anchor, Fastener	Size	Maximum load (kN) for specified duration of resistance to fire (min)				IBMB test report no. / Technical University of Brunswick, Germany
		30 min	60 min	90 min	120 min	
 DX-Kwik *)	X-M6H				0.20	3882 / 5651+E
	X-M8H			0.30		
	X-CR-M8			0.30		
 *)	X-CR 48		0.45	0.25		
	X-HS-M6	0.40	0.25	0.15	0.05	3027 / 0274-3+E
 *)	X-HS-M8	0.50	0.40	0.25	0.15	3027 / 0274-7
	X-HS-M10	0.50	0.40	0.25	0.15	

\*) application in ceiling and wall.

## Fire Rating on Fastenings to Steel

### Standard zinc plated, thermally hardened steel fasteners

When subjected to high temperatures as in a fire, both powder-actuated fasteners and structural steel lose strength.

Up to about 300°C, the strength loss for DX fasteners is roughly proportional to the yield strength loss of structural steel. At 600°C, DX fasteners have about 12% of their 20°C strength left and structural steel about 26%. Since DX fasteners obtain their high strength through thermal hardening process, the loss in strength at elevated temperatures is proportionally greater than for structural steel.

### Stainless Steel Fasteners (X-CR / X-CRM fasteners)

In 1994, Hilti introduced the first powder-actuated stainless steel fastener. These fasteners are manufactured from special stainless steel wire with an ultimate tensile strength of 1850 M/mm<sup>2</sup> and are not thermally hardened. These fasteners suffer only a minor decrease in strength when subjected to high temperatures as in a fire.

At 600°C, the X-CR / X-CRM material has 64% of its 20°C shear strength left. By comparison, standard fasteners have only 12% and structural steel only about 26%. The excellent fire resistance of the X-CR / X-CRM material alone justifies its use for some applications.

# Cartridges.

With savings of up to 65% labour time using Cartridge Tool technology, the new Clean-Tec cartridge strip with its innovative number scale on the back will help you achieve:

- Greater fastening efficiency making it even easier to use all 10 cartridges on the magazine strip
- Reduced Hazardous Waste costs as a fully used strip can be disposed of with “normal” site waste.
- Environment friendly as they contain NO lead or other “heavy metals”.
- Reduced tool cleaning by up to 30%

## Calibre and dimensions

The corresponding calibre is clearly printed on each cartridge package.

The following calibres are available from Hilti:

6.8/11 (cal. .27 short) in strips of 10

6.8/18 (cal. .27 long) as single cartridges or in strips of 10 or 40

The first number indicates the cartridge diameter and the second number indicates the total length of the cartridge, e.g. 6.8/11 M10 green

- Calibre: 6.8 mm
- Cartridge length: 11 mm
- Magazine strips of 10 cartridges: M10
- Power level: green

## Performance data

The driving power of the cartridge is determined to a very great extent by the quantity and properties of the propellant it contains. Cartridge power level classifications are laid down in the applicable regulations (e.g. PATMI) and are indicated by the corresponding colour code of the lacquer applied at the crimped tip of the cartridge or, respectively, by the colour of the magazine strip (see table). The colour is also marked on the package.

## Magazine strips

The cartridges are available singly or collated in magazine strips of 10 (=M10) or 40 (=M40). The strip material is a colored plastic that indicates the power level classification. Depending on the cartridge calibre and power level, the magazine strips may feature so-called safety locks to prevent insertion and use of the strip in tools for which they are not intended.

## Cartridge positioning index

An index scale (adhesive foil) on the rear of the magazine strip indicates which cartridge is currently in the cartridge chamber in the tool. This is helpful when partly-used strips are re-inserted in the tool for further use and also indicates

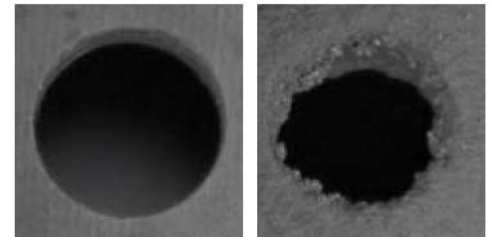

With Clean-Tec

Without Clean-Tec

Clean-Tec means less dirt and residues in the tool, less cleaning required and longer tool lifetime.

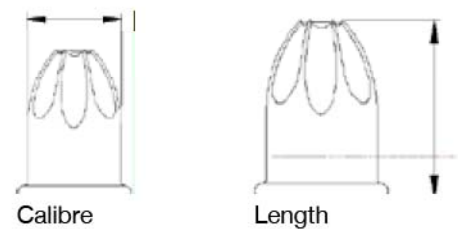

Calibre

Length

Colour	Power level
White / Brown	Extra light
Green	Light
Yellow	Light-medium
Blue	Medium
Red	Heavy
Black	Extra heavy

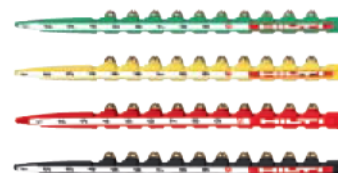



to the user in good time when the strip needs to be changed. This makes it easier to ensure that all cartridges on the strip can be used up, allowing the user to work more economically and making it possible to dispose of fully-used cartridge strips as normal site waste. Partly-used strips (containing one or more unspent cartridges) must be disposed of separately as “dangerous waste” in accordance with national regulations. More specific instructions can be found on the package (EWC no. 160401) and in section 2 of the safety data sheet.

**Approvals**

Hilti quality requirements correspond at least to the requirements of the DIN 7260 and ANSI A10.3-1995 standards.

In addition to individual national regulations, there is also the C.I.P. (Commission Internationale Permanente pour l'épreuve des armes a feu portative) – an international committee with the aim of ensuring high safety standards for users with regard to system performance and behavior (powder-actuated tool and corresponding cartridge). The appropriate requirements thus have to be met or tests repeated and passed at regular intervals or when modifications are made that affect the system as a whole. Independent testing agencies have been authorised by the C.I.P. to carry out these tests and, when the tests have been passed successfully, the manufacturers of the items concerned then have the right to print the relevant mark of conformity on the package.

At present, the following countries are members of the C.I.P.:  
Belgium, Chile, Germany, Finland, France, Great Britain, Italy, Yugoslavia, Austria, Russia, Spain, Czech Republic, Hungary, United Arab Emirates

**System approval**

The powder-actuated tool and corresponding cartridges are tested by an independent testing agency (PTB = Physikalisch-Technische Bundesanstalt Braunschweig) for the purpose of system approval. Confirmation of approval is printed on the smallest packaging unit, as shown in the following example for 6.8/18 M10 red:

DX 750	PTB Sy 804 HR 56
DX 76	PTB Sy 813 HR 36
DX 76 PTR	PTB Sy 816 HR 36

The designation of the tool tested is given first (e.g. DX 76), followed by the testing agency (PTB), the system, i.e. the tool and applicable equipment (Sy 813), the cartridge manufacturer (HR), the number of tests (3) and the cartridge power level (6).

**Handling**

- Clean-Tec cartridges must be kept away from sources of heat and open flames.
- Clean-Tec cartridges must not be thrown or opened forcibly and must not be manipulated mechanically (e.g. pinched or squashed with pliers) or through application of heat.
- Clean-Tec cartridges may be sold or supplied only in the original packaging.
- Clean-Tec cartridges are to be used only in the approved powder-actuated tools for which they are intended (see PTB system approval on the package).
- Clean-Tec cartridges may be handled and used only by appropriately trained personnel.
- Good ventilation must be ensured at all times when working in enclosed spaces.
- A cartridge should not be reused after a misfire.
- The cartridge strip must always be removed from the tool at the end of the period of work.
- The points to be observed when using Hilti Clean-Tec cartridges are described in the material safety data sheet.

**Storage**

- Clean-Tec cartridges should always be stored in the original package. Direct exposure to heat or the rays of the sun must be avoided.
- Clean-Tec cartridges should be kept dry, i.e. avoid direct contact with water or moisture (e.g. rain, puddles of water, etc.).
- The cartridges belong to Storage Group 1.4S
- The temperature and air humidity in the storage room should be kept as constant as possible. A storage temperature of between 5°C and 25°C and a relative air humidity of less than 65% are recommended. Considerable fluctuations in temperature and humidity may result in a drop in performance or failure of the product.
- The cartridges should be stored in a locked room or container to prevent access by unauthorised persons.
- Cartridges should not be stored together with foodstuffs.
- Please also refer to section 7 of the material safety data sheet.

# Application Example 1.

Fastening to supports for shuttering to concrete.

## Construction “Kickerless Construction”.

The traditional ‘Kicker’ construction process can be significantly speeded up using quick innovative “Form Stops” fixed with Cartridge tools

### Traditional process includes:

Typically adds a least one extra day per floor waiting for kicker to be built, poured, cured and struck.

- Floor and kicker both need to be ‘scabbled’ increasing HAV risk
- Cannot complete main pour on same day.
- Labour intensive:
  - Floor ‘scabbled’ (HAV risk)
  - Kicker built
  - Concrete poured
  - One day to cure before kicker struck
  - Kicker struck and ‘repaired’ if necessary
  - Kicker ‘scabbled’ before work can start on next lift of shuttering.

## Traditional



Kicker often build using old materials and concrete from the end of the last ‘pour’.



Repair work is often required to kicker before next lift can proceed.

**Can save up to one day per floor in time and labour**

- Quick easy install, no kicker required
- Simpler setting out, after base is poured
- Blends into the concrete (grey colour)
- No risk of ‘kicker’ movement or repairs required
- Can pour concrete on the same day, significant time saving over traditional methods
- No weather restrictions
- No trailing cables for trip hazards
- Reduced HAV risk from scabbling
- Reduced risk of hand injury (cutting / hammering)



**Estimated savings:**

One day per floor can be saved ~  
15% of labour cost per floor

**Total installed cost comparison:**

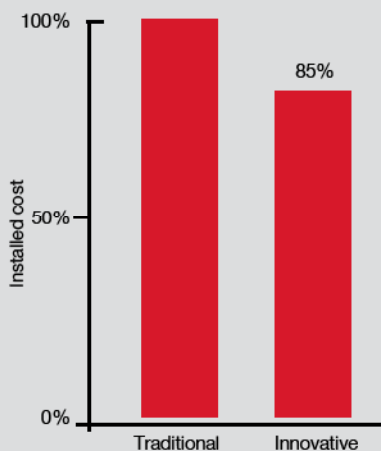

**Innovative**



X-FS Form Stop being installed.



Form Stop locates inner face of form work.



Outward pressure increases towards the bottom.

# Application Example 2.

Fastening to steel. Example: frame ties for brickwork.

Fixing Frame Ties and Head Restraints for supporting brickwork is a common application on many projects

## The Application

The brick tie is usually in a vented cavity and therefore will be subject to moisture over its lifetime; for that reason Stainless steel ties are typically used. As the base steel is a structural carbon steel, bi-metallic corrosion can occur if correct installation processes are not followed.

## Traditional Methods

- Stainless Steel ties are typically fixed using Self drill screws or Direct Fixing nails
- Screws are usually carbon steel giving a risk of bi-metallic corrosion if any contact with the stainless steel tie occurs.
- If a carbon steel screw or nail is used, isolation of the fastener from the stainless steel tie should be applied (this can be difficult to coordinate and supervise)
- Structural steel of varying strengths and thicknesses means that self drill screws will not always work and drill and tap may be required (a very slow process)
- Training cables can cause trip hazards, and poor weather can cause time delays when using electrical equipment.

## Traditional

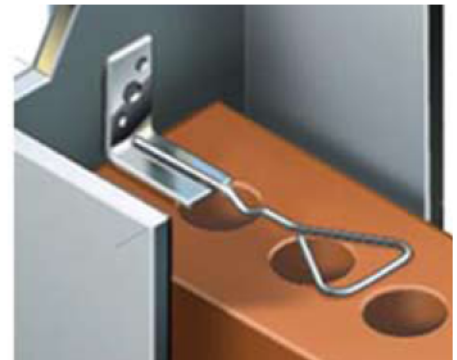

Frame tie.



Head restraint.



**Corrosion advice**

- When an electrochemically “less noble” material (i.e. carbon steel) comes in contact with a more “noble” material (i.e. stainless steel) accelerated corrosion will occur. The material loss of the noble partner is reduced, the loss of surface area of the less noble partner is increased. Prerequisite for this form of corrosion is an electrically conductive connection between these two materials.
- The rate of contact corrosion also depends on the ratio of the surface areas. The fastener transfers all the load from the cramp to the structural steel so loss of material from the fastener must be prevented.
- If the surface area of the less “noble” material (Carbon steel - fixing) is smaller than that of the more “noble” (Stainless steel - frame cramp) the corrosion rate of the less “noble” will be high.
- Please note that zinc is also less noble than stainless steel, so zinc plated or hot dip galvanised carbon steels will create the same situation. For further information, please see section on Corrosion or contact Technical Advisory Service on GB 0161 886 1144 IRE 1850 287 387.

**This means that:**

- If a carbon steel fastener comes in contact with a stainless steel tie, accelerated corrosion of the fastener will occur if moisture is present.

The Hilti X-QT is an all Stainless Steel Frame tie combined with an all Stainless steel nail. This means it can be directly fixed to the steel work and additional isolation of the fastener is not required.

**Benefits of using X-QT**

- High installation cost savings are possible due to the labour time saved.
- Greatly simplified installation process – no additional isolation components required.
- One single nail solution possible for all grades and thickness of structural steel(1).
- Free on site training is provided to ensure optimum performance and productivity is achieved

1. Note, on site trials will be required to determine suitability

**Time savings of up to 66% are possible using the Hilti X-QT**

**Innovative**

**Note:** This advice is consistent with an agreed amendment to the publication “Brickwork Cladding to Steel Framed Buildings” jointly published by The Brick Development Association and British Steel.



Hilti X-QT Quick Tie.

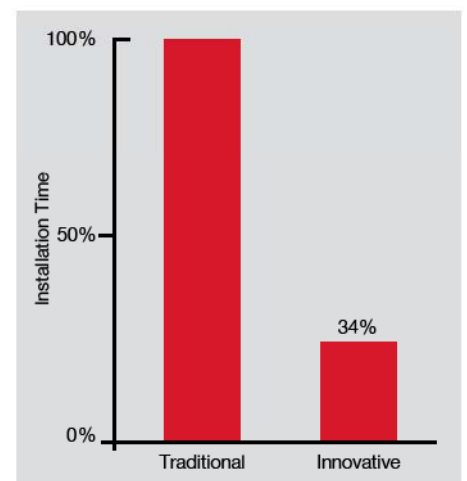

Significant time savings are possible.

# Application Example 3.

## Installation of Mechanical and Electrical Services. Based on Case Study conducted by BSRIA.

The following is an extract from a Case Study conducted by the Building Services Research & Information Association (BSRIA).

This example is based upon the labour and material cost to install 100 fixings into a concrete slab using powder-actuated fastening compared to traditional drilled holes and knock-in anchors.

Full Copy of the Case Study is available on request from Hilti.

### Traditional Methods:

- Traditional setting out methods require a line and plum bob to find the position of each fixing point
- Drilling overhead for a larger diameter hole for M10 fixing is slow and also causes potential Health & Safety risks of
  - Hand Arm Vibration
  - Dust from hole falling onto operative
  - Hand injury from setting the fixing
- Access is required from correctly erected platform which requires time to erect, check and with additional costs for hire or purchase
- Training cables from power tools can also cause trip hazards

### Traditional



Building Services.

**Benefits as identified by BSRIA**

- The setting out process can be significantly simplified and speeded up via modern Laser setting out tools
- When combined with Direct fastening Technology for the installation process, the overall productivity saving available is calculated at 36%
- The typical load range is between 40 - 90kg per fixing
- Simplified installation technique
- Installation cost reduction of 36% per fixing over traditional methods
- Installation labour reduction of 65% per fixing over traditional methods
- Free on-site training/certification by manufacturer
- Threaded rod, hanger and structural fixing can be installed in one operation
- Health and Safety risk reduced by:
  - No drilling
  - Reduced high level work when using installation extension arm

**Additional benefits include:**

- Almost dust free as no drilling required
- No training cables to cause trip hazards
- Items to be installed can be pre-assembled

**Total installed cost comparison: 100 fixings**

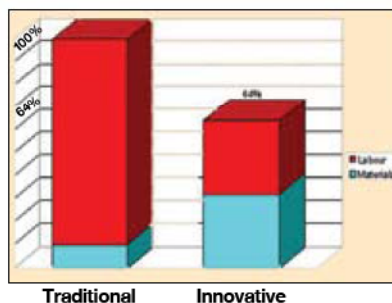

Installation costs	Traditional	Innovative
Labour	90%	32%
Materials	10%	32%
Total	100%	64%

The innovative installation shows a 36% cost saving over traditional methods.

**Innovative**



PR 25 laser combined with DX cartridge Tool on Pole Tool.



X-HS Rod Hanger fixed with Pole Tool.

# Application Example 4.

## Fastening of insulation using X-IE fasteners with SAM Ceiling and Partitions Ltd.

### Background:

SAM Ceiling & Partitioning are an Interior specialist based in the South West of England.

### Project:

EO2 Office Buildings in Cardiff, a three phase steel frame building in Cardiff City Centre.

### Application:

Fixing 120mm insulation to the underneath of metal decking at ground floor level. Area to be covered approximately 3,000m<sup>2</sup>.

### Challenge:

The key challenge was to keep within the time allocated. The programme was tight and SAM were looking for ways to speed up the process and make way for other contractors. Naturally cost was also crucial. The traditional method was to punch a plate and use a hammer type fixing 8mm.

The problem with this method was drilling a consistent hole depth and also the time taken to drill and fix the plate.

John Lewis - one of the installation team said of the direct fastening system:

**“Our method (X-IE) was 5 times quicker according to John and each phase took 5 days to complete using a two man team”.**



**Approach:**

Several demonstrations were conducted using Hilti X-IE Insulation fasteners into the metal decking. The trials were quick and effective and technical data for the fixings was provided to support the solution offered. The operators were very comfortable with the DX460 and felt this was preferable to the alternatives available.

**Summary:**

SAM were extremely happy with the result and will continue to use this method for such applications in future. The fact that the tool is versatile and can be used with the pole tool for fixing ceiling clips was also a key factor and we are now looking to maximise this opportunity.

SAM have estimated that using the Hilti X-IE fastening system meant that the job was completed 5 times faster

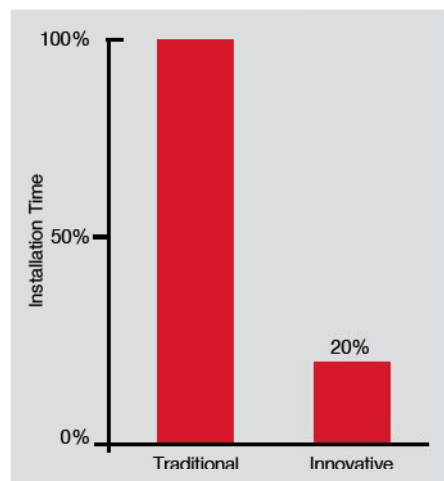

MD Mike Taylor said of the Hilti X-IE system

**“The Hilti X-IE fastening system has proved to be quick and reliable, it provided a very efficient and cost effect solution to the problem we faced.”**

**Innovative**



X-IE Insulation Fastening System.



# Application Example 5.

Fastening to liner trays using X-ENP nails with Lakesmere Ltd. Project Manager: Graham Clelland.

Lakesmere Ltd. are a large Building Envelope contractor who install roofs, walls, glazing and other architectural features. They are also an approved contractor for the installation of the Corus 'Kalzip'<sup>™</sup> roofing systems.

## Project:

The Shell Stanlow Oil Refinery on the Mersey in Cheshire. The requirement was to install 1371m<sup>2</sup> of a Kalzip 305 Aluminium roof system onto Structural steel 15-20mm thick. The normal solution would have been to fix using self drilling screws but it became apparent that screw fastening would be very slow due to the thicknesses of steel involved. Tests showed that each screw would take:

- 42 secs installation time to drill and fix to 15mm steel
- 16 seconds to fix to 10mm steel.

## Decision process

Direct Fastening (Hilti DX) was considered as the speed, technical backup and cost efficiency had already been proven on other projects. This would allow the fixing of the 'liner sheet' to the base structural steel overcoming much of the slow drilling work.

The very tight Health & Safety regulations on an oil refinery also meant gaining approval at the highest level and this was achieved via the Hilti and Kalzip's Technical Departments.

## Traditional



Liner Tray fixed to structural steel.



**Solution**

The Hilti X-ENP fastening system, which has been awarded a European Technical Approval (ETA-04/0101) was already an approved solution by Kalzip when fixing into structural steel (>6mm thick). The system is installed using a DX 76 cartridge tool and on this project allows the installation of: 10 magazined X-ENP nails in an average time of 40 seconds (i.e. 4 seconds per nail)

**Result**

The overall result was that the time it took to complete the overall job was 75% faster than using self drilling screws when fixing to steel > 15mm thick and 50% faster when fixing to steel 6-12mm thick.

As Graham McClelland himself said “Although the material outlay was more for the DX, the cost saving overall made it a more cost effective way of installing the structural liner deck”

Steve Johnson, Project Manager for another Lakesmere project also said of DX that it is

- “Far quicker installation over alternative methods means cost savings relating to labour”.
- “There is no metal swarf from ‘drill-point’ screws to cause damage to the coating surface / corrosion / staining”.
- “Productivity is increased as the lads can get the sheets laid very quickly”.
- “DX means a safer site as there are no leads or generators to worry about tripping over obviously a concern when working at heights”.

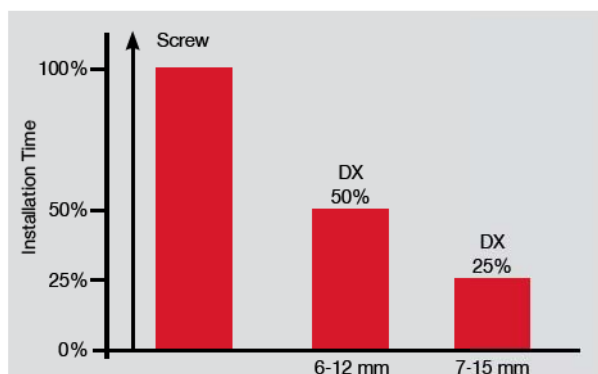

**Innovative**



The X-ENP nail has been awarded a European Technical approval ETA-04/0101.



Time and Cost saving benefits available using DX instead of self drill screws.

# Training.

Hilti provide certified training for all Hilti manufactured Direct Fastening tools and fittings. Hilti training equips the operator to use DX fastening techniques in most situations. Where specialist additions to the training are required these can sometimes be provided on site.

An example of the content of the Training is:

- The Direct Fastening system
- Operating principles
- Correct tool and fastening selection
- Operation and maintenance of tools
- Storage and care of equipment
- Awareness of current legislation
- Hands-on test firing of the tool

Successful trainees are presented with a certificate of training that will form part of the employer/employee training record. Hilti also help you to comply with the recent Construction, Design and Management (CDM) regulations. Please ask for further details on risk assessment.

This is designed to assist the site team to ensure that safe practices are followed at all times when carrying out Direct Fastening operations.

## CERTIFICATION OF TRAINING

NAME

DX/GX TOOL  Date:

This is to record that the above named person has been trained in the correct use of the above named Hilti DX/GX fastening tools.

Hilti (Gt. Britain) Ltd

Technical Sales person:

For advice and information TEL: 0800 886 100

### Certificate of Training on DX Cartridge Tools and GX Gas Tools

This is to record that \_\_\_\_\_ is over 18 years of age and has been trained in the following matters:

of operation using the tool	<table style="width: 100%; border-collapse: collapse;"> <tr> <td style="width: 50%;">1. Operating principle</td> <td style="width: 50%;">6. Waste procedure</td> </tr> <tr> <td>2. Basic maintenance</td> <td>7. Practical training and maintenance</td> </tr> <tr> <td>3. System selection</td> <td>8. Firing quality</td> </tr> <tr> <td>4. Applications</td> <td>9. Technical advice</td> </tr> <tr> <td>5. Safe use</td> <td>10. Instruction manual</td> </tr> </table>	1. Operating principle	6. Waste procedure	2. Basic maintenance	7. Practical training and maintenance	3. System selection	8. Firing quality	4. Applications	9. Technical advice	5. Safe use	10. Instruction manual
1. Operating principle	6. Waste procedure										
2. Basic maintenance	7. Practical training and maintenance										
3. System selection	8. Firing quality										
4. Applications	9. Technical advice										
5. Safe use	10. Instruction manual										

Technical instructor: \_\_\_\_\_ Date: \_\_\_\_\_

For and on behalf of Hilti (GB) (Sales) Limited Hilti (Gt. Britain) Ltd

Trainer's Signature: \_\_\_\_\_ Head Office: Hilti (GB) (Sales) Limited  
1 Trafford Wharf Road, Trafford Park  
Manchester M17 1 1TJ  
Telephone: 0800 886 100 Fax: 0161 275 2222  
Internet: <http://www.hilti.co.uk>

NOTE: An individual's competence depends not only on original training but also upon practical experience in the use of the tools in question. Advice is required to take in to account the relevant details.  
HILTI (GB) (Sales) Limited is not liable for any damage or injury.  
The use of the site for the fastening operation requires a competent person. Training is not to be used as a substitute for the user's own knowledge and experience. The user must be aware of the risks involved in the use of the tools in question. The user must be aware of the risks involved in the use of the tools in question.

# Risk Assessment Guidance - DX.

Should a risk assessment be required (CDM, HSE requirements), for a task involving the use of Hilti DX tools (cartridge tools), we offer the following guidance. The final column of the table illustrates the fact that risks also exist when considering alternative fixing methods. Clearly, any assessment must consider all risks involved when that particular task is being carried out. Therefore this is **not an exhaustive list** and should be used in conjunction with current legislation or good practice, such as the HSE publication “**Five steps to risk assessment**”. (Rev1) 4/02. [www.hse.gov.uk/pubns/indg163.pdf](http://www.hse.gov.uk/pubns/indg163.pdf).

**Reduce your risk of hand-arm vibration by using DX for lightweight fixings**

Risk	Potential problem	Measures to avoid problem	Parallel risks for other fixing methods
Spalling of base material	Fragments entering eyes or hitting skin	Eye protection to BS EN 166 code B required for operator and others in close proximity  Observe spacing and edge distance recommendations.	Swarf or concrete chips and dust drilling.
Noise	a) Hearing damage b) Occupied buildings	a) Ear defenders to BS EN 352	a) Applicable most other fixing methods.  b) Cartridge tools may be preferred for work in occupied buildings when compared with hammer drilling.
Tool recoil	Injury to hand / arm  Loss of foothold causing fall	Hold tool firmly with bent arms to absorb recoil.  User should stand on a firm base take suitable precautions to prevent a fall.	Torque reaction from drilling machine or screw gun.
Exhaust gases	Effects on respiratory system	Insignificant volume of harmful gases produced in normal use. For many fixes in a confined space, ensure adequate ventilation. CoSHH data available on request.	Dust from drilling, fumes from certain chemical anchors.
Tool misuse	Damage resulting from irresponsible use	Only trained, certificated personnel should use the system. Training available from Hilti (GB) Ltd.	Applicable to all other fixing methods.
Misfire	Unexpected ignition of mis-fired cartridge	Follow misfire procedure (as covered in training).	None.
Free-flight of fastener	Fastener injuries worker or bystanders	Use only low velocity, indirect acting tools. All standard Hilti DX tools are low velocity..	None.
Fixing failure	Failure under load	Follow correct procedure (see instructions and training). Observe Hilti technical data for the correct selection and number of fixings. Carry out site testing if data is unavailable or if the application is critical.	Applicable to all other fixing methods.

For cartridges we can provide a product data sheet and CoSHH data (Material safety Data Sheet). We can also assist with method statements for many applications. If you have any queries, please contact us and we will be pleased to offer further, specific advice.

# Lifetime Service for DX.

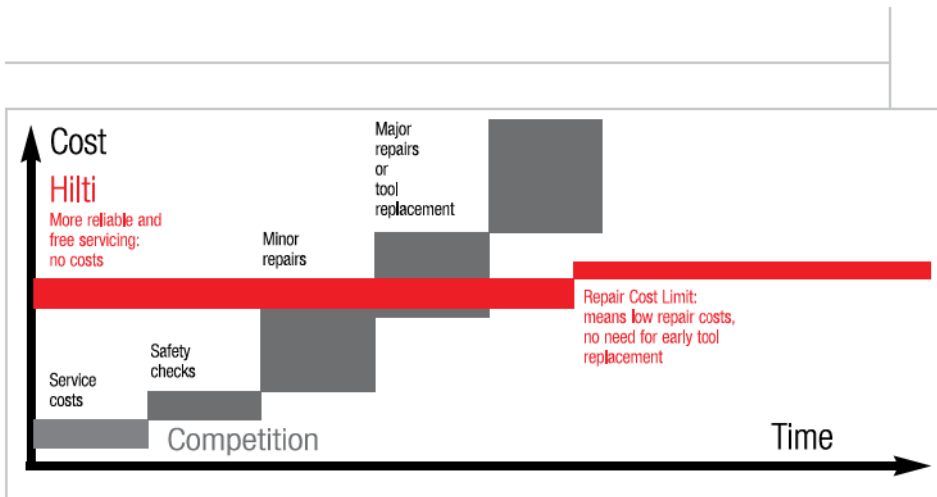

## Total Life Cycle Management 3 Steps to Total Confidence

	Hilti	Competition – You pay for:
Step 1	No Cost period	– Cost of wear & tear repair & maintenance & everything else
Step 2	Lifetime Repair Cost Limit	– High cost of major repairs means early tool replacement
Step 3	Lifetime manufacturers warranty	– Between 1 & 5 years

Piston stop rings excepted.

Tool Life Cycle Management is unique to Hilti. We are confident about our tools reliability that we can provide tool life cycle management. Its purpose is to give our customers the benefit of the most reliable tools that enhance productivity, open access to technical and engineering expertise coupled with innovation.

<b>HILTI</b>	Up to <b>2</b> Years
<b>LIFETIME SERVICE</b>	<b>NO COSTS</b>
Lifetime	Lifetime
<b>REPAIR COST LIMIT</b>	<b>MANUFACTURERS WARRANTY</b>

**New attractive service offering for DX tools:**

**Lifetime Manufacturers Warranty**

2 Years No Cost cover \*

- \* DX 860-ENP, 1 year No Cost.
- \* Only 'wear parts' excluded – Piston, Stop Ring/Buffer

Lifetime Repair Cost Limit

Repairs - additional 6 months 'No Cost' cover

**Lifetime maintenance and inspection package available**

Maintenance / Inspection package includes:

- Cleaning of tool, inspection of tool, new piston and stopper, shipping charges (pick-up and delivery)
- For details see "Hilti Tools - making you money."



<b>HILTI</b>	Up to <b>2</b> Years
<b>LIFETIME SERVICE</b>	<b>NO COSTS</b>
Lifetime	Lifetime
<b>REPAIR COST LIMIT</b>	<b>MANUFACTURERS WARRANTY</b>

# CE Identification mark on PAT tools.

- Feb. 2010, the world's first CE-marked PAT tool, a DX 460 MX, has left a Hilti plant.
- By the end of 2010, the CE identification mark will be adopted to all DX tools except the UW10 (underwater tool)
- The CE identification icon declares that the Hilti Powder actuated tool complies with the provisions of the Machine Directive 2006/42/EC. From now on this will co-exist with the PTB icon that declares that the tool is approved by the standards of the CIP regulation.
- CE identification will replace CIP approval within a 18 month transition period in all EU-and EFTA countries

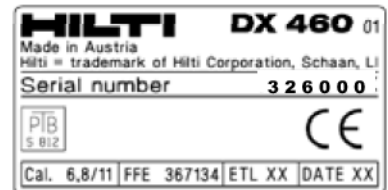

## CE Explaining the CE identification mark

What is new?	Benefits
Tool complies with "Machinery directive"	It is a tool, not a weapon
Consistent identification (similar to power tools)	Simplify ISO certification
No more obligation for recurring inspection (Germany, others to follow)	Less effort in tool maintenance
Safety relevant instructions and data publication in operator's manual	Enhance user health and safety
Strict enforcement of clear-cut international guidelines	High quality standard guaranteed

**CE** The Hilti Powder Actuated tool complies with the provisions of the Machine Directive 2006/42/EC.

 The Hilti Powder Actuated tool has been system tested and type approved according to C.I.P. regulation.

## Self certification (from 02/10) Approval

The CIP regulation continues to apply to C.I.P. member states outside the EU and EFTA judicial area.



# Approvals.

The DX Fastening Systems below carry product approvals, or the product data has been derived in accordance with the standards or guidelines listed.

<b>CSTB</b>		<b>Centre Scientifique et Technique du Bâtiment</b> (Building Science and Technology Centre) ENP2, ENPH2, ENP2K
<b>DIBt</b>		<b>Deutsches Institut für Bautechnik</b> (German Institute of Building Technology) ENP2, ENPH2, X-IE (special version), X-CR, X-CRM, X-HS, X-CC
<b>DNV</b>		<b>Det Norske Veritas</b> (Offshore Approval, ignition test) DX 450
<b>FM</b>		<b>Factory Mutual</b> ENP2, ENPH2, ENP2K, ENKK
<b>ICBO</b>		<b>International Conference of Building Officials</b> ENP2, ENPH2, ENP2K, ENKK, studs (not X-CRM), X-DNI, X-EDNI, ENK, EDS, DS, X-ZF
<b>Lloyds</b>		<b>Lloyds Register of Shipping</b> (Offshore Approval, ignition test) DX 460, DX 351
<b>ONORM</b>		<b>Oesterreichische Norm</b> (Austrian Standard) X-HVB
<b>SDI</b>		<b>Steel Deck Institute</b> ENP2, ENPH2, ENP2K
<b>SOCOTEC</b>		<b>Société de Contrôle Technique</b> (Technical Controlling Body) X-HVB, X-IE, X-HS, X-CC
<b>SZS</b>		<b>Schweizerische Zentralstelle für Stahbau</b> (Swiss Steel Construction Association) X-HVB
<b>UL</b>		<b>Underwriters Laboratories</b> ENP2K, ENKK, studs (not X-CRM)
<b>TZÚS</b>		<b>CZECHIA</b> X-HVB

Technical data (design loads, application restrictions, etc.) presented in these approvals / guidelines reflect specific local conditions and may differ from data published in this Specifier's guide. If the project is subject to a particular approval / guideline, then that data has precedence over the data in this guide. For copies of approvals, please contact the Hilti Technical Advisory service.

# Load Data.

Note: this data is a summary of the full technical data for the product which should be consulted for all safety critical applications.

Part fastened to steel base	Thickness of part fastened (mm)	Nrec (kN)	Vrec (kN)	X-CR / P8	X-CR / S12	EDS / DS	X-U P8	X-U S12
Wood	24	0.3	0.6	•	•	•		
Plywood	16	0.6	0.6	•	•	•		
Sheet Steel	0.75	1.4	1.2					•
Sheet Steel	1.00	1.8	1.8					•
Sheet Steel	1.25	2.2	2.6					•
Sheet Steel	2.00	2.2	2.6					•
Sheet Steel $\geq 370$ N/mm <sup>2</sup>	0.75	1.0	1.2				•	
Sheet Steel $\geq 370$ N/mm <sup>2</sup>	1.00	1.2	1.8				•	
Sheet Steel $\geq 370$ N/mm <sup>2</sup>	1.25	1.5	2.6				•	
Sheet Steel $\geq 370$ N/mm <sup>2</sup>	2.00	2.0	2.6				•	
Sheet Steel $\geq 370$ N/mm <sup>2</sup>	0.75	1.4	1.1		•			
Sheet Steel $\geq 370$ N/mm <sup>2</sup>	1.00	1.6	1.4		•			
Sheet Steel $\geq 370$ N/mm <sup>2</sup>	1.25	1.8	1.7		•			
Sheet Steel $\geq 370$ N/mm <sup>2</sup>	2.00	2.2	2.0		•			
Sheet Steel $\geq 370$ N/mm <sup>2</sup>	0.75	1.0	1.1	•				
Sheet Steel $\geq 370$ N/mm <sup>2</sup>	1.00	1.2	1.4	•				
Sheet Steel $\geq 370$ N/mm <sup>2</sup>	1.25	1.5	1.7	•				
Sheet Steel $\geq 370$ N/mm <sup>2</sup>	2.00	2.2	2.0	•				
Aluminium Steel $\geq 210$ N/mm <sup>2</sup>	0.80	0.4	0.4	•				
Aluminium Steel $\geq 210$ N/mm <sup>2</sup>	1.00	0.6	0.6	•				
Aluminium Steel $\geq 210$ N/mm <sup>2</sup>	1.20	0.8	0.9	•				
Aluminium Steel $\geq 210$ N/mm <sup>2</sup>	1.50	1.1	1.4	•				
Aluminium Steel $\geq 210$ N/mm <sup>2</sup>	2.00	1.6	1.7	•				
Aluminium Steel $\geq 210$ N/mm <sup>2</sup>	0.80	0.6	0.4		•			
Aluminium Steel $\geq 210$ N/mm <sup>2</sup>	1.00	0.8	0.6		•			
Aluminium Steel $\geq 210$ N/mm <sup>2</sup>	1.20	1.1	0.9		•			
Aluminium Steel $\geq 210$ N/mm <sup>2</sup>	1.50	1.6	1.4		•			
Aluminium Steel $\geq 210$ N/mm <sup>2</sup>	2.00	1.9	1.7		•			

























## •General nail load data for concrete base (pullover) recommended resistances

Part fastened to concrete base	Thickness of part fastened (mm)	Nrec (kN)	Vrec (kN)	X-CR / P8	X-CR / S12	EDS / DS	X-U P8	X-U S12
		Min 5 fixings per part fastened	Min 5 fixings per part fastened	Min 8 fixings per part fastened	Min 8 fixings per part fastened			
Wood	24	0.4	0.4			•	•	•
Plywood	16	0.4	0.4			•	•	•
Wood	24			0.6	0.6	•	•	•
Plywood	16			0.6	0.6	•	•	•

\* When using the X-CR fastener, a stainless steel penny washer of an equivalent size should be used to avoid any potential bimetallic reaction between the fastener and the washer.

Note: when using X-U nails values are based on 27mm embedment depth.

# Quick Reference Guide.

Description	Shank Length (MM)															Recommended Base Material		
	9	12	14	15	16	19	22	27	32	37	42	47	52	57	62	72	Concrete	Steel
	High performance pin for medium base materials * <b>X-U</b> 					■	■	■	■	■	■	■	■	■	■	■	■	
High performance pin for concrete <b>DS</b> 								■	■	■	■	■	■	■	■	■		
Standard pin with pre-mounted washer for soft to medium base material * <b>X-C</b> 																		
High performance pin for hard steel * <b>X-DAK</b> 				■														
High performance pin for steel <b>EDS</b> 						■	■	■										
316 stainless steel equivalent for corrosive environments <b>X-CR</b> 			■		■	■	■	■	■	■	■	■	■	■	■	■		
Breakaway pin for form work * <b>X-CT</b> 												■	■	■	■	■		
Soft plastic washer for attaching thin membrane materials to concrete * <b>X-SW</b> 										■		■	■	■	■			
Stud for temporary attachments to concrete <b>X-MB, M8, M10</b> <b>X-CR MB</b> • 								■	■	■	■	■	■	■	■	■		
Stud for temporary attachments to steel <b>EM6, EM8</b> <b>X-CR MB</b> • 		■	■	■														
Stud for temporary attachments to concrete <b>M10</b> 								■	■	■	■	■	■	■	■	■		
Stud for temporary attachments to steel <b>EM10</b> 				■														
High performance ceiling clip for medium base materials <b>X-CC</b> 					■	■	■	■	■	■	■	■	■	■	■	■		
Hanger clip for hanging threaded rod from concrete base materials <b>X-HS</b> • <b>M6, M8, M10</b> 						■	■	■	■	■	■	■	■	■	■	■		
Holder for suspending CAT 5 cables from concrete ceilings - flame retardant option <b>X-ECH</b> 											■	■	■	■	■	■		
Cable clamp for securing cables or conduits to ceilings and floors <b>X-EKB</b> 												■	■	■	■	■		
Trunking fastener for installing plastic (PVC) electrical trunking 20mm and wider <b>X-ET</b> 					■	■	■	■	■	■	■	■	■	■	■	■		
Conduit clip <b>X-FB</b> 					■	■	■	■	■	■	■	■	■	■	■	■		
Flexible conduit clip for flexible conduits in electrical installations <b>X-EFC</b> 																		
Plastic fastener for attaching insulation materials 25 - 125mm thick <b>X-IE</b> 													■	■	■	■		
Disc for attaching grating 25 - 50mm thick to steel frames <b>X-FCM</b> <b>X-FCM R</b> • 				■														
Disc for attaching checker plate to steel frames <b>X-FCP</b> 	■			■														
DX fastener for high strength hard concrete <b>DX Kwik</b> 										■		■	■	■	■	■		
Marine fastener for fastening directly to coated / treated steel <b>X-BT-R</b> 																		

\* Magazine Option. • Stainless Steel Option. ■ Denotes standard sizes available.

**Hilti. Outperform. Outlast.**

**Hilti (Gt. Britain) Limited** | 1 Trafford Wharf Road | Trafford Park | Manchester M17 1BY  
Freephone: 0800 886 100 | Freefax: 0800 886 200 | [www.hilti.co.uk](http://www.hilti.co.uk)

**Hilti (Fastening Systems) Limited** | Unit C4 | North City Business Park | Dublin 11  
CallSave: 1-850-287-387 | Freefax: 1-800-654-600 | [www.hilti.ie](http://www.hilti.ie)