



DIRECT FASTENING TECHNOLOGY MANUAL 2019



Contents

Hilti Direct Fastening System

Part 1:	Direct fastening principles and technique	9
1. Introduction		9
1.1	Definitions and general terminology	9
1.2	Reasons for using direct fastening	9
1.3	Direct fastening applications	11
2. The direct fastening system		12
2.1	Fasteners	13
2.2	Manufacturing process	14
2.3	Fastener raw material	15
2.4	Types of Hilti direct fastening tools	16
2.5	Operating principles	18
3. Health and safety		21
3.1	Operator safety	21
3.2	Fastening safety	26
3.3	Quality of installation	27
4. Corrosion		29
4.1	Corrosion protection of direct fastening systems	29
4.2	Fastener selection	31
5. Steel base material		36
5.1	Anchoring mechanisms	36
5.2	Factors influencing pull-out resistance	38
5.3	Suitability of the steel for fastening	43
5.4	Application limit diagrams	44
5.5	Thin steel base material	45
5.6	Types of load and modes of failure	46
5.7	Effect of fasteners on structural steel	53
6. Concrete base material		58
6.1	Anchoring mechanisms	58
6.2	Factors influencing resistance to pull-out	60
6.3	Effect of time on pull-out resistance	63
6.4	Effect on concrete components	64
7. Masonry base material		65
7.1	General suitability	65

8. Temperature effects on the fastening	66
8.1 Effect of low temperatures on fasteners	66
8.2 Effect of low temperatures on fastenings to steel	67
8.3 Fire rating of fastenings to steel	69
8.4 Fire rating of fastenings to concrete	71
9. Design concepts	73
10. Determination of technical data for fastening design	75
10.1 Fastenings to steel	75
10.2 Profile sheet fastenings	76
10.3 Fastenings to concrete (standard DX / GX / BX)	77
10.4 DX fastenings to concrete (DX-Kwik)	79
10.5 Fastener design in the USA and Canada	80
Part 2: Fastener selection guide	81
1. Selecting the right fastener	82
2. Concrete fastener selection	84
3. Nomenclature / symbols	92
4. Tips for users	95
5. Nail and stud designation	101
Part 3: Tools and equipment	107
Powder-actuated tool	109
DX 460-MX Powder-actuated tool for fastening collated nails	109
DX 460-F8 Powder-actuated tool for fastening single nails	109
DX 460-SM Powder-actuated tool for fastening metal decks	112
DX 5 Digitally enabled powder-actuated tool for fastening collated nails	113
DX 5 F8 Digitally enabled powder-actuated tool for fastening single nails	113
DX 5 IE Powder-actuated tool for fastening insulation	116
DX 5 GR Powder-actuated tool for fastening gratings	116
DX 5 SM Powder-actuated tool for fastening metal decks	116
DX 5 F10 Powder-actuated tool for fastening W10 threaded studs	116
DX 351 Powder-actuated tool for interior finishing applications	118
DX 351 F8 Powder-actuated tool for interior finishing, mechanical and electrical applications	118
DX 351 BT Powder-actuated tool for fastening X-BT threaded studs	119
DX 351 BTG Powder-actuated tool for fastening gratings	119
DX 2 Semi-automatic powder-actuated tool for fastening single nails	120
DX 76 PTR Powder-actuated tool for fastening metal decks with collated nails	121

DX 76 PTR	Powder-actuated tool for fastening metal decks with single nails	121
DX 76 PTR	Powder-actuated tool for fastening metal decks on concrete – DX-Kwik	122
DX 76 PTR	Powder-actuated tool for fastening HVB shear connectors	122
DX 76 PTR	Powder-actuated tool for fastening gratings and checker plates	123
DX 76 PTR	Powder-actuated tool for fastening heavy duty applications	123
DX 76	Powder-actuated tool for fastening metal decks with collated nails	
DX 76	Powder-actuated tool for fastening metal decks with single nails	124
DX 76	Powder-actuated tool for fastening metal decks on concrete – DX-Kwik	125
DX 76	Powder-actuated tool for fastening HVB shear connectors	125
DX 76	Powder-actuated tool for fastening gratings and checker plates	126
DX 76	Powder-actuated tool for fastening heavy duty applications	126
DX-860	Powder-actuated tool for fastening metal decks	127
DX 76	Powder-actuated tool for fastening metal decks	127
DX 9	Digitally enabled powder-actuated tool for fastening metal decks	128
DX 9	Digitally enabled powder-actuated tool for fastening metal decks	128
Cartridges	Propellants for powder-actuated tools	129
Gas-actuated tool		130
GX 90 WF	Gas-actuated tool for wood framing	130
GX 120	Gas-actuated tool for interior finishing applications	131
GX 120-ME	Gas-actuated tool for mechanical and electrical applications	131
GX 3	Gas-actuated tool for interior finishing and building construction applications	132
GX 3-ME	Gas-actuated tool for mechanical and electrical applications	132
GX 2	Gas-actuated tool for interior finishing and building construction applications	133
Gas cans		133
Battery-actuated tool		134
BX 3-BTG	Battery-actuated tool for fastening gratings	134
BX 3-IF	Battery-actuated tool for interior finishing and building construction applications	135
BX 3-ME	Battery-actuated tool for mechanical and electrical applications	135
BX 3 02	Battery-actuated tool for mechanical and electrical applications	136
BX 3 02	Battery-actuated tool for interior finishing, mechanical and electrical and building construction applications	136

Part 4:	Fasteners	137
Siding and decking nail		139
X-ENP	Siding and decking nail	139
SDK2, PDK2	Sealing cap for cladding fastening	147
X-ENP2K	Siding and decking nail	149
X-HSN 24	Diaphragm decking nail	155
NPH	Siding and decking nail	159
Shear connectors		163
X-HVB	Shear connector	163
General purpose nails		171
X-U	Nail for fastening to concrete and steel	171
X-P	Nail for fastening to concrete and steel	181
X-C	Nail for fastening to concrete and sand lime masonry	187
X-S	Nail for fastening drywall track to steel	193
EDS	Nail for fastening to steel	203
Application specific nails		209
X-R	Stainless steel nail for fastening to steel	209
X-CR	Stainless steel nail for fastening to steel	215
X-CR	Stainless steel nail for fastening to concrete, sand lime masonry and steel	219
X-CT	Nail for forming or other temporary use	225
DX-Kwik, X-M6 H, X-M8 H and DNH, X-DKH	Threaded stud and nail	229
Threaded studs for fastenings		229
X-M6 H, X-M8 H, DX-Kwik	Threaded studs	229
X-EM6H, X-EW6H,		239
X-EF7H, X-EM8H,		239
X-EM10H,		239
X-EW10H	Threaded stud for fastening to steel	239
X-BT	Stainless steel threaded stud	245
X-BT	New Generation stainless steel threaded stud	253
X-BT-MR-N	Stainless steel threaded stud for narrow through hole	261
X-BT-MF	Composite threaded stud	269
S-BT	Screw-in stainless steel and carbon steel threaded stud	275
X-ST-GR	Stainless steel threaded stud for fastening to steel	285

X-CRM	Stainless steel threaded stud for fastening to concrete and steel	291
X-BT-ER	Stainless steel threaded stud for electrical connection	297
S-BT-ER, S-BT-EF	Screw-in stainless steel and carbon steel threaded stud	303
X-FCM	Grating fastening system	317
X-FCM-R HL	Grating fastening system	327
X-FCI-M	Grating fastening system	332
X-FCS	Grating fastening system	340
X-GR	Grating fastening system	348
X-PGR-RU	Grating fastening system (pre-drilled)	354
X-MGR	Grating fastening system	358
X-FCP	Checker plate fastening system	362
Fasteners for insulation soft material and formwork		368
X-IE-G	Insulation fastener	368
X-IE, X-IE-E	Insulation fastener	372
X-IE-H	Insulation fastener for hard board	376
XI-FV ETICS	Insulation fastener	380
X-SW 30, X-SW 60	Soft washer fastener	386
X-FS	Form stop	390
X-DFS	Double form stop	392
X-DFC	Double fire clip	396
Gas tool fastening systems		400
X-EGN, X-GHP, X-GN	Fastener for gas-actuated tool	400
GX 3 System	Fastener for interior finishing, building construction, mechanical and electrical application	406
GX 2 System	Fastener for interior finishing applicatio	418
Battery-actuated tool fastening systems		422
BX 3 System	Fastener for interior finishing, building construction, mechanical and electrical application	422
BX-Kwik	Electrical hanger system	432
X-HS and X-CC	Threaded hanger and loop hanger system	436
Hanger fasteners		436
X-EHS MX, X-ECC MX	Electrical hanger system	442
X-DHS MX	Pipe support system	446

X-HS-W	Wire hanging system	450
Electrical fasteners		454
X-EKB, X-ECH	Electrical fastener	454
X-ECH-FE MX, X-EKB-FE MX	Circuit integrity fastener	460
X-FB, X-DFB, X-EMTC	Electrical conduit fastener	464
X-FB-E,		468
X-DFB-E	Electrical conduit fastener	468
X-UCS MX	Universal conduit saddle	472
X-UCS-S MX	Universal conduit saddle for rigid pipe	476
X-ECT MX, X-UCT MX, X-EKS MX	Electrical cable tie and conduit clip fastener	480
X-UCT-E MX	Universal cable tie holder	484
X-ET	Nail for fastening plastic electrical cable tray and junction box	488
Wood nails		492
GX-WF	Wood framing nail	492
Summary of Approvals – Direct Fastening		503
Approvals		503
Nails → Approvals		503
Approvals → Nails		525



Part 1:

Direct fastening principles and technique

1. Introduction

1.1 Definitions and general terminology

Hilti direct fastening technology is a technique in which specially hardened nails or studs are driven into steel, concrete or masonry by a piston-type tool. Materials suitable for fastening by this method are steel, wood, insulation and some kinds of plastic. Fastener driving power is generated

by a power load (a cartridge containing combustible propellant powder, also known as a “booster”), combustible gas or by a battery. During the driving process, base material is displaced and not removed. In Hilti terminology, DX stands for “powder-actuated”, GX for “gas-actuated” and BX stands for “battery-actuated” systems (i.e. propellant free).”

1.2 Reasons for using direct fastening

“The illustrations below show some of the main reasons why many contractors take

advantage of the benefits of powder-, gas- or battery-actuated fastening.

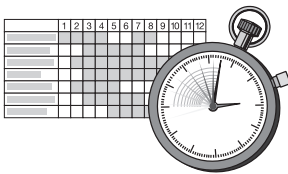

Speed is important.

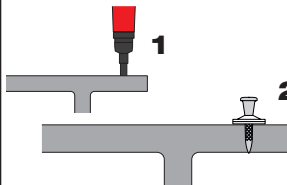

An easy-to-use, uncomplicated fastening system is required.

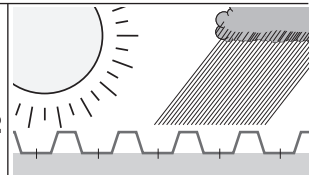

A weather-independent fastening system is required.



Electric power is not available or electric cables would hinder the work.

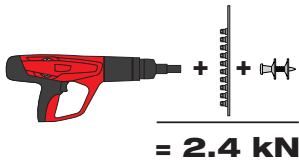

A complete fastening system with assured strength is required.



Drilling is not viable because of noise.

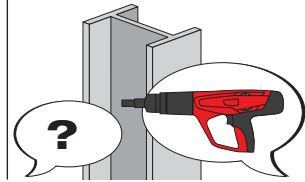

Drilling would be too difficult.

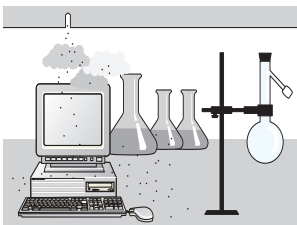

Drilling would cause too much dust.

In addition, there are specific reasons why contractors may use battery-actuated fastening:



Gas cans or combustion systems are not allowed

1.3 Direct fastening applications

Typical applications for powder- or gas-actuated fastening are shown in the illustrations below:

- Fastening thin metal sheets: roof decking wall liners and floor decking
- Fastening thicker steel members: e.g. metal brackets, clips
- Fastening soft materials such as wooden

battens or insulation to steel, concrete or masonry

- Threaded studs for suspended ceilings, installing building services, bar gratings or chequer plate floors
- Connections for composite structures: fastening nailed composite shear connectors

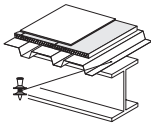

Roof decking

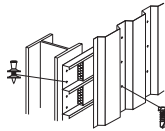

Wall liners

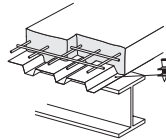

Floor decking

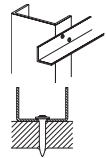

Metal brackets, clips and tracks

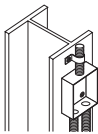

Fixtures for mechanical and electrical installations

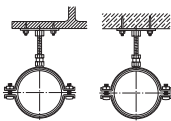

Hangers with threaded connectors

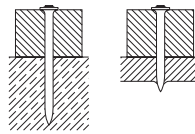

Wooden battens fastened to steel or concrete

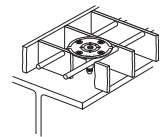

Grating fastenings

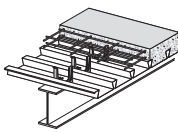

Shear connectors

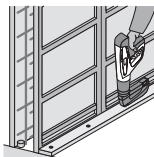

System formwork

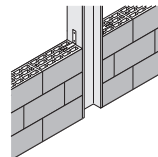

Wall-tie to steel and concrete

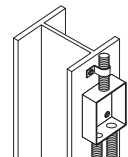

Mechanical and electrical fixtures

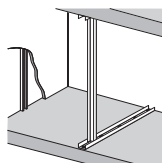

Drywall track to concrete and steel

2. The direct fastening system

The fastener, tool and driving energy form a fastening system with its own specific characteristics. Examples of Hilti direct

fastening system components are shown below.

Fasteners	Fastening tools	Driving energy
		
Powder-actuated tool		
		
Gas-actuated tool		
		
Battery-actuated tool		

2.1 Fasteners

Fasteners can be classified in three general types: nails, threaded studs and composite fasteners.

Nails

Siding and decking nails



General purpose nails

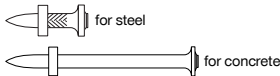

Threaded studs

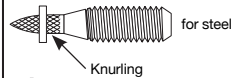

Blunt-ended fastener
(requires pre-drilling)



Pre-mounted fasteners

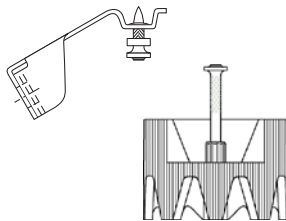

Multi-part fasteners

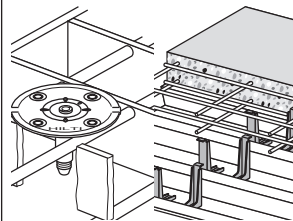

The nails used (also known as drive pins) are of a special type equipped with washers to meet the needs of the application and to provide guidance when driven. Threaded studs are essentially nails with a threaded upper section instead of a head. Composite fasteners are an assembly consisting of a nail with an application-specific fastening component such as a clip, plate or disk made of metal or plastic.

Siding and decking nails can be recognized by their washers which are specially designed to hold down the metal sheets and to absorb excess driving energy. Fasteners designed for driving into steel usually have

knurled shanks which increase their pull-out resistance. Fasteners for use on concrete have longer shanks than those for use on steel. Threaded studs may have either a metric (M6, M8 or M10) or Whitworth ($1/16''$, $5/16''$ or $3/8''$) thread.

Nails and threaded studs are commonly zinc-plated for resistance to corrosion during transport, storage and construction. As this degree of protection is inadequate for long-term resistance to corrosion, use of these zinc-plated fasteners is limited to applications where they are not exposed to the weather or a corrosive atmosphere during their service life. The zinc layer on

fasteners driven into steel is, in fact, a disadvantage in that it reduces pull-out resistance. For this reason, the thickness of zinc on the fastener must be optimized to ensure good corrosion protection as well as high holding power. During production, tight control of the galvanizing process is necessary to prevent excess zinc thickness and thereby poor fastening performance. Fasteners must be 2 to 3 times harder than the material into which they are driven. The tensile strength of structural steel is

commonly between 400 and 600 MPa. Fasteners for use on steel thus require a strength of approximately 2000 MPa. As Rockwell hardness is much easier to measure than strength, but good correlation exists between hardness and strength, this characteristic is used as a parameter in the specification and manufacturing of the fasteners. In the table below, HRC hardness is given for a range of tensile strengths (DIN 50150).

Tensile strength									
(MPa)	770	865	965	1810	1920	1995	2070	2180	2215
HRC	20.5	25.5	30	52.5	54	55	56.5	58	59

2.2 Manufacturing process

Standard hardened steel fasteners

Almost all power-actuated fasteners used throughout the world are manufactured from carbon steel wire which is subsequently thermally hardened to provide the strength needed for driving into steel and concrete. In nail manufacturing, shank diameter is determined by the wire diameter used. Threaded studs are made from wire corresponding to the required thread diameter. The manufacturing process, which is summarized in the diagram below, consists of cutting the wire to length, shaping the head, knurling, forging or thermo pulling the point, hardening, galvanizing and assembling with washers. The process of hardening the steel to more than HRC 50 combined with the zinc plating presents a risk of hydrogen embrittlement. This risk is mitigated by heat-treating the

galvanized product at the optimum temperature for the correct time. Galvanized and heat-treated fasteners are subjected to impact bending tests to check the effectiveness of the process. Depending on their intended application, some fasteners are additionally sampled and tested under tension and shear.

Manufacturing Process

Standard zinc-coated fasteners

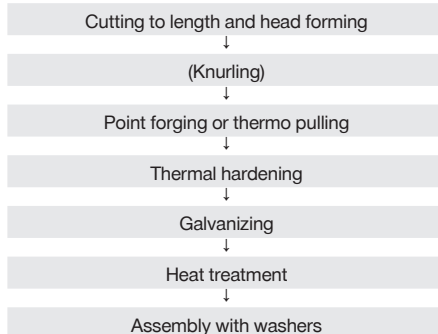

Stainless steel fasteners

Hilti introduced the first powder-actuated stainless steel fastener in 1994. These fasteners, which are not thermally hardened, are manufactured from special stainless steel wire with an ultimate tensile strength of 1850 MPa. One effect of using steel of such high strength as a raw material is that the forming and forging processes present greater technical difficulties. These fasteners, on the other hand, suffer no

risk of hydrogen embrittlement and their strength decreases only very slightly when subjected to high temperatures such as in a fire.

Manufacturing Process

Stainless Steel Fasteners

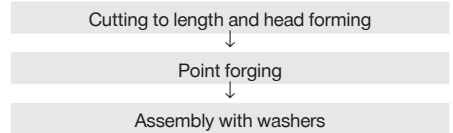

2.3 Fastener raw material

Hilti standard zinc plated fasteners are made from carbon steel wire with an ultimate tensile strength of 590 to 760 MPa.

Hilti X-CR / X-BT stainless steel fasteners are made from high-strength nitrogen alloyed stainless steel wire (Hilti designation CR500) or ferritic-austenitic corrosion resistant duplex steel 1.4462.

Nickel and chromium are the components of stainless steel that make it resistant to corrosion. CR500 steel is compared to commonly used stainless steels like AISI 304 and 316 (European A2 and A4) in the graph at the right. Note that CR500 steel contains considerably more nickel and chromium than both 304 and 316.

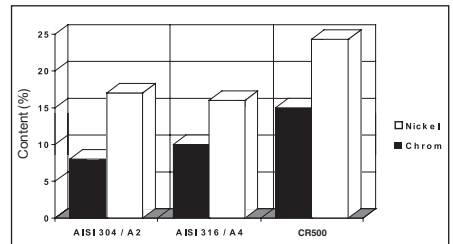

Another comparison of interest is the difference in ultimate tensile strength, as shown in the graph at the right.

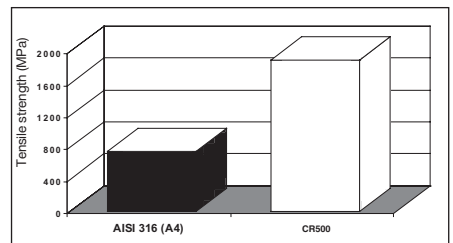

2.4 Types of Hilti direct fastening tools

Hilti currently offers three types of direct fastening tools: powder-actuated, gas-actuated and battery-actuated.

2.4.1 Powder-actuated tools



These tools rely on cartridges of different power levels as propellant. When ignited, the cartridge transfers energy to a piston which, in turn, drives the fastener into the base material.

All Hilti powder-actuated tools are classified as low-velocity tools.

Class of powder-actuated tool	Average test velocity in m/s [fps]	Maximum single test velocity in m/s [fps]
Low-velocity	100 [328]	108 [354]
Medium-velocity	150 [492]	160 [525]
High-velocity	>150 [492]	>160 [525]

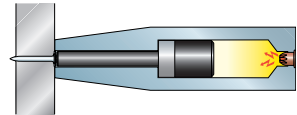

2.4.2 Gas-actuated tools

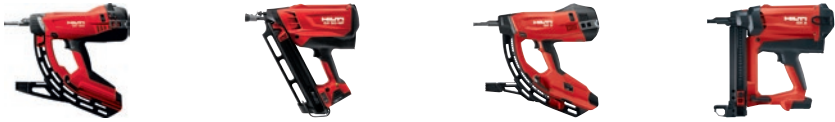

These tools rely on gas as propellant. Expanding the gas transfers energy to a piston which, in turn, drives the fastener into the base material.

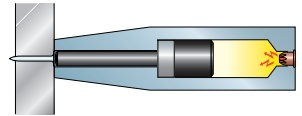

Hilti manufactures gas-actuated tools using two distinct technologies. The first (used notably in models GX 2 and GX 90 WF) uses a fan to mix the propellant with ambient air. The second (used notably in the GX 120 and GX 3) uses a Hilti-designed mechanism requiring no external power to mix the gas and air in the combustion chamber.

2.4.3 Battery-actuated tools



This tool is propellant-free. The energy moving the piston is generated by an electrical motor, two springs and a belt. The only source of energy required is a 22V battery which is interchangeable with other tools from the Hilti 22V platform family.



2.5 Operating principles

All Hilti direct fastening tools feature a piston. There are three ways the piston can come into contact with the fastener when an operator triggers a tool – referred to as operating principles. They are described in the diagram below.

It is important to bear in mind that the operating principle used for a given fastening point modifies the application's limit, particularly when fastening on steel.

Operating principle	Characteristics	
Co-acting operation	<ul style="list-style-type: none"> • $X > 0$; $Y = 0$ • Highest application limit • Lowest recoil 	
Impact operation	<ul style="list-style-type: none"> • $X = 0$; $Y > 0$ • Lower application limit • Higher recoil 	
Contact operation	<ul style="list-style-type: none"> • $X = 0$; $Y = 0$ • Lowest application limit • Highest recoil 	

It should be noted that 100% co-acting operation in Hilti tools can be only achieved by pushing the fastener all the way against the piston with a ramrod or, if the tool is so designed, with a built-in ramrod mechanism. Tools with nail magazines cannot operate with 100% co-action because of the need for clearance between the piston end and the collated nail strip. Some single-shot tools allow the operator to make an impact-type tool work as a co-acting tool by using a ramrod.

2.5.1 Cartridges (power loads, boosters)

Cartridges for powder-actuated fastening tools are available in various standard sizes and each size is available in up to 6 power levels. In the United States, the powder in a cartridge, the sensitivity of the primer, and the cartridge dimensions are governed by technical data published by the Powder-Actuated Tool Manufacturers Institute, Inc.

(PATMI). PATMI defines the power level by the velocity measured in a standard test in which a standardized 350 grain [22.7gram] cylindrical plunger is fired from a standardized apparatus. The identification and limitations of use are addressed in ANSI A10.3-2013.

PATMI colour codes, power levels and definition of cartridges

Size	Colour code	Power level	Velocity of 350 grain slug		Calculated energy (joules)		
			ft./sec.	[m/sec.]	minimum	average	maximum
6.8 / 11 [Cal. 27 short]	Gray	1	370 ± 45	[113 ± 13.7]	111	144	182
	Brown	2	420 ± 45	[128 ± 13.7]	148	186	228
	Green	3	480 ± 45	[146 ± 13.7]	200	243	291
	Yellow	4	560 ± 45	[171 ± 13.7]	280	331	386
	Red	5	610 ± 45	[186 ± 13.7]	337	392	452
	Purple / black	6	660 ± 45	[201 ± 13.7]	399	459	524
6.8 / 18 [Cal. 27 long]	Green	3	550 ± 45	[168 ± 13.7]	269	319	373
	Yellow	4	630 ± 45	[192 ± 13.7]	361	419	480
	Blue	4.5	725 ± 45	[221 ± 13.7]	488	554	625
	Red	5	770 ± 45	[235 ± 13.7]	554	625	700
	Purple / black	6	870 ± 45	[265 ± 13.7]	718	798	883

In Europe, the European Standard EN 16264 specifies cartridge dimensions, colour codes and power levels, which are defined in terms of energy delivered

when a cartridge is fired in a standardized apparatus. EN 16264 specifies a 80 gram plunger.



EN 16264 colour codes, power levels and energy scale

Colour code	Power level	Energy scale
White/Brown	weakest	2
Green	weak	3
Yellow	medium	4
Blue	heavy	5
Red	very heavy	6
Black	heaviest	7

3. Health and safety

The safety of powder-actuated fastening systems can be clustered into two categories:

- Operator safety refers to safeguarding the operator and bystanders.
- Fastening safety refers to the adequacy of the in-place fastenings.

3.1 Operator safety

This refers to the measures taken to ensure that the tool does not endanger the operator and/or bystanders by firing at an overly high velocity, firing under the wrong conditions, generating excessive noise, or being used in the wrong way.

The piston principle

One of the main concerns about the use of powder-filled cartridges is the risks associated with a fastener missing the base material, or with a base material too weak to absorb the nail's energy. The piston principle ensures that the energy from the propellant in the cartridge is transferred to a piston which, in turn, drives the fastener. Because the piston is captive within the tool, it will absorb app. 95% of the driving energy in case a fastener misses the base material or the material is too soft for the fastener. As a consequence, the fastener will exit the tool at a speed that is far lower and less dangerous than that of tools which are not based on a piston.

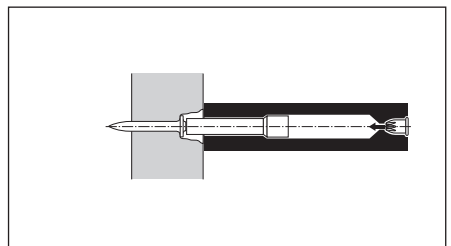
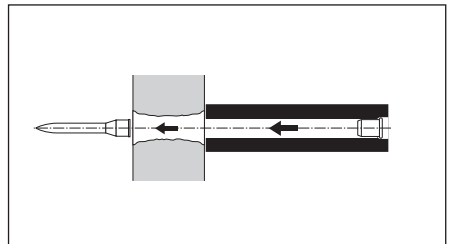

Tool safety mechanisms

To minimize the potential hazards during tool usage, Hilti has implemented the following safety mechanisms in all of its direct fastening tools.

Drop-firing safety

The drop firing safety mechanism prevents the tool from firing if dropped unintentionally. This mechanism is so designed that the tool, cocked or uncocked, will not fire when dropped at any angle onto a hard surface.



Trigger safety

The trigger in Hilti's DX- and GX-tools is uncoupled from the firing pin mechanism until the tool is fully compressed against the work surface. This mechanism ensures that pulling the trigger alone cannot cause the tool to fire.



Contact pressure safety

Hilti's direct fastening tools can only operate when pressed against the work surface. This requires a force of at least 50 N (5.1 kg, or 11.2 pounds). Tools with large base plates, such as DX 76 and GX 120, feature an additional surface contact pin that must also be pressed to allow the tool to operate.



Unintentional firing safety

Hilti's direct fastening tools will not operate unless first pressed against a work surface and then actioned using the trigger. This Hilti-designed feature ensures that no fastener exits a tool without the operator specifically intending it and focusing on the tool.



Powder cartridges and operator safety

EN16264 requires submitting each cartridge to overpressure tests in each of the tools for which it is intended. This ensures that the plastic collation strip is of adequate strength. EN16264 also defines the maximum amount of unburnt powder a cartridge may leave after combustion, as this residue may explode and cause injuries to the operators and to bystanders. Meeting this requirement is a prerequisite for CE conformity.

The Hilti cartridges come in packages that address all the norms discussed above. Each package displays the cartridge's energy level through a color dot, which tools it is associated with and approved for (known as "system approvals"), a marking on a US scale and another one on the European scale, in addition to the CE and CIP logos, as the following picture illustrates in the "black" portion of the package.



The identification and limitations of cartridge use in the U.S. are addressed in the ANSI/ASSE A10.3 norm.

Finally, it is also important that, whatever the cartridge, the operator follow the ventilation instructions provided in the Operating Instructions.

Gas cans and operator safety

Norms and standards relevant to gas cans include EN12205 and ISO 11118 as of 2018, which regulate the physical structure of gas cans. They also include the UN 1950 or UN 3150 norms, which define the conditions under which gas can shipping and distributing is considered safe. Regional regulations also apply depending on the operator's location: ADR/RID for Europe and ORM-D for the United States. All Hilti gas cans strictly abide by these norms.

To ensure that Hilti's gas cans are used in the appropriate conditions, each can features safety information in text and pictogram formats. In particular, it displays its expiry date, the maximum temperature it may be exposed to, its pressure level, and the "Extremely flammable" logo. The enclosing package also displays this information, in addition to recommended storage conditions. And the accompanying leaflet provides the complete list of potential hazards associated with the gas can.

GC 42 for use with the Hilti GX 3 tool.

For professional use only. Strictly for intended use only. Read the operating instructions and the safety regulations before use. Keep out of reach of children. **See edge of can for expiration date and lot number. Extremely flammable gas. Contains gas under pressure; may explode if heated. Contains Isobutane, Propane, Propane.** Pressurized container. Do not pierce or burn, even after use. Protect from sunlight. Do not expose to temperatures exceeding 50°C/122°F. Do not spray on an open flame or other ignition source. Keep away from heat/sparks/open flames/hot surfaces. — No smoking. Store the container in a well ventilated place. Recommended storage temperature: 5°C to 25°C (41°F to 77°F).

GC 42 Gasdose zur Verwendung im Gerät Hilti GX 3.

Nur für professionellen Gebrauch. Benutzung ausschliesslich gemäss Verwendungszweck. Vor der Inbetriebnahme Bedienungsanleitung und die Sicherheitsvorschriften lesen. Darf nicht in die Hände von Kindern gelangen. **Verfallsdatum und Abfüll-Los siehe Dosenrand. Extrem entzündbares Gas. Enthält Gas unter Druck; kann bei Erwärmung explodieren. Enthält: Isobutan, Propan, Propan.** Behälter steht unter Druck: Nicht durchstechen oder verbrennen, auch nicht nach der Verwendung. Vor Sonnenbestrahlung schützen und nicht Temperaturen von mehr als 50 °C/122°F aussetzen. Nicht gegen offene Flamme oder andere Zündquelle sprühen. Von Hitze/Funkentöffener Flammheissen Oberflächen fernhalten - Nicht rauchen. Nur in gut gelüfteten Bereichen verwenden. Behälter an einem gut gelüfteten Ort aufbewahren. Empfohlene Lagertemperatur 5°C bis 25°C (41°F bis 77°F).

GC 42 pour système Hilti GX 3.

Usage réservé aux professionnels, uniquement dans le cadre d'une utilisation normale. Lire le manuel d'utilisation et toutes les instructions de sécurité avant utilisation. Tenir hors de portée des enfants. **Date d'expiration sur la bordure de la cartouche. Gaz extrêmement inflammable. Contient un gaz sous pression; peut exploser sous l'effet de la chaleur. Contient: Isobutane, Propane, Propane.** Récipient sous pression: ne pas perforez, ni brûler, même après usage. Protéger du rayonnement solaire. Ne pas exposer à une température supérieure à 50 °C/122 °F. Ne pas vaporiser sur une flamme nue ou sur toute autre source d'ignition. Tenir à l'écart de la chaleur/des étincelles/des flammes nues/des surfaces chaudes. - Ne pas fumer. Stocker les cartouches dans un endroit bien ventilés. Température recommandée pour le stockage: 5°C à 25°C (41°F à 77°F).

81 ml 115 3e

(2.74 fl. oz.)

Made in Germany

www.hilti.com

Hilti Corporation, FL-9494 Schaan, Tel. ++423/234 21 11

Hilti = registered trademark of Hilti Corporation, Schaan, LI



Danger
Gefahr

2108613-10/2014



To enable the efficient tracking of any issue, the production lot number is also printed on each gas can and package.

The side illustration shows the typical graphical layout of a Hilti gas can.

The Hilti tools only operate with Hilti gas cans. This ensures that the tool receives gas in the right amount and composition, minimizing safety risks.

Noise-related operator safety

Hilti measures the noise its direct fastening tools emit as per the EN 15895 international standard to help operators and safety engineers plan the work in a way that minimizes risks. However, it should be noted that other ambient construction noises frequently compound with the tool's noise, which warrants additional precautions to protect operators. As a general rule, operators should always wear ear protection when operating the tools.

Vibration-related operator safety

Hilti direct fastening tools are not considered to produce vibrations as defined in international standards. However, as a precautionary measure, it is recommended to use the weakest possible cartridges to perform any given task, as well as to follow the instructions contained in the IFU.

Promoting operator safety through signaling and documentation

To ensure the safety of the operator and of bystanders, it is essential to follow the instructions contained in the Operating Instructions. Safety measures are also featured on pictograms inside the product carrying cases and on the consumables.



Hilti also covers safety measures as part of the operator training modules its local offices offer. The operators completing training receive a certificate of completion and/or an operator ID as required by local regulations. In some countries, the operators also get access to online material that serves as a refresher.

3.2 Fastening safety

The safety of a fastening point depends for a good part on the manufacturer correctly anticipating the conditions in which its tools and fasteners will be used on jobsites. This involves:

- 1) engineering and testing fastening systems within the framework of specific applications
- 2) ensuring that the finished products strictly match their technical specifications
- 3) ensuring that the fastening work on jobsites is performed as it is intended to be

Engineering and testing

Sources of information about the engineering and testing of a fastening system include the manufacturer's technical literature, official approvals and publications in technical journals. Hilti provides all of these for its products.

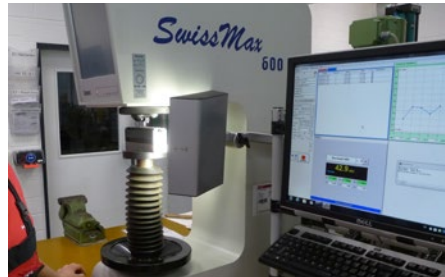

The use of a non-Hilti fastening system by an operator should be made contingent upon proof that the fastening system has been engineered and tested for the application the operator intends to perform.

Finished product quality

It is important that the manufacturer have a production quality control system. This is necessary for ISO 9001 certification. All Hilti production facilities are 9001 certified.

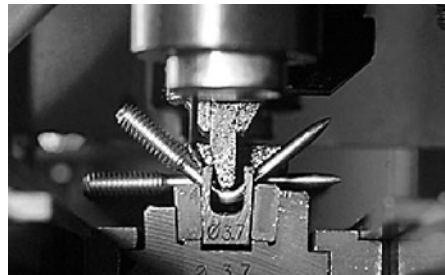

3.3 Quality of installation

Hilti contributes to the quality of the fastening work in the four following ways:

- 1) It provides application guidelines.
- 2) It provides technical advisory services.
- 3) Each box of nails designed and/or approved for specific applications comes with a plastic gauge enabling the operator to check if the nail's stand-off on the base material is within the acceptable margin
- 4) It manufactures devices enabling the tensile testing of fasteners. Threaded studs and certain decking fasteners can be tested in their final position on a jobsite. Other fasteners can be tested using a pull-over test specimen.



Checking the standoff of an ENP2 roof deck fastening with a plastic gauge



Pull-out test of an ENP fastening with a HAT28 tester and X-ENP adapter

As construction professionals demand fastening systems that are dependable without question, Hilti integrates functional reliability into the development, manufacturing, selling and servicing of its fastening systems. It does so paying particular attention to the reliability level required of each system, and the conditions in which it will be used.

During the development phase, Hilti engineers test the reliability of prototypes and system components regularly. In the plant, quality controls take place throughout the manufacturing process to ensure that the products are produced according to specifications.

When the first pilot production lots are delivered, contractors test them on jobsites. Adequate performance by the pilot production lots ensures that the products will be of good quality when mass-produced.

Hilti's sales staff gets trained to be in a position to advise customers on which system to use for their application, demonstrate how to use tools, and warn them about potential hazards.

Finally, Hilti's highly skilled tool repair and maintenance staff ensures that the fastening system functions optimally over the long run.



4. Corrosion

For decades, Hilti is concerned about corrosion of fastening systems and has gained a lot of experience in this area based on laboratory- and field tests. Extensive testing and research are conducted in test facilities of Hilti Corporate Research department, located around the world in different climate zones. Hilti strives to provide the best possible

support to customers for selecting the right product for safe and reliable fastening solutions.

This chapter gives an overview of corrosion protection solutions for Hilti Direct Fastening elements. More details on corrosion are described in the Hilti corrosion brochure „Corrosion handbook 2015“.

4.1 Corrosion protection of direct fastening systems

Carbon steel fasteners are subject to corrosion (red rust) when exposed to humidity.

Zinc is the coating most commonly applied on fasteners. Humidity attacks it before it attacks the carbon steel core. Thanks to Zinc's electro-chemical properties, this produces white rust on the coating but delays the formation of red rust on the core material.

Zinc has different removal rates depending on the surrounding environment.

The lifetime of zinc-based protection against corrosion is a function of two parameters: the environment's aggressiveness and the zinc's thickness. Depending on the degree of anti-corrosion protection required, additional layers of Zinc can be applied through passivation or organic topcoat.

Different variants of coating systems can be used to prevent fasteners from rusting. They are described in the following paragraphs.

Galvanic zinc coating:

This type of coating is generally suitable for environments with no corrosive potential. It is typically applied via an electrochemical process. Thicknesses up to 20 microns are possible, including passivation layer.

Hot dip galvanizing (HDG):

HDG is applied by dipping the parts to be protected against corrosion in a liquid zinc bath. The coating thickness can reach up to 80-100 microns, offering additional protection compared to galvanic zinc.

Duplex coating:

An alternative to hot dip galvanizing is duplex coating, i.e. the combination of a galvanic zinc layer with an supplemental reactive sealer the zinc in a first period. The equivalence in the protection offered by duplex coating and by HDG has been demonstrated on numerous occasions at Hilti test facilities around the world as well as at independent external labs. Duplex coating is applied to many Hilti grating fasteners, X-FCM-M.

Mechanical zinc plating:

Another alternative to hot dip galvanizing is mechanical plating. In this process, the zinc layer is built from zinc powder that is mechanically pressed onto the surface of the parts to protect. The equivalence in the protection offered by mechanical zinc plating and by HDG has been demonstrated on numerous occasions at Hilti test facilities around the world as well as at independent external labs.

Mechanical plating is applied on some Hilti nails and pins used in direct fastening.

Hydrogen embrittlement:

Hydrogen embrittlement is a specific corrosion phenomenon of zinc plated DX fastening elements, which will occur if three different conditions are present simultaneously:

- High strength carbon steel (>1000 MPa)
- Presence of hydrogen
- Tensile stresses

The combination of these three parameters leads to a decrease in the material's ductility, which may cause a sudden fastener failure even under very low static load.

The strength of fasteners is a function of its design and of the acceptable load in each application. Therefore, it is important to control the presence of hydrogen in the fasteners to prevent embrittlement from occurring. There are two main sources of hydrogen for zinc plated fasteners:

- The production process (primary hydrogen embrittlement): Hilti's power actuated fasteners are thoroughly tested and controlled during the production process to prevent primary hydrogen embrittlement.
- The corrosion process in the application (secondary hydrogen embrittlement): When zinc plated, high-strength fasteners are used in wet atmosphere, hydrogen is formed by the chemical reaction of zinc and water and diffuses into the material. To avoid secondary hydrogen embrittlement during the service life of a fastener, it is essential to follow the recommended application conditions provided for each nail in Hilti technical documents.

Stainless steel

Stainless steel comes in many different types, each of which has different corrosion resistance properties. A stainless steel material used in a wrong environment can lead to pitting corrosion and, subsequently, sudden fastener failure. In such a situation, predicting a fastener's lifetime is not possible.

Hilti power actuated fasteners are manufactured using CR500 and 1.4462 material, similar to A4 (AISI grade 316), which offers high performance in a wide range of applications.

For higher corrosion requirements, fasteners made out of HCR (1.4529) material can be provided. The HCR (High Corrosion Resistance) material can be used in swimming pools and in road tunnels, where the performance of A4 material is not sufficient.

Stainless steel with pitting corrosion, e.g.
A4 material used in a road tunnel

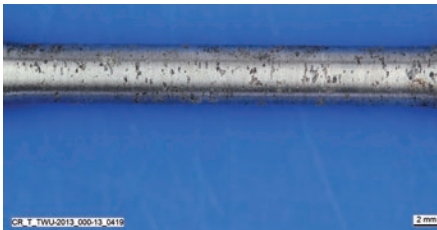

Suitable stainless steel used, e.g. HCR
material used in a road tunnel



4.2 Fastener selection

Following table (next page) gives a general guideline of commonly-accepted applications in typical atmospheric environments. Suitability of fastening systems for a specific application can be significantly affected by localized conditions, including but not limited to:

- Elevated temperatures and humidity
- High levels of airborne pollutants
- Direct contact with corrosive products, commonly found in chemically-treated wood, waste water or salt water, concrete additives, cleaning agents, etc.

- Non-atmospheric corrosion like e.g. direct contact to soil, stagnant water
- Cyclical wetting
- Electrical current
- Contact with dissimilar metals
- Physical damage or wear

Environmental conditions		Fastened part	Carbon steel		Stainless steel		
			Galv. zinc coating	Duplex coating	CR500 or 1.4462 (A4, AISI 316)	HCR 1.4529	
			Fastener X-ENP ¹⁾ , X-U X-FCM-M X-BT, X-CR On demand X-GHP				
		Dry indoor	steel (zinc coated, painted), aluminum, stainless steel, wood	■	■	■	■
		Indoor with temporary condensation	steel (zinc coated, painted), aluminum, stainless steel, wood	Consult experts for exceptions	■	■	■
		Outdoor, non-safety relevant ²⁾	steel (zinc coated, painted), aluminum, wood	■	■	■	■
		Outdoor, rural or urban environment with low pollution	steel (zinc coated, painted)	—	■	■	■
			aluminum, stainless steel	—	Consult experts for exceptions	■	■
		Outdoor, rural or urban environment with moderate concentration of pollutants and/or salt from sea water	steel (zinc coated, painted)	—	Consult experts for exceptions	■	■
			aluminum, stainless steel	—	Consult experts for exceptions	■	■
		Coastal areas	steel (zinc coated, painted), aluminum, wood	—	—	■	■
	0-1 km	Outdoor, areas with heavy industrial pollution	steel (zinc coated, painted), aluminum, wood	—	—	■	■
	0-10 m	Close distance to streets	steel (zinc coated, painted), aluminum, wood	—	—	■	■
	Special applications	Road tunnels, indoor swimming pools, special applications in chemical industry	steel (zinc coated, painted), aluminum, wood	—	—	Consult experts for exceptions	■

■ = expected lifetime of power actuated fasteners made from this material is typically satisfactory in the specified environment based on the typically expected lifetime of a building. The assumed service life in ETA approvals for power actuated fasteners is 25 years.

— = fasteners made from this material are not suitable in the specified environment. Exceptions need a specific assessment.













1) Outdoor exposure for up to 6 months during construction is permissible for high-strength electro-galvanized siding and decking fasteners such as the X-ENP (see instructions for use for details)

2) The reference to “non-safety relevant” is intended to distinguish applications where failure of the attachment will not create any potential safety risks or significant damage.

Remarks:

- The ultimate decision on the required corrosion protection must be made by the customer. Hilti accepts no responsibility regarding the suitability of a product for a specific application, even if informed of the applications conditions.
- This table is based on an average service life for typical applications.
- For metallic coating e.g. zinc layer systems the end of life time is the point where red rust is visible over a large percentage of the product and widespread structural deterioration can occur – the initial onset of rust will occur much sooner
- National or international codes, standards or regulations, customer and/or industry specific guidelines must be independently evaluated.
- These guidelines apply to atmospheric corrosion only. Other types of corrosion, such as crevice corrosion or stress corrosion cracking must be independently evaluated.

A typical service life of Hilti GX-WF nails in wood - wood connections is shown below:

Service Classes in accordance with EN 1995 (Eurocode 5):		Service Class 1	Service Class 1,2	Service Class 1,2,3			
Type of Corrosion Protection for Hilti GX-WF wood nails (d ≤ 4mm):		No Corrosion Protection	Zinc coated	HDG	A2 ¹⁾	A4	
		Dry indoor	20 to 50 years	up to 50 years	up to 100 years	■	■
		Indoor environments with temporary condensation	—	10 to 50 years	60 to 100 years	■	■
		Outdoor with low pollution	—	5 to 20 years	40 to 100 years	■	■
		Outdoor with moderate concentration of pollutants	—	2 to 10 years	20 to 40 years	■	■
		Coastal areas	—	up to 5 years	10 to 30 years	—	■
		Outdoor, areas with heavy industrial pollution	—	up to 5 years	10 to 30 years	—	■
		Close distance to streets	—	—	—	—	■
	Special applications	Special applications	Consult experts for exceptions				

The table above provides typically assumed service life estimations based on corrosion considerations. Other factors determining the service life of fasteners must be evaluated separately.

■ = expected lifetime of nails made from this material is typically satisfactory in the specified environment based on the typically expected lifetime of a building.

— = nails made from this material are not suitable for the environment or the typical lifetime of a building is not achieved.

1) For nails made of A2 material, discoloration of nail heads can occur before the service life in the table above is reached. To avoid this, use A4 material.

Remarks:

- The use of certain wood species including, but not limited to, Oak, Douglas-fir or Western Red Cedar, require the use of stainless steel nails, independent of Service Class and environmental conditions.
- The use of certain wood treatments including, but not limited to, fire retardants or preservatives can change the chemical composition of the wood and may require the use of stainless steel nails, independent of Service Class and environmental conditions.
- The evaluation of corrosive environmental conditions depends on many factors and lies within the responsibility of the customer. The planned service life of the buildings or structures can be considered according to local or national building regulations and Eurocode (EN 1990)
- The table does not contain recommendations and Hilti does not assume liability for fastener selection based on its content.
- For the typical service life, it is assumed that the nails are selected, designed, installed and otherwise treated in accordance with Hilti's published literature.
- Local building regulations and trade rules may differ from the table above. The local jurisdiction always needs to be followed.
- Wood to steel connections may require a minimum corrosion protection, independent of the environmental conditions.

5. Steel base material

5.1 Anchoring mechanisms

The following four mechanisms cause a fastener to hold when driven into steel:

- clamping
- keying
- fusing (welding)
- soldering

These mechanisms have been identified and studied by analyzing pull-out test data and by microscopic examination of fastening cross-sections.

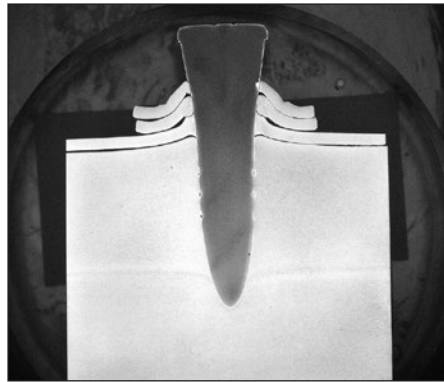

Clamping

As a fastener is driven, the steel is displaced radially and towards both the entry and opposite surfaces. This results in residual pressure on the surface of the nail, which leads to friction or clamping. Clamping is the primary anchoring mechanism of through-penetrating fasteners. This is indicated by the fact that when through-penetrating fasteners are extracted, the pull-out force decreases only slowly over several millimeters of displacement.

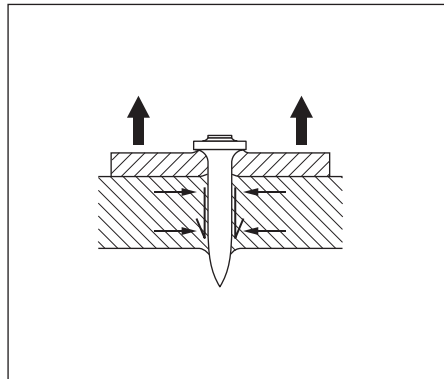

Keying

The keying mechanism is possible when the fastener is knurled, that is, it has fine grooves along the shank in which zinc and particles of base steel accumulate during the driving process. Microscopic examination of cross sections has shown that the grooves are not completely filled. Keying is an especially important anchoring mechanism for fasteners that do not penetrate right through the base material.

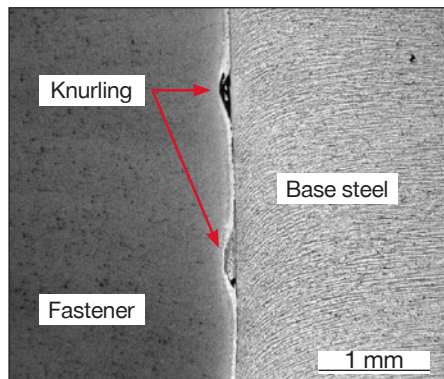

Fusing (welding)

Complete fusing of the fastener with the base steel is indicated by portions of base material clinging to the extracted fastener. Fusing or welding is observed mostly at the point of a fastener where the temperature during driving can be expected to be the highest.

For fasteners that do not through-penetrate, this is an important anchoring mechanism. It can be relied upon only if the fastener point is manufactured without cracks and with an appropriate geometry. The thermo pulling process is ideal for achieving an optimized geometry. Control of all steps in the production process is necessary to avoid

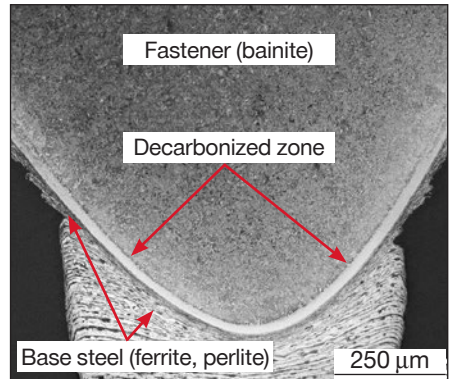

cracks in the point.

Soldering

In the zone further from the point, there is a prominent zinc layer separating the fastener from the base steel. This zinc, soldered to the base steel, also makes a contribution to the pull-out resistance of the fastener.

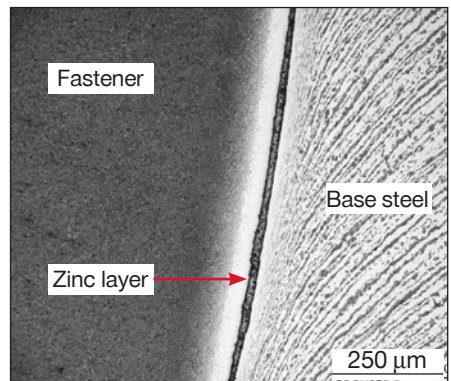

Blunt-tipped fastener X-BT family

The X-BT fastener with a shank diameter of 4.5 mm is driven in a pre-drilled 4.0 mm diameter hole. This leads to displacement of the base material. Part of the base steel is punched down into the pre-drilled hole, generating high temperatures and causing friction welding. Due to elasticity of the base steel, additional clamping effects are also superposed.

Displaced base material can be clearly seen in the photograph. Base material adhering to the fastener shank indicates a welding effect.



5.2 Factors influencing pull-out resistance

Powder-actuated fastening systems must be designed and manufactured to ensure that pull-out resistance will be adequate for the applications intended. Through understanding of the anchoring mechanisms, experience and testing, factors that influence pull-out strength have been identified. Some of these factors are:

- Depth of penetration in the base material
- Surface characteristics of the fastener
- Coatings on the steel base material
- Driving velocity
- Diameter of the fastener shank

Knowledge of the influencing factors is vital to the design of fastening systems and is useful for operators in understanding the various application guidelines and restrictions that apply to a fastening system. Some of the influencing factors are discussed in the following section.

Depth of penetration in the base material

The depth of penetration of fasteners in steel is taken as the distance that the point travels below the surface of the base steel, independent of the steel thickness. In other words the depth of penetration h_{ET} can be greater than, equal to or less than the steel thickness.

Resistance to pull-out increases with increasing depth of penetration. This is also true for through-penetrating fasteners where h_{ET} is greater than the steel thickness. The design of a powder-actuated fastener has to take into account the depth of penetration necessary to achieve the pull-out resistance required for the application. Application guidelines published for any fastener include the required nail head stand-off h_{NVS} , which corresponds to the penetration depth.

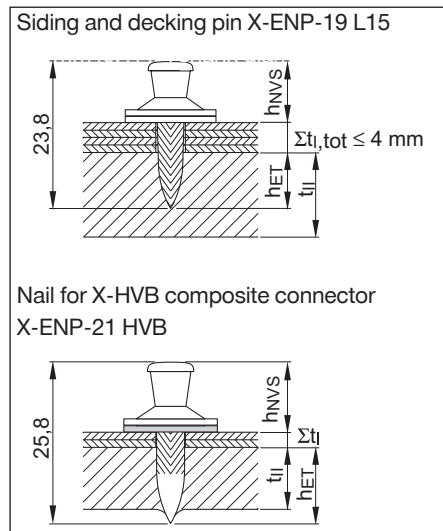

Guide values for the depth of penetration of specific fastener types are as follows:

Galvanized fastener with knurled shank:	$h_{ET} = 12$ to 18 mm	(shank diameter 4.5 mm)
	$h_{ET} = 10$ to 14 mm	(shank diameter 3.7 mm)
Galvanized fastener with knurled tip:	$h_{ET} = 9$ to 13 mm	(shank diameter 4.5 mm)
Galvanized fastener with smooth shank:	$h_{ET} = 15$ to 25 mm	
Stainless steel fastener with smooth shank:	$h_{ET} = 9$ to 14 mm	
Blunt-ended fasteners:	$h_{ET} = 4$ to 5 mm	

The effect of penetration depth on pull-out strength can be demonstrated in experiments in which the driving energy is varied so as to produce varying penetration. The results of a test of this kind are summarized below. The application recommendations for fasteners are based on tests like these and they clearly show the importance of carrying out the fastening installation in accordance with the recommendations of the manufacturer.

Steel: $t_{II} = 20$ mm (0.787")
 $f_U = 630$ N/mm² (91.000 psi)
 Tool: DX 76 / DX 76PTR, DX 860-ENP and DX 9-ENP
 Fastener: X-ENP-19 L15

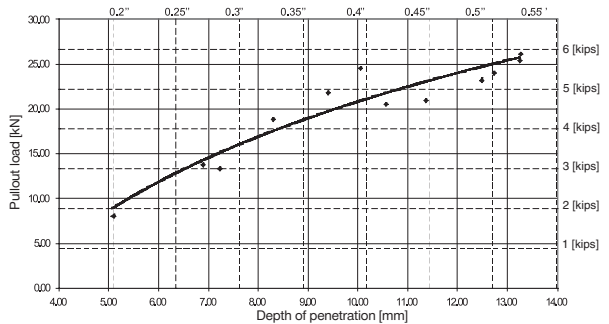
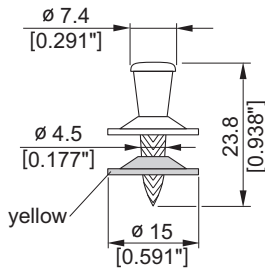

Knurling on the fastener shank

Fasteners for use in steel base material usually have knurling on the shank so as to improve the resistance to pull-out. The effect of the knurling was shown in a test with fasteners that had knurled and unknurled shanks, but were otherwise the same.

The benefit of knurling is clearly seen from the test results. With virtually the same penetration (actually 106%), the smooth-shank fastener had only 68% of the pull-out strength of the knurled-shank type. Even with the penetration increased to 137%, the pull-out strength was still only 81% of that of the knurled-shank fastener. In this test, the steel thickness of 10 mm (0.394") allowed through penetration of the steel. If the steel is too thick for through penetration, the beneficial effect of knurling becomes even more pronounced.

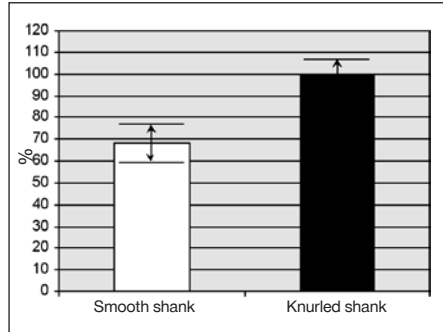

Zinc coating on the fastener shank

Zinc on a fastener shank appears to act as a lubricant that reduces its resistance to penetration into steel. Reduced pull-out strength is the result, because the lower resistance means less heat is generated, thus reducing the welding effect between the shank and the base steel. This was shown in an experiment with fasteners that were identical except for the thickness of zinc coating.

Steel base material: $t_{II} = 20 \text{ mm [0.787"]}$,

$f_u = 440 \text{ MPa [63,817 psi]}$

Zinc thickness in mm	Average penetration		Average ultimate pull-out load		Variation CV %
	h_{ET} mm / [in.]	%	$N_{u,m}$ kN / [kip]	%	
ca. 10	12.12 [0.477]	100	8.53 / [1.918]	67	25.6
2-5	11.86 [0.470]	98	12.82 / [2.882]	100	9.3

Although driving the fastener through sheet metal, as is the case when fastening siding and decking, reduces the negative effect of zinc coating on pull-out strength, the reason for tightly controlling the galvanization process is clear.

Surface of the steel base material

Corrosion protection of structural steel is often achieved by hot-dip galvanizing. Tests have shown that if the fastener penetrates right through the steel, the galvanizing has no significant effect on pull-out strength. In the case of fasteners that do not through-penetrate, pull-out strength is reduced by about 25%. The summary of results from one test is shown below to illustrate these effects.

Average ultimate pull-out loads

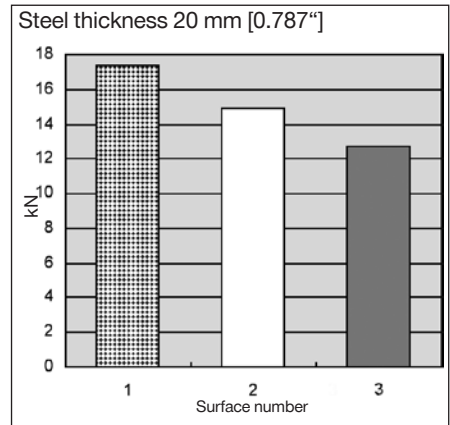
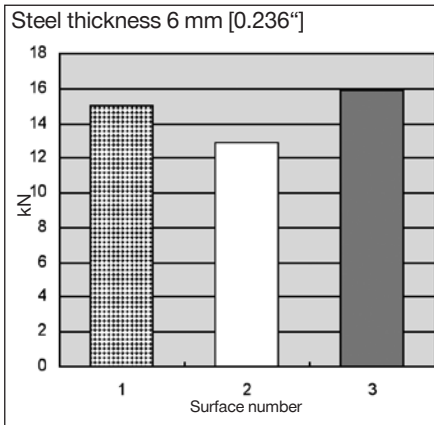

Ultimate tensile strength of steel :
Surface of the steel :

$f_u = 430 \text{ MPa}$ [62,366 psi]
1. Rough with some slag and rust (reference)
2. Sandblasted
3. Pickled + hot-dip galvanized (min. 60 μm zinc)

Several important observations can be made based on these results:

- Pull-out loads in 6 mm ($1/4''$) steel base material are much less affected by the surface condition of the steel than they are in 20 mm ($3/4''$) steel. The reason is that the main anchoring mechanism of through-penetration fastenings is clamping, which is not affected by the surface condition of the steel.
- Hot-dip galvanizing appears to reduce the pull-out strength of non-through-penetrating fastenings by nearly 30%. Note, however, that even with hot-dip galvanizing, the pull-out strength was still 12.5 kN (2.8 kips).
- The negative effect of hot-dip galvanizing is explained by the tendency of zinc on the fastener to act as a lubricant that reduces heat generation during driving. This in turn reduces the tendency of the fastener point to fuse to the base steel. Zinc from the coating on the base steel apparently becomes attached to the fastener as it enters the base steel.

For applications where tensile strength of the fastening is critical and the steel has a heavy coating, the fastening system can be qualified by carrying out pull-out tests on site. If pull-out strength is not adequate, depth of penetration can be increased to improve the situation.

Tensile stress in the steel

The integrity of a powder-actuated fastening is dependent on a relatively smooth pin remaining anchored in structural steel. A large amount of test data, technical assessments, approvals and practical experience with powder-actuated fastenings is available to support use of powder-actuated fastening. Performance of fasteners anchored in the steel under tension was investigated by driving fasteners into unstressed steel plates and extracting them with the plates stressed in tension. The steel plates measured 6x80x455 mm [0.236" · 3.15" · 17.9"] and possessed two different yield stresses - 328.6 MPa [47.7 ksi] and 411.7 MPa [59.7 ksi].

By expressing the steel stress in terms of % of actual yield, it was possible to combine the data for both steel grades and obtain a reasonable curve fit.

Of significance to the designer is the expected decrease in pull-out strength of the fastener at a typical maximum allowable design stress of 60 to 70 % of yield. At this stress, the pull-out strength reduction is less than 15%. The absolute value in the experiment was still greater than 2 tons.

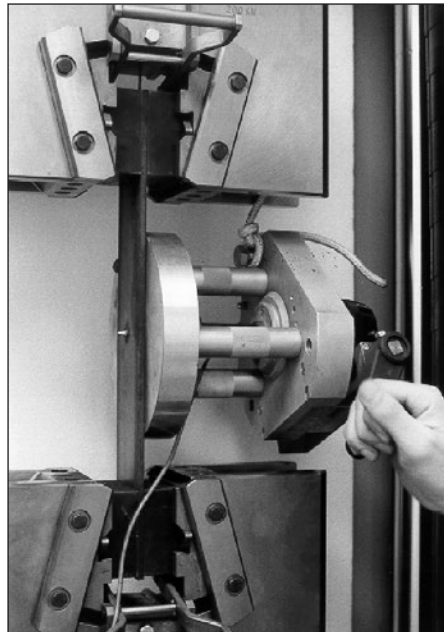
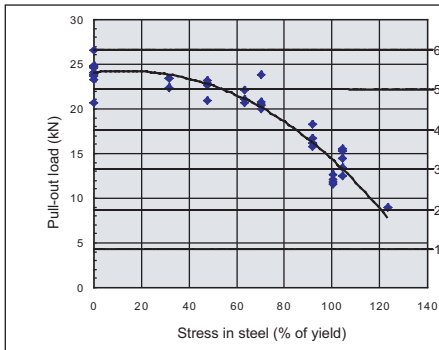

Compressive stress in the steel

Compressive stress in the base steel has no influence on the pull-out strength of the fastener. This was demonstrated by placing fasteners in unstressed 15 mm [0.59"] thick steel plates having a yield strength of 259.3 MPa [37.6 ksi] and extracting them while the plates were compressed in a testing machine.

The minimal variation in pull-out load is simply random variation experienced in testing.

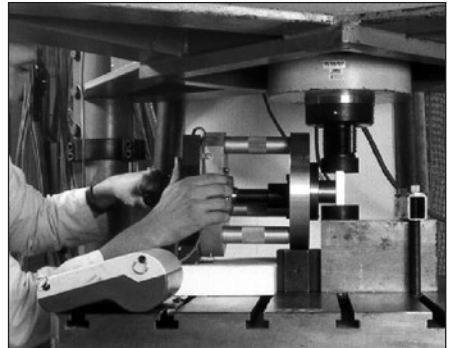
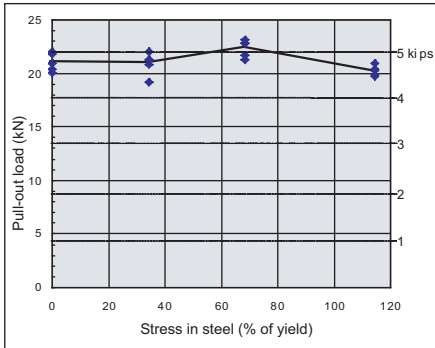

5.3 Suitability of the steel for fastening

There are three main factors determining the suitability of a construction grade steel member for DX fastening:

- Steel thickness
- Ultimate tensile strength
- Flexibility of the base steel member

5.4 Application limit diagrams

The application limit of a fastening system is a term applied to a combination of the maximum thickness t_{II} and ultimate tensile strength f_u of steel in which fastenings can be made. There are two general types of application limit diagrams:

- Short fasteners (e.g. siding and decking nails and threaded studs)
- Long fasteners (e.g. nails used to fasten wood to steel)

The application limit line for a short fastener is a plot of steel thickness versus ultimate tensile strength. In situations represented by steel thickness / ultimate tensile strength combinations above and to the right of the line, some of the fasteners may shear off during driving. The failure surface will be roughly at a 45° angle to the shank length.

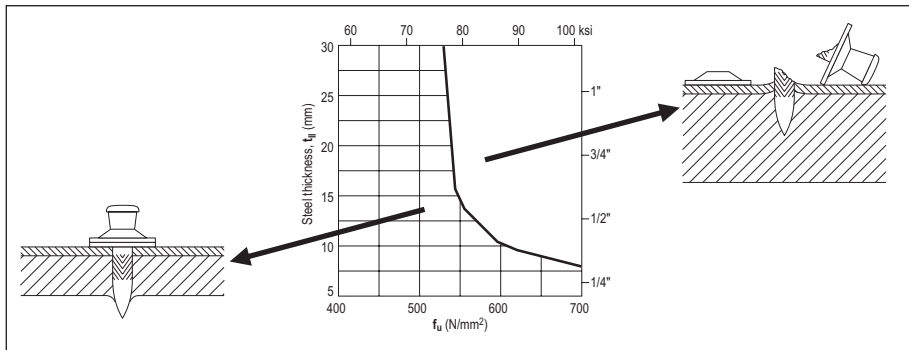

The application limit lines for long nails used to fasten wood to steel are plots of nail shank length L_s versus steel thickness t_{II} . Each line is valid only for one ultimate tensile strength of steel f_u . Attempts at working to the right of the limit line result in buckled nail shanks.

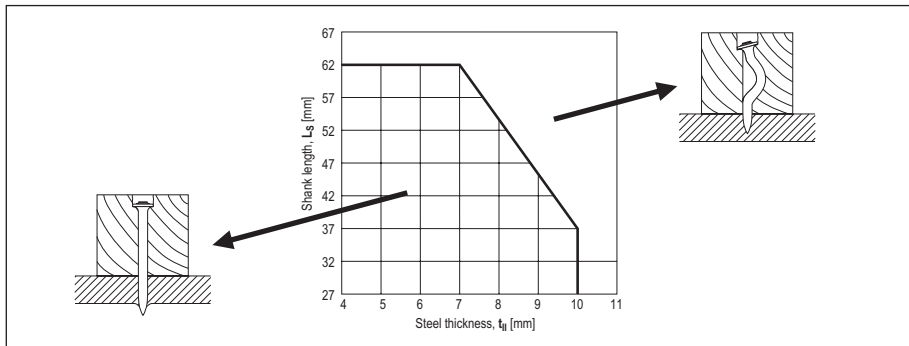

5.5 Thin steel base material

In the context of powder-actuated fastening, steel is considered thin when flange deformation during driving dominates fastener design. When the steel flange is thinner than about 6 mm [0.25"], flange deformation makes use of fasteners with a 4.5 mm [0.177"] shank diameter more difficult and switching to a 3.7 mm [0.145"] shank fastener leads to better results. Use of fasteners with tapered shanks and energy-absorbing washers improves performance and reliability.

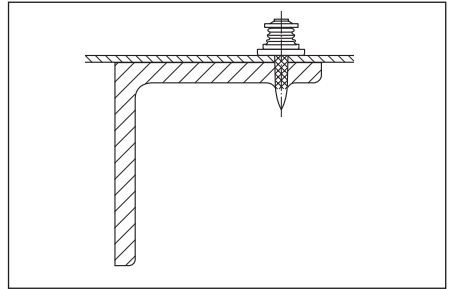
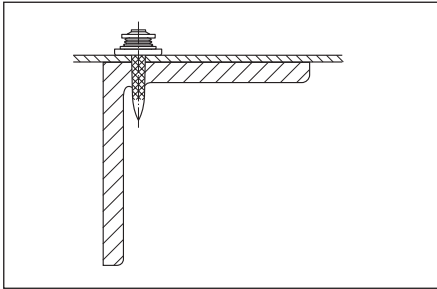

A fastener can penetrate into steel only when the steel (flange) develops a resistance greater than the force required for penetration. This implies the use of energy in excess of that required for penetrating into the steel. In fact, if the driving energy remains constant, fasteners placed closest to the web will be driven deepest. All siding and decking fasteners should have a mechanism to clamp the sheets down tightly over the entire range of allowable standoffs. This is especially critical for fasteners used for fastening to thin steel.

Obviously, under shear loading, failure of the base material is more likely with thin steel than with thick steel. When approving fastening systems for a project, it is important to consider whether the system has actually been tested with thin base steel or not.

Hilti's general recommendation for thin base steel fasteners is to place the fastenings within $b_x = 8 \cdot t_{fl}$ of the web.

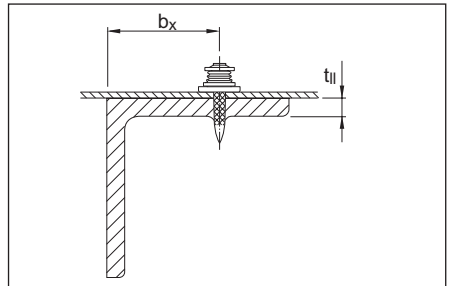
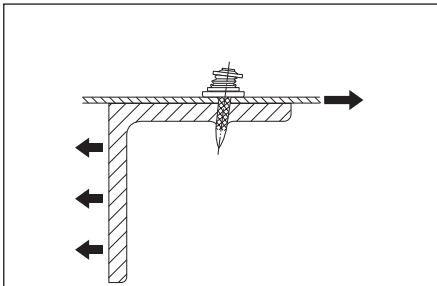

5.6 Types of load and modes of failure

5.6.1 Shear loads

The shear loads acting on siding and decking fasteners come from:

- Diaphragm action of the fastened sheets
- Forces of constraint (for example due to temperature changes)
- Self-weight of siding material

Testing

Shear testing of siding and decking fastenings is done using specimens made up of a strip of sheet metal fastened to a steel plate. Suitable, non-slip fixtures have to be used at either end. In some cases specimens are bent up at the sides to hinder eccentricity.

Failure of the fastened material

The load-deformation curves of shear tests with powder-actuated fasteners show a nearly ideal behavior. After an initial elastic phase during which the clamping force of the washers against the sheet metal is overcome, the sheet metal reaches its yield stress in an area where the fastener bears against it. Then the fastener shank cuts through the sheet metal until the end of the sheet is reached. The large area under the load-deformation curve represents energy absorbed, and this is what makes the fastening method ideal for diaphragms.

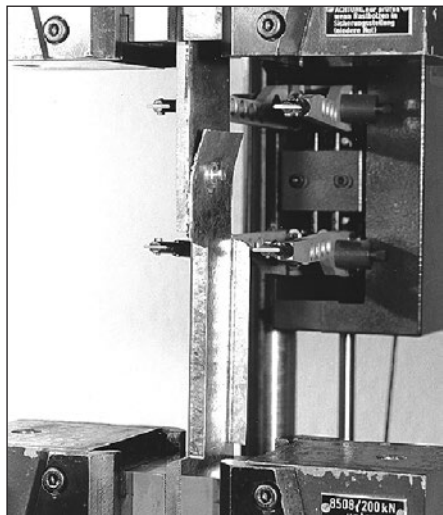

Failure of the base steel

If the thickness of the fastened sheet metal is large compared to the base steel thickness, bearing failure of the base material is a possible mode of failure.

Pull-out from the base steel

The unavoidable eccentricity in the shear test specimen leads to a tensile load component on the fastener. Thick fastened material and thin base material is also involved in this mode of failure. This failure mode is generally not governing for base material thickness of $t_{II} > 6$ mm.

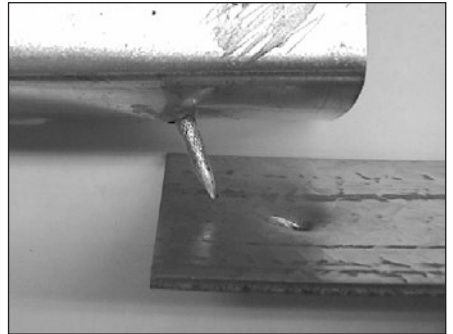

Fracture of the fastener

About 20 kN (4.5 kips) of force is required to shear the $\text{Ø} 4.5$ mm (0.177") shank of an X-ENP-19 L15 fastener. With about 2.5 mm (12 gauge) thick steel sheet as fastened material, a force of this magnitude could be possible. The force needed to break a $\text{Ø} 3.7$ mm (0.145") shank of an X-ENP2K-20 L15 fastener is about 13 kN (2.9 kips). This force can be generated with 1.5 mm (16 gauge) sheet steel. In practice, this failure mode is likely only where expansion joints are not provided to relieve forces of constraint from temperature differences.

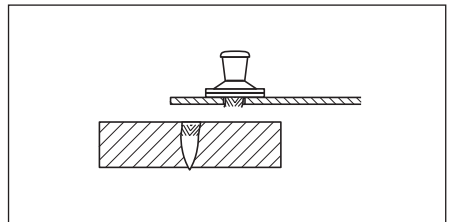

5.6.2 Tensile loads

The most common source of tensile loading on siding and decking fasteners comes from wind suction acting on the roof or wall cladding. In diaphragms, fasteners can be subject to tensile loads in situations where the combination of geometry and thickness of decking fastened leads to prying. In designs with very stiff decking and wide beams or unbalanced spans, prying can also be caused by concentrated loads.

Testing

Tensile testing of siding and decking fastenings is carried out using specimens made up of a trapezoidal-shaped piece of sheet metal fastened to a steel plate. Suitable, vice-like fixtures are used to grip the specimen. This is often referred to as a pull-over test because the common failure mode is the sheet pulling over the washers or the head of the fastener. If the sheet thickness fastened is increased so that pull-over does not govern, pull-out will be the failure mode.

Some fasteners like the Hilti X-ENP have a head that can be gripped and pulled out by a suitable fixture. With these fasteners, a pull-out test can still be done even if pull-over is the original mode of failure. This fastener type has the further advantage of allowing in-place fasteners on a jobsite to be tested.

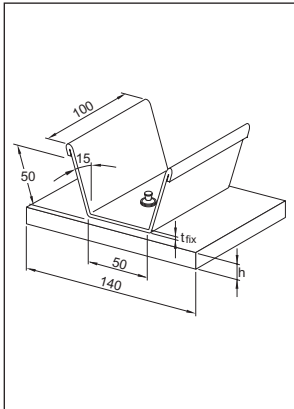

Pull-over test specimen

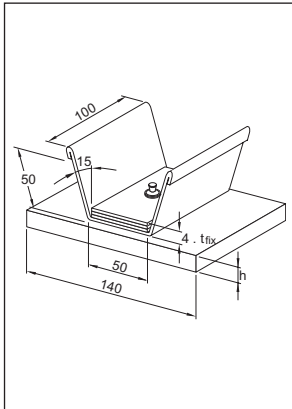

Pull-over test specimen with 3 extra layers to simulate end lap – side lap



Test setup

Sheet pull-over

In this failure mode, the sheet tears and is lifted up over the fastener head and washers. Depending on the sheet thickness and tensile strength, the washers may be bent up.

Washer pull-over

Another possible failure mode is that of the washers being pulled up over the head of the nail. Obviously, this happens when the sheet is somewhat stronger and /or thicker than when sheet pull-over occurs. This failure mode is also heavily dependent on fastener design.

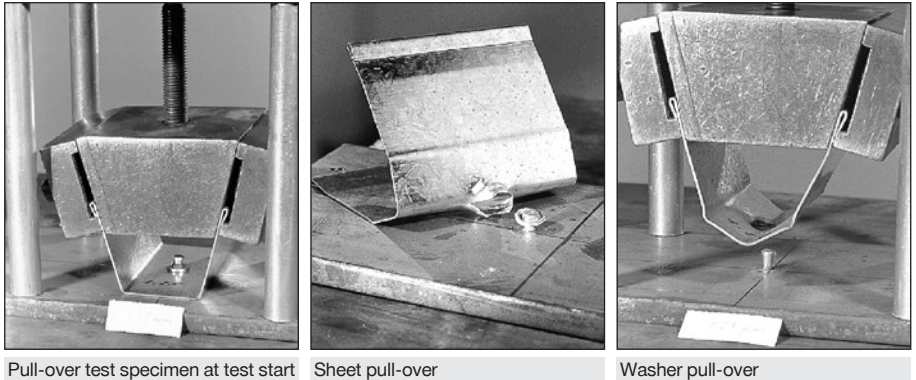

Pull-out from the base steel

As sheet thickness and number of layers is increased, this failure mode becomes more likely. For a properly driven **X-ENP-19 L15** pull-out from the base steel is not a likely mode of failure. The head and washer design of the **HSN 24** or **X-ENP2K-20 L15** fasteners can allow this failure mode, especially with multiple layers of sheets.

Fracture of the fastener

A force of more than 30 kN [6.7 kips] is required to break the $\varnothing 4.5$ mm [0.177"] shank of an **X-ENP-19 L15** fastener and, even if sheet or washer pull-over does not govern, pull-out strengths of this magnitude are not very common. This mode of failure will therefore hardly ever occur with these heavy-duty fasteners. The $\varnothing 3.7$ mm [0.145"] shank of an **X-HSN 24** or **X-ENP2K-20 L15** fastener may break at about 20 kN [4.5 kips] tension. Since these smaller fasteners will pull out at a force of 8 to 15 kN [1.8–3.3 kips], fractures due to tensile loads are rare. If fractured fasteners of this type are found on a jobsite, the most likely cause is that the application limit has been exceeded (the base steel is too hard and/or too thick for the pin).

Cyclic loading

Siding and decking nails used in wall and roof construction are subject to cyclic loading from wind suction. Cyclic load testing is carried out to determine characteristic resistance and allowable (recommended) loads. The requirements of the European Technical Assessment ETA prepared by DIBt (Deutsches Institut für Bautechnik) govern the design-relevant number of load repetitions (5,000) and the necessary safety factors. Notes in this regard are found on the corresponding product data sheets.

If the fastener will be subjected to a large number of load repetitions and fatigue, we recommend carrying out a design check according to the requirements of Eurocode 3 (or similar

code). Eurocode 3 gives the characteristic fatigue resistance and safety concept for steel construction. To carry out the check according to Eurocode 3 it is necessary to have a statistical analysis of test data obtained under the application conditions. Except for siding and decking fasteners, the applicable product data sheets limit the validity of recommended loads to predominantly static loading. If a design analysis has to be carried out for true fatigue loading, test data can be obtained from Hilti. Examples of such data are shown below.

**X-EM8-15-14
(standard zinc-plated fastener)**

The X-EM8-15-14 has a shank diameter of 4.5 mm and a hardness of HRC 55.5 ($f_u = 2,000$ MPa). The ΔF -N diagram shows the load range ΔF for a lower load of 0.05 kN. The individual test results are displayed as points and the curves show average and characteristic (95% survival probability) values. The failure mode was shank fracture or fracture in the M8 threading.

The recommended load for predominantly static loading is 2.4 kN. Comparing this value to the ΔF -N diagram will lead to the conclusion that X-EM8-15-14 fastenings designed for 2.4 kN static loading will survive a large number of load repetitions. The fastenings can be said to be robust, even when the actual loading turns out to be in part cyclic.

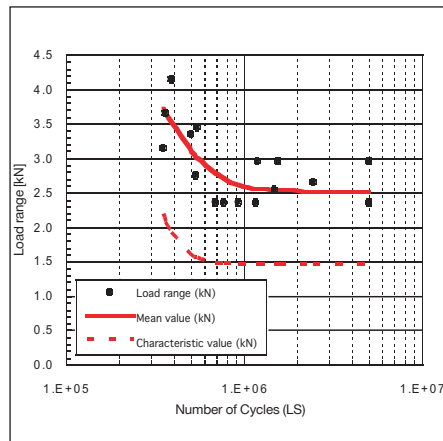

X-CRM8-15-12 (stainless steel fastener)

The X-CRM8-15-12 has a shank diameter of 4.0 mm and a minimum ultimate tensile strength of 1,850 MPa. The ΔF -N diagram shows the load range ΔF for a lower load of 0.05 kN. The individual test results are displayed as points. The failure mode was shank fracture or fracture just below the head of the stud.

The recommended load for predominantly static loading is 1.8 kN. Comparing this value to the ΔF -N diagram will lead to the conclusion that X-CRM8-15-12 fastenings designed for 1.8 kN static loading will survive a large number of load repetitions. The fastenings can be said to be robust, even when the actual loading turns out to be in part cyclic.

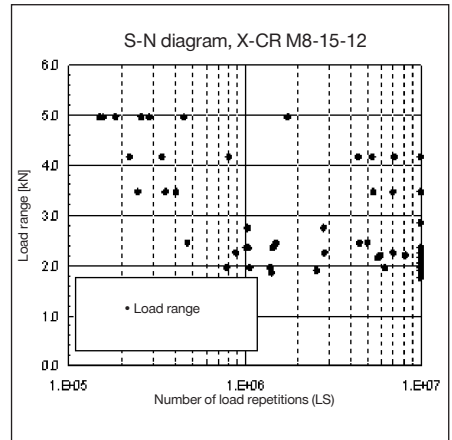
**Mode of failure under cyclic loading**

A major finding of cyclic loading tests is that the strength of a DX fastening subject to cyclic loading is not limited by failure of the anchorage. It is only when the number of cycles is very low – i.e. predominantly static loading – that nail pull-out is observed. The two schematic diagrams below show the relationship between failure mode and number of cycles. All tests show that the anchorage of DX fasteners in steel and in concrete is extremely robust with regard to resisting cyclic loading. Fasteners subject to a large number of load repetitions fracture in the shank, head or threading. A condition for obtaining this behaviour is that the fasteners are correctly driven. Fasteners that are not

driven deeply enough exhibit low pull-out strength and in a cyclic loading test may not necessarily fail by fracture.

Effect of number of cycles on failure mode DX fastener in steel (correctly placed)

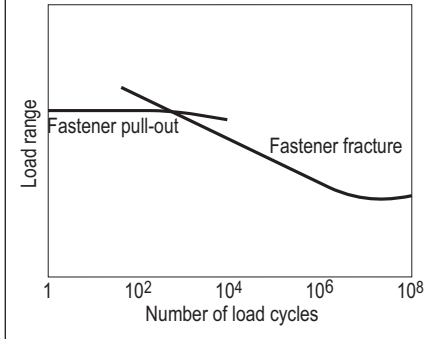

Effect of number of cycles on failure mode DX fastener in steel (incorrectly placed)

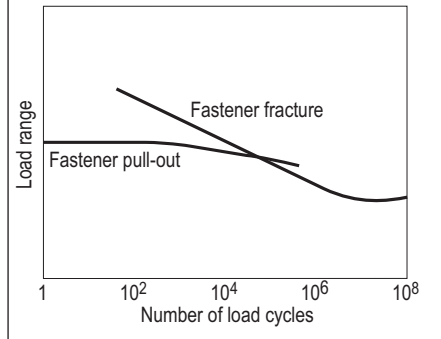

In older product information and data sheets, this basic suitability of DX fasteners for cyclic loading was emphasized by defining the recommended loads as cyclic recommended loads. At the time that this product information was assembled, a true safety concept for a strict check of DX fastenings subject to fatigue loading was not available. With Eurocode 3, this is today available. If a fatigue design analysis is carried out, it is important – as with static design – that adequate redundancy be provided.

Failure of the sheet

In cyclic load tests, failure of the steel sheet itself is common.

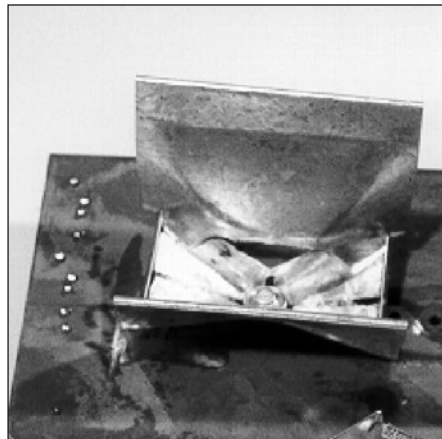

5.7 Effect of fasteners on structural steel

Driving powder-, gas-, or battery-actuated fasteners into a steel member does not remove steel from the cross-section, but rather displaces steel within the cross-section. It is therefore not surprising that tests like those described in following sections show that both drilled holes and screws, either self-drilling or self-tapping, reduce the strength of a cross-section more than powder-actuated fasteners.

The results of the tests can also be used to show that it is conservative to consider a powder-actuated fastener as a hole. This allows the effect of fasteners in a steel member subject to static loading to be taken into consideration.

Fatigue seldom needs to be considered in building design because the load changes are usually minor in frequency and magnitude. Full design wind and earthquake loading is so infrequent that consideration of fatigue is not required. However, fatigue may have to be considered in the design of crane runways, machinery supports, etc. The S-N curves resulting from fatigue tests of steel specimens with fasteners installed are also presented.

5.7.1 Effect on the stress-strain behaviour of structural steel

The effect that powder-actuated fasteners (PAF's) have on the stress-strain behaviour of structural steel was investigated in a systematic test programme using tensile test specimens containing PAF's, self-drilling screws and drilled holes. A control test was carried out using specimens without any holes or fasteners.

Series A:

- ASTM 607, grade 50
- Cross-section 3.42 x 74 mm [0.135 x 2.913"]
- X-EDNK22 powder-actuated fasteners, shank diameter 3.7 mm [0.145"]
- Drilled holes, diameter 3.7 mm [0.145"]
- Self-drilling screws, shank diameter 5.5 mm [0.216"]

Series B:

- S235 and S355 steel
- Cross-section 6 x 45 mm [0.236 x 1.772"]
- Powder-actuated fasteners, shank diameter 4.5 mm [0.177"]
- Drilled holes, diameter 4.5 mm [0.177"]

The figures below show representative stress-strain curves for the tests (the plotted stress is based on the gross cross-section). Note that the line for the powder-actuated fasteners follows the control test line more closely than the lines for drilled holes or self-drilling screws.

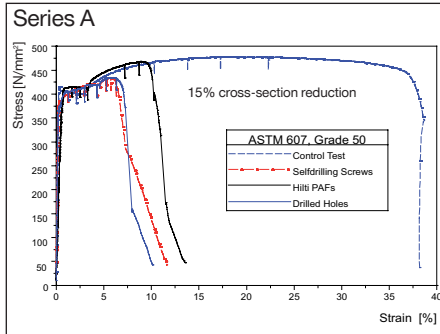

LOAD_DEFORMATION_SERIES_A

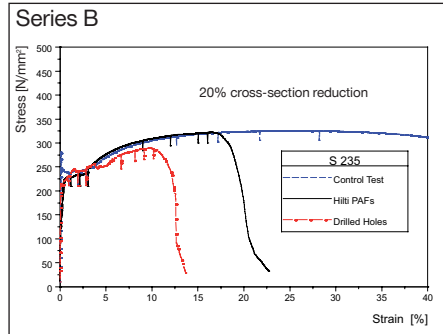

LOAD_DEFORMATION_SERIES_B

The test results were evaluated in terms of utilization as a measure of ultimate strength. Utilization is the ultimate load of a sample expressed as a percent of the ultimate load of the control test.

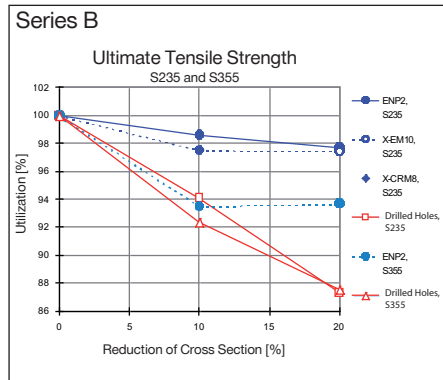
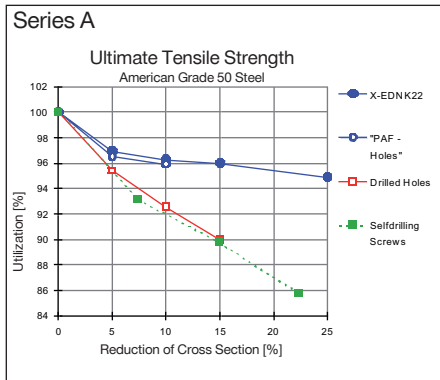

Graphs of the utilization versus cross-section reductions show that:

- The utilization for PAFs is clearly better than that of drilled holes or self-drilling screws.
- The hole left by a removed PAF has the same effect as when the PAF is left in place.
- Increasing the number of PAFs across a section from one to two or more has a proportionally smaller effect on utilization than placement of the first fastener.

More detailed information on the test program and findings is published in the paper

Powder-actuated fasteners in steel construction (and the referenced literature), published in the STAHLBAU-Kalender 2011 (Publisher Ernst & Sohn, 2011, ISBN 978-3-433-02955-8). English Reprints of the paper can be distributed per request.

5.7.2 Effect on the fatigue strength of structural steel

During the late 1970s and early 1980s, a fatigue testing program consisting of 58 tests with over 1,100 specimens was carried out at the University of Darmstadt in Germany. The reason for the research at that time was to support the use of powder-actuated fasteners for attaching noise-dampening cladding to railway bridges in Germany.

Parameters investigated in those tests are shown in following table:

Steel grade	Steel thicknesses	Stress ratio R	Imperfections
S 235 (St 37) / A36	6, 10, 15, 20, 26.5, 40, 50 mm	0.8, 0.5, 0.14, -1.0, -3.0	Fastener:
S 355 (St 52) / grade 50	[0.236, 0.394, 0.591, 1.043, 1.575, 1.969"]		- installed and pulled out, - inclined installation and pulled out - inclined installation

Loading conditions

The terminology and notation is shown in the illustration below.

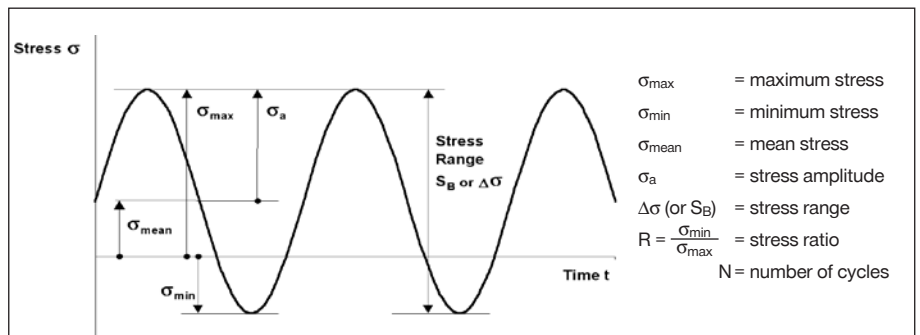

Fasteners tested

The primary fastener used in the tests was the Hilti ENP3-21 L15, the forerunner of the ENP2-21 L15. The difference is in the head shape, which has no effect on interaction with the base steel. Tests were also performed with the ENP2-21 L15, ENP3-21 D12 and the EM8-11-14 threaded stud, all of which have 4.5 mm diameter knurled shanks.

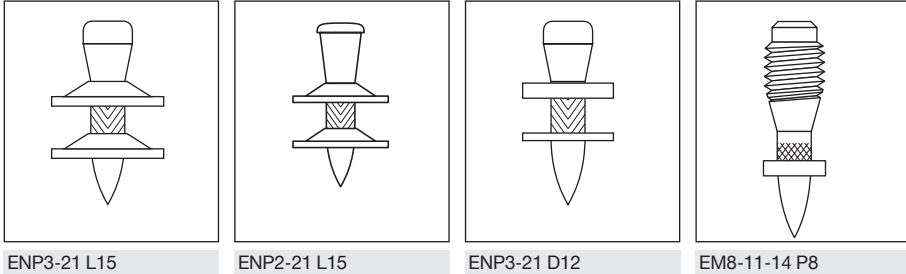

The results of the tests were evaluated by Niessner and Prof. T. Seeger from the University of Darmstadt in accordance with the provisions of Eurocode 3. An example plot of one test series is given at the right. The graph allows for a comparison with European fatigue categories 90 (m = 3) and 100 (m = 5) as well as American categories according to AWS-provisions.

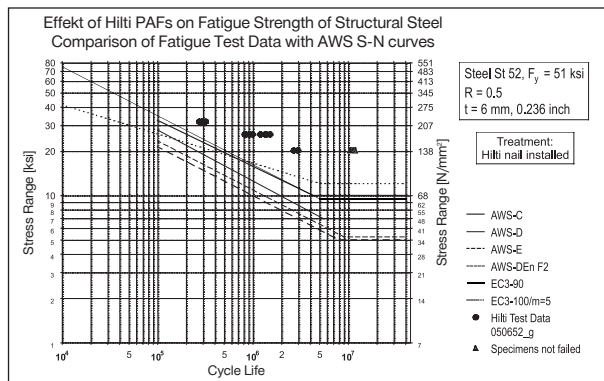

Conclusions

- The effect of driving a Hilti powder-actuated fastener on the fatigue strength is well known and predictable.
- The constructional detail “Effect of powder-actuated fasteners on base material” (unalloyed carbon steel) was evaluated by Niessner and Seeger from the University of Darmstadt in compliance with Eurocode 3.
- The EC 3 detail category 90 with m = 3 or the detail category 100 with m = 5 is alternatively applicable.
- Wrong fastener installations as popped out or inclined fasteners are covered. Piston marks in the base material due to wrong use of the tool without a fastener or notches due to fasteners failed during the installation have to be removed by appropriate measures.



More detailed information on the evaluation of the test data and the test program is published in the paper “Fatigue strength of structural steel with powder-actuated fasteners according to Eurocode 3” by Niessner M. and Seeger T. (Stahlbau 68, 1999, issue 11, pp. 941-948).

English reprints of this paper can be distributed per request.

6. Concrete base material

6.1 Anchoring mechanisms

The following three mechanisms cause a powder-actuated fastener to hold in concrete:

- Bonding / sintering
- Keying
- Clamping

These mechanisms have been identified and studied by analyzing pull-out test data and by microscopic examination of pulled-out fasteners and the concrete to fastener interface.

Bonding / sintering

When driving a fastener into concrete, the concrete is compacted. The intense heat generated during driving causes concrete to be sintered onto the fastener. The strength of this sintered bond is actually greater than that of the clamping effect due to reactive forces of the concrete on the fastener.

The existence of the sintered bond is demonstrated by examining pulled-out fasteners. The fastener surface, especially in the region of the point, is rough due to sintered-on concrete, which can only be removed by using a grinding tool.

When performing pull-out tests, the most common failure mode is breakage of the sintered bond between the concrete and the fastener, especially at and near the point.



Keying

The sintered material forms ridges on the fastener surface. These ridges result in a micro-interlocking of the fastener and the concrete.

This anchoring mechanism is studied by examining pulled-out fasteners under a microscope. As in the case of sintering, keying is primarily active in the region of the fastener point.

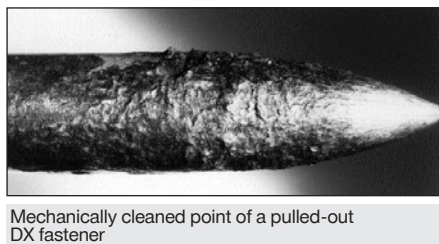

Clamping

The compressibility of concrete limits the buildup of compressive stress around the driven fastener. This in turn limits the effectiveness of clamping as an anchoring mechanism.

The tendency of stressed concrete to relax further reduces the compressive stress and hence the clamping effect. For these reasons, clamping of the fastener shank contributes only insignificantly to the total pull-out strength.

Concrete failure

Concrete cone failure is occasionally observed when using a testing device with widely spaced supports. The fact that the concrete failed indicates that the fastener bond to the concrete was stronger than the concrete.

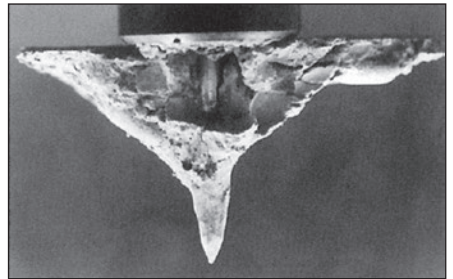

6.2 Factors influencing resistance to pull-out

Factors that can affect the pull-out strength of fastenings to concrete include:

- Depth of penetration into the concrete
- Concrete parameter (compressive strength, grain structure, direction of concrete placement)
- Distance to concrete edge and fastener spacing

Depth of penetration h_{ET}

Fasteners that are driven deeper typically have a higher resistance to pull-out. This relation is best shown by placing groups of fasteners with different driving energy and comparing the results for each group with the others. The result of such a test is shown in the graph at the right. Note that fastener driving failures were not considered in calculation of the average ultimate load, $N_{u,m}$.

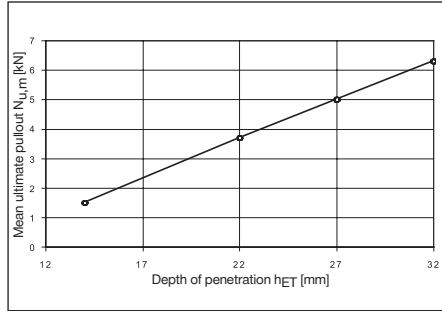

The value of increasing the depth of penetration in order to increase pull-out strength is limited by the increasing fastener driving failure rate. Provided that the penetration depth is the same, fastenings in concrete with a higher compressive strength hold better than fastenings in lower strength concrete. The ability to exploit this

characteristic is also limited by increased fastener driving failure rate with higher strength concrete. As could be expected, the depth of penetration at which the failure rate is at a minimum decreases with increasing concrete strength.

Pull-out strength and fastener driving failure rate both increase with increasing penetration depth. The optimum depth of penetration is taken as the depth at which the yield in terms of pull-out strength begins to decrease. This is within a range of 18–32 mm depending on the grade and age of the concrete as well as the strength of the fastener.

$$\text{yield} = N_{u,m} \cdot \left(\frac{100 - p}{100} \right)$$

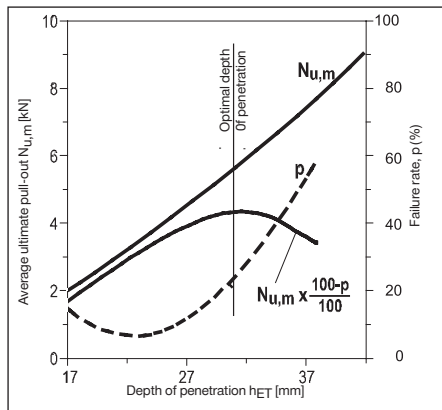

Concrete parameters

The concrete parameters (such as the type and size of concrete aggregates, type of cement and the location on top or bottom surface of a concrete floor) do affect the fastener driving failure rate, sometimes significantly.

Fastener driving failures are caused by the fastener hitting a hard aggregate, such as granite, located close to the concrete surface. A hard aggregate can deflect the fastener and in a severe case, the fastener may bend excessively,

leading to concrete fracture in a cone shape and no hold being obtained by the fastener.

In case of slight fastener bending, concrete spalling may occur at the surface. However, because pull-out strength is obtained mostly in the area of the fastener point, concrete spalling has little effect on the permissible load of the fastening.

Softer aggregates such as limestone, sandstone or marble may be completely penetrated when hit by the fastener.

Overhead fastening is usually associated with a higher rate of fastener driving failure than floor fastening. This is due to the distribution of the aggregates within the concrete. Large aggregates tend to accumulate at the bottom of a floor slab. At the top, there is a greater concentration of small aggregates and fines.

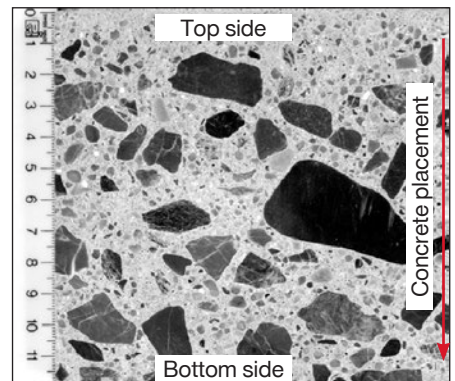

There are several possible ways of reducing the failure rate when powder-actuated fasteners are used for fastening to concrete. There are two basic ideas:

one is to reduce concrete tensile stresses near the surface and the other is to delay the effect of these stresses.

Pre-drilling the concrete (DX-Kwik)

By pre-drilling a very small hole (5mm diameter, 18 or 23 mm deep), the stresses are relocated to greater depth in the concrete. Fasteners placed with DX-Kwik are surrounded by a stress “bulb” located deep in the concrete. With this method, virtually no fastener driving failures occur.

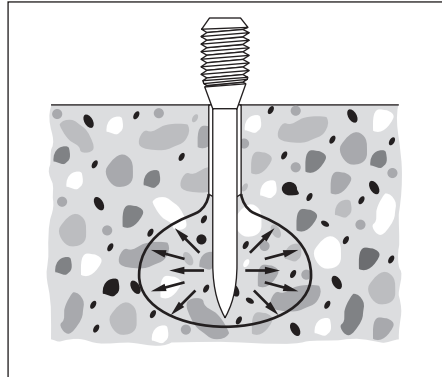

Spall stop fastener guide

A spall stop is a heavy steel fastener guide. Its weight and inertia counteract the stresses at the surface for a very short time. This allows redistribution of the stresses to other parts of the concrete.

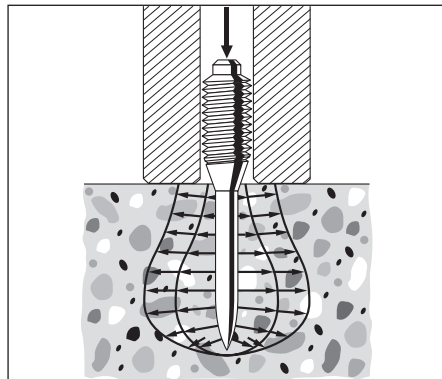

Changing from a long to a short fastener reduces the magnitude of the stresses and thus improves stick-rate.

Edge distance and fastener spacing

If fasteners are placed too close to the concrete edge, pull-out load capacity will be reduced. Minimum edge distances are therefore published with a view to reducing the effect edges have on pull-out strength. The corresponding data has been obtained from tests.

Additional provision is made for fastener spacing when positioned in pairs or where fasteners are placed in rows along a concrete edge.

These edge distances and spacing also have the purpose of helping to prevent concrete spalling and/or cracking due to fastening. However, spalling has generally only an insignificant influence on pull-out strength.

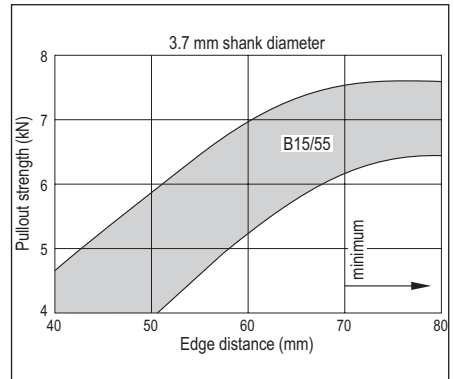

6.3 Effect of time on pull-out resistance

The effect of age on pull-out strength has been investigated in comprehensive tests.

The main concern is, in fact, the effect of concrete relaxation in the area around the driven fastener.

This graph provides an overview of tests performed with DX-Kwik fasteners. Since standard DX fastenings have the same anchoring mechanism, this statement is also valid for standard DX fastenings. The test results indicate very strongly that relaxation of the concrete has no detrimental effect on the pull-out resistance of DX fastenings. The test data also shows that sintering and keying are the dominant anchorage mechanisms because they do not rely on friction between the fastener and the concrete.

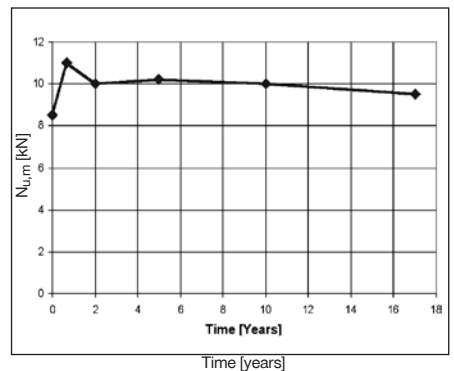

6.4 Effect on concrete components

Fastenings in the compression zone of the structure have no effect on concrete compressive resistance as long as detailed provisions on edge distance and spacing are complied with.

Fastenings in the tensile zone are subject to the following provisions:

- a. Installations on plain load-bearing components such as concrete walls or ceilings are generally possible without restrictions as the load-bearing behaviour of these components is only negligibly affected by the fasteners. The predominant condition is static loading. This statement is based on experimental investigations carried out at the Technical University of Braunschweig, Germany.
- b. Fastenings in reinforced concrete beams:

it has to be ensured that the main reinforcement steel will not be hit or penetrated by the DX fasteners. This measure of precaution is mainly founded on the reduction of the ultimate strain of the steel reinforcement. Exceptions are possible when the structural engineer responsible for design is consulted.

- c. Fastenings in pre-stressed concrete members:
it has to be ensured that the pre-stressing steel reinforcement or cables will not be hit or penetrated by the DX fasteners.

If the concrete is too thin, concrete will spill off on the rear surface. The minimum thickness of concrete depends on the shank diameter of the fastener used.

Fastener shank diameter d_{nom} (mm)	Minimum concrete thickness h_{min} (mm)
3.0	60
3.5 / 3.7	80
4.5	100
5.2	100

7. Masonry base material

7.1 General suitability

Direct fastening technology can also be used on masonry. The joints between bricks or blocks and the covering plaster layer on virtually all types of masonry (exception for

lightweight aerated concrete blocks) provide an excellent substrate for light-duty and secondary fastenings.

Suitability table: DX fastening on masonry

Masonry material	Unplastered masonry Fastenings in mortar joints* (joint width ≥ 10 mm)	Fastenings in masonry blocks or bricks	Plastered masonry Fastening in plaster (thickness ≥ 20 mm)
Clay brick			
solid	++	+	++
vertical perforated	++	---	++
horizontally perforated	++	---	++
Clay clinker			
solid	++	+	++
vertical perforated	++	---	++
Sand-lime block			
solid	++	++	++
perforated	++	++	++
hollow	++	++	++
Aerated concrete	---	---	---
Lightweight concrete			
solid	++	-	++
hollow	++	-	++
Hollow concrete	++	+	++
Slag aggregate			
solid	++	-	-
perforated	++	-	++
hollow	++	-	++

++ suitable

+ limited suitability

- not fully investigated

--- not suitable

*) Joints must be completely filled with mortar

The above table is based on laboratory and field experience. Because of the wide variety of types and forms of masonry in use worldwide, users are advised to carry out tests on site or on masonry of the type and form on which the fastenings are to be made.

8. Temperature effects on the fastening

8.1 Effect of low temperatures on fasteners

Steel tends to become more brittle with decreasing temperature. Increased development of natural resources in Arctic regions has led to the introduction of steels that are less susceptible to brittle failure at subzero temperatures. Most siding and decking fasteners are used to fasten the liner sheets of an insulated structure and are not exposed to extremely low

temperatures during service. Examples of situations where the fastenings are exposed to extremely low temperatures during their service life are:

- Fastenings securing cladding in single-skin construction
- Construction sites left unfinished over a winter
- Liner sheets in a cold-storage warehouse

Low temperature embrittlement

The susceptibility of fasteners to become brittle at low temperatures can be shown by conducting impact bending tests over a chosen temperature range. The ability

of Hilti drive pins to remain ductile over a temperature range from +20°C to -60°C is shown clearly by the fact that the impact energy required remains nearly constant throughout this temperature range.

Impact bending test - DSH57 (4.5 mm diameter, HRC 58 ± 1)

Temperature		Impact energy (foot-pounds)			Impact energy (Joules)		
°F	°C	minimum	maximum	mean	minimum	maximum	mean
68	20	35.1	>36.1	>36.1	47.6	>48.9	>48.9
32	0	35.8	>36.1	36.0	48.5	>48.9	48.8
- 4	-20	31.4	>36.1	34.3	42.6	>48.9	46.5
-40	-40	34.4	36.5	35.7	46.6	49.4	48.4
-76	-60	35.6	36.2	35.9	48.2	49.0	48.7

Impact bending test - X-CR (4.0 mm diameter)

Temperature		Impact energy (foot-pounds)			Impact energy (Joules)		
°F	°C	minimum	maximum	mean	minimum	maximum	mean
68	20	14.8	17.0	15.9	20	23	21.6
32	0	17.7	15.5	18.3	24	21	24.8
- 4	-20	14.8	15.9	15.5	20	21.6	21.0
-40	-40	16.2	17.9	16.8	21.9	24.2	22.8
-76	-60	14.2	15.6	15.1	19.2	21.1	20.5

Impact bending test - X-CR (3.7 mm diameter)

Temperature		Impact energy (foot-pounds)			Impact energy (Joules)		
°F	°C	minimum	maximum	mean	minimum	maximum	mean
68	20	11.5	14.8	13.2	15.6	20.0	17.9
32	0	12.9	16.3	15.1	17.5	22.1	20.4
- 4	-20	13.1	15.8	14.7	17.8	21.4	19.9
-40	-40	14.2	15.8	14.8	19.2	21.4	20.1
-76	-60	12.3	15.0	13.7	16.7	20.3	18.6

Tests conducted according to DIN EN 10045 parts 1-4

Distance between supports = 22 mm

The symbol ">" indicates no breakage of the specimens. In the other cases, about 50% of the specimens suffered breakage.

8.2 Effect of low temperatures on fastenings to steel

Effect of low temperatures on pull-out strength

Tests show that very low temperatures tend to increase pull-out strength with both standard zinc-plated fasteners and with the stainless steel. The results of two tests are summarized below. The fasteners were

driven at room temperature and tested at -40°C to -70°C. A control sample was tested at 20°C. Explanations for the greater strength at low temperatures include increase in the strength of the zinc that is displaced into the knurling as well as increased strength of the fusing at the point of the fastener.

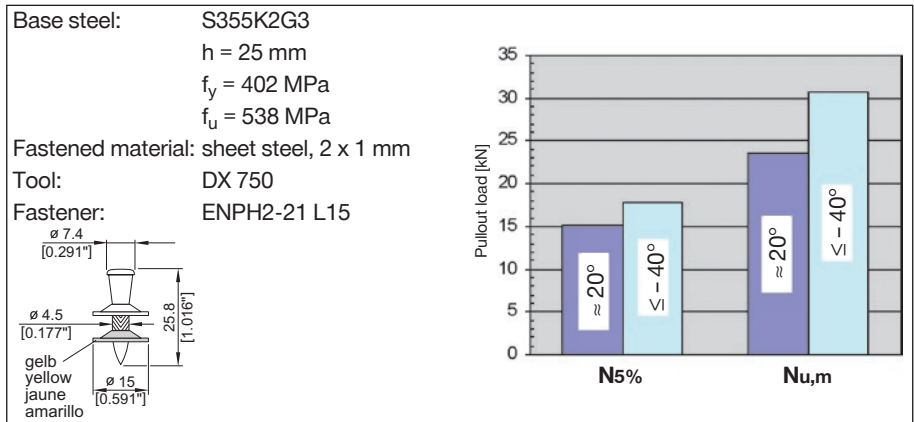

Base steel : $h = 20 \text{ mm}$
 $f_u = 450 \text{ MPa}$
 Fastened material : none
 Tool : DX 750 G
 Fastener : X-CRM8-15-12 FP10

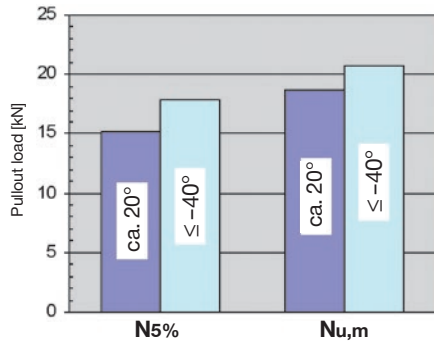
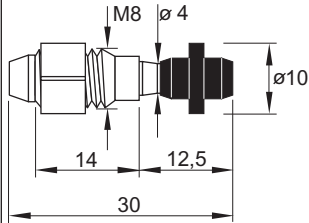

Two facts stand out from this testing:

- Pull-out strength increased as temperature decreased
- Pull-out from the base steel was the only mode of failure observed. There were no fractures!

8.3 Fire rating of fastenings to steel

Standard zinc-plated, thermally hardened steel fasteners

When subjected to high temperatures as in a fire, both powder-actuated fasteners

and structural steel lose strength. Data for standard zinc-plated, thermally hardened fasteners and structural steel are plotted in the graph below.

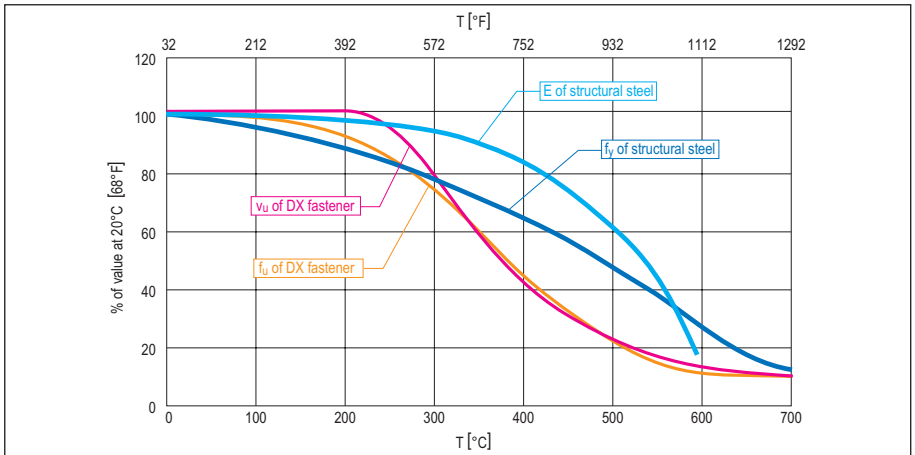

Up to about 300°C [572°F], the strength loss for DX fasteners is roughly proportional to the yield strength loss of structural steel. At 600°C [1112°F], DX fasteners have about 12% of their 20°C [68°F] strength left and structural steel about 26%. Since DX fasteners obtain their high strength through a thermal hardening process, the loss in strength at elevated temperatures is proportionally greater than for structural steel.

The relevance of different strength losses has to be evaluated in the context of the proportion of the material strengths that are actually exploited in a design. In a design calculation, it is conceivable that some steel will actually reach yield stress.

The material strengths of an X-ENP-19 L15 fastener is 30 kN [6.74 kips] in tension and 18.6 kN [4.18 kips] in shear respectively. The recommended working load in tension and shear for an X-ENP-19 L15 16 gauge (1.5 mm) fastening is 4.7 kN [1.057 kips] in tension and 4.6 kN [1.034 kips] in shear, respectively. Thus, the exploitation of the X-ENP-19 L15 strength at about 600°C is only 16 to 25% compared to about 74% for structural steel.

In a fire, powder-actuated fastenings will not be the governing factor. If the fire protection requirements permit the use of structural steel, then powder-actuated fastening can also be used without negative impact on fire protection.

CR500 stainless steel fasteners Hilti X-CR/X-CRM fasteners are much more resistant to loss of strength at high temperatures than standard fasteners. The effect of temperature on ultimate shear stress of stainless fasteners made of CR500 was determined in single lap joint shear

tests by the Swiss Federal Laboratory for Materials Testing and Research (EMPA). The results are plotted in the diagram below. This test was done by shearing 4.5 mm diameter fasteners that were inserted in steel plates with 4.6 mm diameter drilled holes.

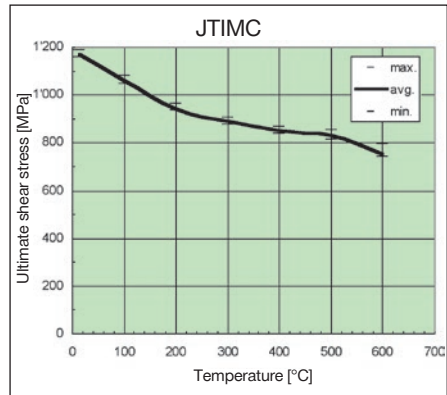
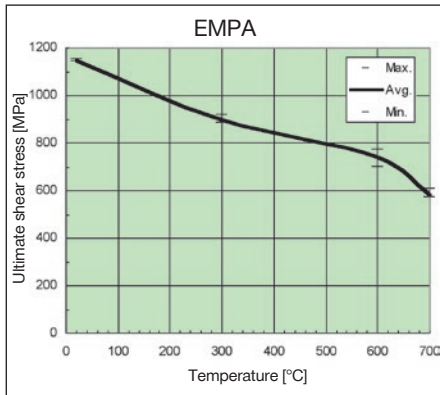

In Japan, similar tests were carried out by JTICM (Japan). These tests were done by driving a 4.5 mm diameter X-CR nail through a 6 mm steel plate into a second 6 mm thick steel plate and shearing the two plates. From the graph it is apparent that the results are nearly the same.

At 600°C, the CR500 material has 64% of its 20°C shear strength left. By comparison, standard fasteners have only 12% and structural steel only about 26%. The excellent fire resistance of the CR500 material alone justifies its use for some applications.

8.4 Fire rating of fastenings to concrete

Concrete is weakened and damaged by fire but not as quickly as steel. In ISO-standard fire tests conducted with DX-Kwik fastenings at the Braunschweig Technical University in Germany the only failure mode was fracture of the nails.

The actual test data are shown in the table below:

X-DKH 48 P8S15 DX-Kwik fastener, 4.0 shank

Tested in crack width ΔW (mm)	Tensile load, F (N)	Fire resistance/ time to failure (minutes)	Failure mode
0.2	250	103	Nail fracture
0.2	250	107	Nail fracture
0.2	350	73	Nail fracture
0.2	350	91	Nail fracture
0.2	500	56	Washer pullover
0.2	500	92	Nail fracture
0.2	500	93	Nail fracture

The stress in the fasteners at failure was calculated and plotted so that a plot of stress versus time resulted.

The characteristic failure stress curve from the previous graph can be used to calculate the failure load for various shank diameters with exposure to fire of different lengths of time. The calculated failure loads for 3.7, 4.0 and 4.5 mm shank diameter fasteners after 60, 90 and 120 minutes exposure to fire are shown in the table below.

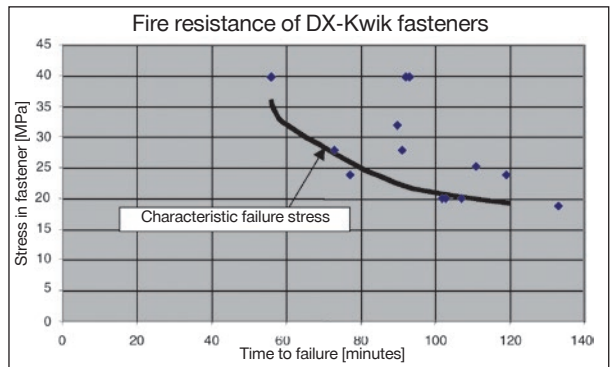

Failure loads for various shank diameters and fire exposure times

Shank diameter (mm)	Fire exposure time and failure stress		
	60 minutes	90 minutes	120 minutes
3.7	32.1 MPa 340 N	22.3 MPa 240 N	19.1 MPa 200 N
4.0	400 N	280 N	240 N
4.5	510 N	350 N	300 N

This table can be used to determine recommended loads for the ISO fire resistance required.

9. Design concepts

The recommended working loads N_{rec} and V_{rec} are suitable for use in typical working load designs. If a partial factor of safety design method is to be used, the N_{rec} and V_{rec} values are conservative when used as N_{Rd} and V_{Rd} . Alternatively, the design resistance may be calculated from the recommended loads by multiplying by the factor 1.4, which considers the uncertainties from the load on the fasteners. Exact values

for N_{Rd} and V_{Rd} can be determined by using the safety factors where given and or reviewing test data. Based on cyclic tests it can be stated that DX fastenings can be said to be robust, even when the actual loading turns out to be in part cyclic. Design loads (characteristic strength, design resistance and working loads) for the **X-HVB** shear connector are listed and specified per design guideline.

The designer may encounter two main fastening design concepts:

Working load concept

$$N_S \leq N_{\text{rec}} = \frac{N_{\text{Rk}}}{\gamma_{\text{GLOB}}}$$

where γ_{GLOB} is an overall factor of safety including allowance for:

- errors in estimation of load
- deviations in material and workmanship

and N_S is in general a characteristic acting load.

$$N_S \equiv N_{\text{Sk}}$$

Partial factors of safety

$$N_{\text{Sk}} \cdot \gamma_{\text{F}} = N_{\text{Sd}} \leq \frac{N_{\text{Rk}}}{\gamma_{\text{M}}} = N_{\text{Rd}}$$

where:

- γ_{F} is a partial factor of safety to allow for errors in estimation on the acting load and
- γ_{M} is a partial factor of safety to allow for deviations in material and workmanship.

The characteristic strength is defined as 5 % fractile:

$$N_{Rk} = N_{u,m} - k \cdot s$$

The k factor is a function of the sample size and the accuracy required. The characteristic strength of fastenings to concrete is determined based on a 90% probability while fastenings to steel are based on a 75% probability.

Structural analysis of the fastened part (e.g. roof deck panel or pipe hung from a number of fastenings) leads to calculation of the load acting on a single fastening, which is then compared to the recommended load

(or design value of the resistance) for the fastener. In spite of this single-point design concept, it is necessary to ensure adequate redundancy so that failure of a single fastening will not lead to collapse of the entire system. The old saying “one bolt is no bolt” can also be applied to DX fastening.

For standard DX fastenings on concrete, a probability-based design concept based on multiple fastening is applied in order to allow for fastener driving failures and the large scatter in holding power observed. This concept applies to tensile as well as shear loading and is described in following chapter.

10. Determination of technical data for fastening design

The determination of technical data is based on the following tests:

- Application limits
- Tensile tests to determine pull-out and pull-over strength
- Shear tests to determine bearing capacity of the attached material and the base material.

These tests are described in more detail in the sections “Steel and other metal base material” and “Concrete base material”.

10.1 Fastenings to steel

Failure loads in tension and in shear are normally distributed and the variation coefficient is $< 20\%$. The test data for each test condition are evaluated for the average and characteristic values. The characteristic value is based on the 5% fractile for a 75% probability.

The application range of the fastener is determined by application limit test where fasteners are set on steel plates of thickness ranging from the minimum recommended thickness $t_{II,min}$ to full steel (≥ 20 mm) and varied plate strength.

The application limit is reached when 1 shear off failure with 30 fasteners tested occurs, or if a detrimental effect on the load values (resistance) occurs.

Due to the small scatter in failure loads fastenings in steel can thus be designed as single points, although good engineering practice should be kept in mind. System redundancy must be always ensured.

10.2 Profile sheet fastenings

In addition to general fastenings to steel, specific data applies to profile sheet fastenings:

Cyclic loading

Profile sheet fastenings are subjected to repeated loading to simulate wind effects. Cyclic pull-through tests are additional optional tests where the failure load at 5,000 cycles is determined.

The design value of the pull-through resistance for repeated wind loads is the design value of the static pull-through resistance multiplied by a reduction factor of α_{cycl} .

- If cyclic tests are carried out:

$$\alpha_{cycl} = 1.5 (N_{Rk,cycl} / N_{Rk,sta}) \leq 1$$

(The factor 1.5 takes the different safety levels for fatigue and predominately static design into account)

- If no cyclic tests are carried out:

$$\alpha_{cycl} = 0.5$$

Sheet bearing capacity

Profile sheet fastenings may be subjected to shear stresses from building movements or thermal dilatation of the sheets. Tests are undertaken to prove the suitability of the fastenings to support the deformations imposed.

For this, shear tests are carried out using a substrate of the minimum and maximum thickness and 2 layers of profile sheet of the thickness specified.

The fastening is considered suitable if an elongation of 2 mm is achieved without the sheet coming loose or showing an excessive reduction in pull-out load capacity. In this case, no consideration of forces of constraint is required since sufficient ductility is provided by the fastening due to hole elongation.

Standardization

The pull-over strength of profiled sheet fastenings is given with reference to core sheet thickness. Ultimate load data is standardized to the minimum sheet thickness and strength as specified by the relevant sheet standard. The correction applied is as follows:

$$F_{u'} = F_u \cdot \frac{t_{min}}{t_{act}} \cdot \frac{f_{u,min}}{f_{u,act}}$$

10.3 Fastenings to concrete (standard DX / GX / BX)

The failure loads in tension and shear show a large scatter with a variation coefficient of up to 60%. For specific applications, fastener driving failures may be detected and the fasteners replaced (e.g. threaded studs). For others, however, detection may not be possible (e.g. when fastening wooden battens) and this must be taken into consideration.

The design resistance is therefore determined for:

- failure loads without considering fastener driving failures
- failure loads considering a 20% rate of fastener driving failure

Evaluation of technical data and design according to the single point design approach based on fractiles and a safety factor is not feasible for such systems. The characteristic value would become zero at a variation coefficient of about 50%.

The evaluation of the data and the determination of the design resistance is therefore based on a multiple fastening, i.e. a redundant design, in which the failure probability not of a single, but of a number of fasteners supporting a structure is calculated. By this system, load may be transferred between the fasteners, if slip or failure of one or more of the fasteners occurs.

Test data

The test data for the fastener is consolidated to form a master pullout load distribution.

Static system

Two static systems are examined

- A suspended beam allowing unrestrained flexure of the beam
- A beam directly attached to the surface, which shows restrained flexure

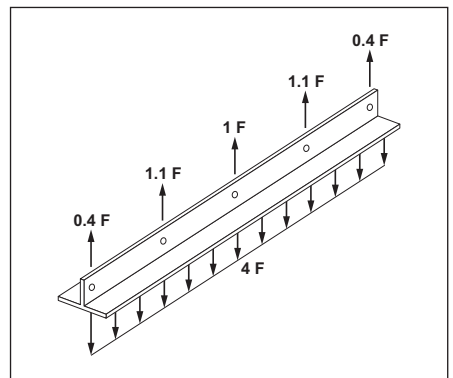

Calculation method

The calculation method used is the Monte Carlo method, by which holding values taken stochastically from the master distribution are attributed to the individual fasteners of the system and the system is checked to determine whether the imposed line load can be supported. By performing a large number of such simulations, statistical information on the failure probability of a system under a given line load is obtained. Hidden setting failures can also be considered with this method.

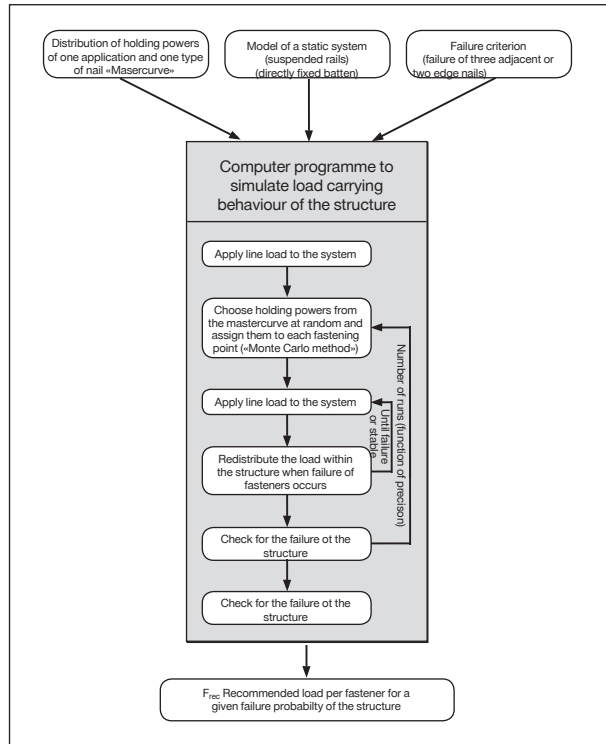

Design parameters

The design is based on the following parameters:

- Failure probability: $1 \cdot 10^{-6}$
- Number of fasteners: 5
- Line load uniformly distributed
- Failure criterion: 2 edge or 3 central fastenings

The result is expressed in recommended load per fastening.

Effect on a fastening design

The overall condition for a fastening design in practice is that redundancy of the complete system has to be ensured. The effect of the Monte Carlo approach on a design is illustrated with two examples below.

Example:

Fastening of a plumbing with five ceiling hangers.

1. Due to the stiffness (EI) of the plumbing a redistribution of the dead load (g) to the remaining hangers is given in case of two neighbouring hangers failing.

(Fixing of each hanger with one nail is sufficient.

2. The plumbing is not stiff enough to redistribute the dead load to the neighbouring hangers in case of one fastener failing.

(Each hanger has to be fastened with five nails.

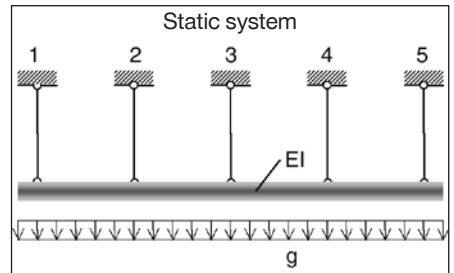

10.4 DX fastenings to concrete (DX-Kwik)

Failure loads in tension and shear are log-normally distributed and the variation coefficient is <20 %. The test data is evaluated to yield the 5% fractile based on a 90% probability. The recommended working loads are obtained by applying a global safety factor of 3 for tension and shear.

The determination of technical data for cracked concrete (tensile zone) is based on tensile tests. Shear tests in cracked and uncracked concrete give similar results and are therefore not performed.

Failure loads in cracked concrete show a higher variation coefficient. Test data is also evaluated to yield the 5% fractile. The recommended load for the tensile zone is taken as the smaller of the following values:

- $N_{rec} = N_{RK} / \gamma_{GLOB}$ $\gamma_{GLOB} = 3.0$ for 0.2 mm crack width
- $N_{rec} = N_{RK} / \gamma_{GLOB}$ $\gamma_{GLOB} = 1.5$ for 0.4 mm crack width.

The application range of the fastener is determined by application limit test where fastenings are made on concrete of varying strength and age according to the application conditions specified (pre-drilling and setting). The attachment height is kept at the lower end of the range specified. The application limit is reached, if the failure rate exceeds 3% or the pull-out values strongly deviate from a lognormal distribution. The sample size is 30 per condition.

10.5 Fastener design in the USA and Canada

Testing of powder-actuated fasteners is carried out according to the ICC-ES AC 70 acceptance criteria and ASTM E 1190 standard test method. The test procedure covers tensile and shear testing in steel, concrete and masonry.

The determination of the allowable (recommended) load is shown below. The recommended working load is derived from the test data by taking the average failure load or the calculated characteristic load divided by a global safety factor.

$$P_a = V_a = F_{all} = \frac{F \cdot R \cdot R_f}{\Omega} \quad (3-1)$$

where:

- F = Average ultimate load [lbf (N)] of the test series.
- Ω = Safety factor determined in accordance with Section 3.3.2.
- R = Most severe base material reduction factor determined in accordance with Section 3.3.3.1, 3.3.3.2, or 3.3.3.3, as applicable.
- R_f = Fastener based reduction factor, determined in accordance with Section 3.3.3.4, as applicable.

Exception: When testing satisfies the alternate sample size described in Section 8.1 of ASTM E1190 (the COV from ten tests is 15 percent or greater), F shall be taken as the lowest ultimate load of the ten tests and Ω shall be taken as 5.

3.3.2 Safety Factor, Ω : The safety factor shall be determined using Equation 3-2.

$$\Omega = \frac{3.5}{(1 - 2COV)} \geq 5 \quad (3-2)$$

Part 2:

Fastener selection guide

1. Selecting the right fastener

These considerations are used to determine a suitable powder-actuated (DX), gas-actuated (GX) or battery-actuated (BX) fastener for an application.



Detailed technical information for the selected fastener family is found on its product information sheet on the displayed pages.

For some applications, two or more fastener families are listed as suitable. The final selection is influenced by your specific application requirements, available tools and technical data found on the product sheets.

Regional differences in building methods, materials, trade preferences, available tools, etc. also influence fastener selection. Therefore, designers and specifiers are advised to consult the local Hilti website and make use of the local Hilti technical advisory service.

Corrosion

Corrosion may have a major influence on the suitability of a fastener for an application and therefore also on fastener selection. In order to provide a basis for judging the suitability of fasteners, it is useful to categorise applications in three classes:

- Non-safety relevant, temporary fastenings (e.g. fastenings of wooden kickers in concrete formwork)
- Non-safety relevant, permanent fastenings (e.g. metal track fastenings for drywall)
- Safety relevant, permanent fastenings (e.g. profiled metal sheet fastenings in roof and walls)

Non-safety-relevant , temporary and permanent fastenings: zinc-plated fasteners made of normal carbon steel can be used without restriction. Corrosion and related damages can, however, reduce the capacity of fasteners.

Safety-relevant, permanent fastenings: the restrictions described below apply:

- In any case where there is a restriction to use galvanized carbon steel fasteners if they are exposed to weather or if they are inside and subject to repeated wetting as from condensation. The galvanization (typically in a range from 5 to 20 microns of Zn) provides corrosion protection during transport and construction, during which exposure to weather can never be completely prevented. If the fastenings are exposed to repeated wetting or weather during their service life, the use of galvanized carbon steel fasteners is prohibited and stainless steel fasteners must be used. This safety measure must be observed without exception because the corrosion of galvanized steel fasteners leads not just to material loss but also to hydrogen embrittlement. Hydrogen embrittlement can easily result in fracture of the fastener at very low load.
- Referring to the above-mentioned example of profiled metal sheet fastening for roofs and walls, the use of galvanized steel fasteners is allowable only where wetting of the fastener is not to be expected. This applies in general to inside skins of two skin, insulated roofs and walls enclosing dry and closed rooms. This is the classic application area for X-ENP 19 galvanized fasteners.
- For special applications like swimming pools or tunnels, highly corrosion-resistant resistant stainless steel materials are recommended. See also Part 4, Chapter 4. Please consult Hilti in such cases

Contact corrosion is taken into consideration by observing common rules concerning acceptable material combinations. Parts made of less noble metals are subject to increased corrosion if they are in electrochemical contact with a larger part made of a more noble metal, provided of course that an electrolyte is present. Fasteners that are used in wet areas must be at least as noble or better, nobler than the fastened part. The effect of contact corrosion is shown in the table below. This information is especially applicable to stainless steel

X-CR, X-ST and X-R fasteners because these are suitable for safety-relevant, permanent application in outdoor areas or areas otherwise exposed to corrosion.

Fastened part	Powder- and gas-actuated fastener:	
	Zinc-plated carbon steel	Stainless steel
Construction steel (uncoated)	s	s
Galvanized steel sheet	s	s
Aluminum alloy	d	s
Stainless steel sheet	d	s

s Negligible or no corrosion of fastener
d Heavy corrosion of fastener

Accelerated corrosion of a fastener due to contact corrosion can take place only in the presence of an electrolyte (moisture from precipitation or condensation). Without this electrolyte – e.g. in dry inside rooms – zinc-plated fasteners can be used in connection with more noble metals.

2. Concrete fastener selection

What determines nail performance

Hilti Direct Fastening systems are designed to achieve maximum performance in a wide range of applications. But there is a large variety of nails types and elements for various direct fastening concrete applications. To select the appropriate nail for an application, some important influencing parameters need to be considered:

- a) concrete properties,
- b) nail design and features
- c) the fastening system used
- d) nail embedment depth
- e) fastening tools and energy level

a) Concrete properties

A nail penetrating concrete needs to create a hole for the shank by crushing and compacting the concrete and also needs to withstand hitting hard aggregates. The resulting holding value achieved by the nail is linked to its diameter and embedment depth.

High penetrability and compactability lead to high stick rates and holding values.

Note: Concrete compressive strength alone is not decisive for nail performance.

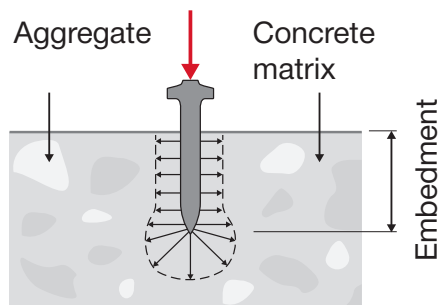

Three concrete types can be roughly distinguished:

- S**
Soft

 - Low compressive strength, e.g. $f_{c, cube} = 20 - 45$ MPa
 - Small to medium-size aggregates, e.g. soft limestone
 - Example: lightweight concrete
- T**
Tough

 - Medium to high compressive strength, e.g. $f_{c, cube} = 45 - 65$ MPa
 - Medium size aggregate, e.g. limestone, pit gravel
 - Example: normal weight concrete
- V**
Very Tough

 - High compressive strength, e.g. $f_{c, cube} \geq 65$ MPa
 - High proportion of large and mainly hard aggregates, e.g. quartz, granite
 - Example: high performance concrete, very old concrete.

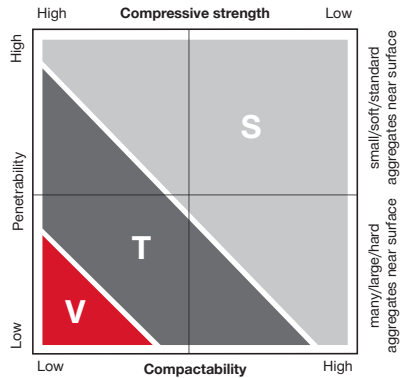

Note: $f_{c, cube}$ = Compressive strength of concrete cube (150 mm edge length)

b) Nail design and features

Penetrability and compactability, i.e. a nail's ability to penetrate and compact the concrete, are strongly influenced by three nail design features:

Point type

The point type and the reduction of the diameter in the area of the tip allows a significantly improved penetration behaviour in concrete.

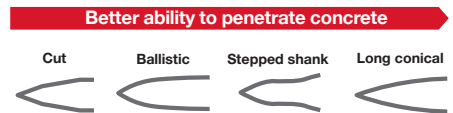

Nail geometry

Length and diameter also affect how easily the nail penetrates the concrete.

Nail hardness

A harder nail is easier to drive into tougher concrete. However, if the nail is too hard, it can break instead of bending when it hits a hard aggregate in the concrete.

c) Fastening systems used

Hilti Direct Fastening Systems help to ensure that nails are correctly driven by achieving maximum nail perpendicularity, good nail guidance and thorough use of the appropriate driving energy.

Perpendicularity

Hilti Direct Fastening tools help to keep nails perpendicular to the working surface, thus reducing failures caused by nails driven at an angle. During the fastening process, Hilti Direct Fastening tools have to be maintained perpendicular to base material as much as possible. Please refer to product instructions for use and tool operation manuals for details.

Nail guidance

Due to excellent nail guidance in the tool and the use of solid washers, the nail leaves the tool at the intended angle.

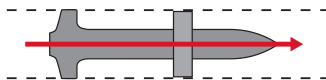

d) Nail embedment depth

Another factor that influences nail performance is embedment depth. A nail that can be driven deeper has the ability to achieve higher loads. However, there are two side effects if a nail needs to be driven deeper.

- stick rate can decrease
- higher driving energy is required as the nail must penetrate further into the concrete

e) Fastening tools and energy levels

Nail driving energy released by a Hilti tool is precisely controlled to help achieve the desired embedment depth reliably

Powder-actuated tools (DX)

Embedment depth of a nail can be influenced by selecting the right cartridge color and adjusting the power setting of powder-actuate tools (DX) on concrete, where applicable. Hence, it is crucial to understand how the different tools in combination with the various cartridges vary in terms of energy generation. Use that knowledge to pick the right tool and the right cartridge to help achieve the required embedment depth and reach the optimum nail load performance.

Gas-actuated tools (GX)

Embedment depth can be influenced by adjusting the slider in the front of the tool to “+” or “-” position.

Battery-actuated tools (BX)

Embedment depth can be influenced by selecting a different nail length.

Choice of a nail for use on concrete

Three main factors that define the nail selection on concrete are:

- speed
- stick rate
- holding values

Speed

All system technologies, gas actuated-tool (GX), battery-actuated tool (BX) and powder-actuated tool (DX) offer a very high installation speed.

Stick rate

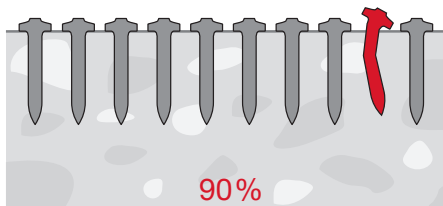

The stick rate indicates the percentage of nails that were driven correctly to carry a load.

Generally, stick rate can often be improved by combination of

- using shorter nails
(on condition that required load can still be achieved with shorter embedment)
- selecting nails from a higher nail class
(nail classes are described later in this chapter)
- using more energy by combination of tools, cartridges and energy setting
- using different technologies and nails from a higher nail class, i.e. switching from gas-actuated (GX) or battery-actuated tools (BX) to powder-actuated tools (DX)
- pre-drilling, see chapter Kwik

Holding values

Holding values provide a measure of a nail's load-bearing capability which ensures the reliable use in practical applications, consistent with their diameter and embedment depth. Nails are typically subjected to static or quasi-static actions tension, shear or combined tension and shear.

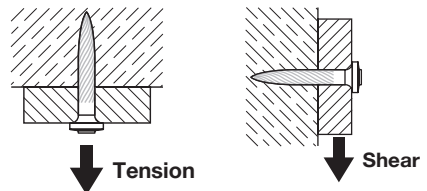

Nail Types

Different nails have been developed for various applications and conditions.











Medium duty Class I and II nails are used for load-sensitive high performance applications in tough and very tough concrete, while medium duty Class III nails are for versatile use in soft and tough concrete. Medium duty Class I, II and III nails are generally fastened with powder-actuated tools (DX)

Light duty Class IV and V nails, generally fastened with gas-actuated (GX) and battery actuated tools (BX) are typically used for applications that have lower load requirements, hence requiring shorter embedment depth. In general, Class V nails present the most economical solution as they are the least costly.

Cost is directly related to

- the manufacturing technologies involved as well as
- the material from which the nails are made.

Each higher nail class performs better under harsher conditions than the one below, but the manufacturing costs, and thus the price of the nail, increase with each nail class.

	Nail Class	Nail featured			Concrete Class	Nail examples	Applications
		Ø [mm]	Hardness [HRC]	Tip			
Medium duty	Class I	> 4.0	> 58	Long conical	  	X-AL-H 1)	Load sensitive high performance and special applications in tough and some very tough concrete.
	Class II	4.0	Up to 60	Ballastic or better	 	X-P X-U	Load sensitive high performance applications in tough concrete.
	Class III	3.5 to 3.7	Up to 58	Mostly cut	 	X-C	Versatile use in soft and tough concrete.
Light duty	Class IV	3.0 to 3.2	Up to 58	Ballastic or better	 	X-P G2/G3/B3	Use in soft and some tough concrete with shorter embedment, e.g. for track fastening to slab underside.
	Class V	2.6 to 3.0	Up to 57	Mostly cut		X-C G2/G3/B3	Use in soft concrete with shorter embedment, e.g. for track fastening.

1) X-AL-H nail is pre-mounted to X-CX ceiling fasteners

Nail class versus concrete type

Stick rate versus holding values of nail classes

Nail classes are clearly differentiated when faced with tough and very tough concrete. Depth of embedment, nail geometry, nail geometry, hardness and tip shape vary between nail classes.

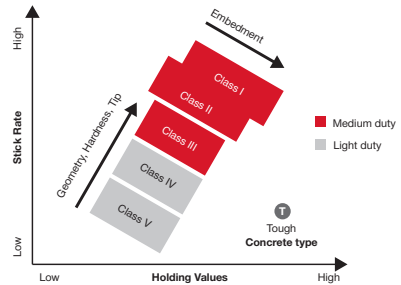

Stick rate of nail classes in different concrete types

Nail performance varies depending on the toughness of the concrete and the distribution of its aggregates. Nails of all classes perform similarly in soft concrete, but as the concrete gets tougher, the stick rate varies.

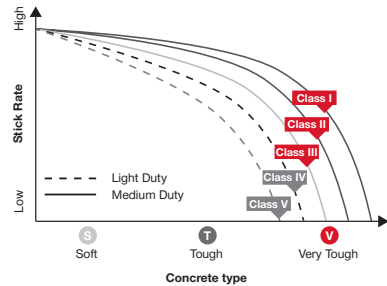

Guidelines to selecting the right nail for concrete

- Understand the application
- Be specific about important application requirements
- Get to know the Hilti range of nails
- Choose the right nail based on application requirements



Improving the stick rate can be done in three different ways:

1. Use a shorter nail (if required embedment / load still can be reached with shorter nail)
2. Select a nail from a higher nail class (move from Nail Class III to II)
3. Use more energy (energy setting) / select different technology

Example of nail selection process to improve stick rate.

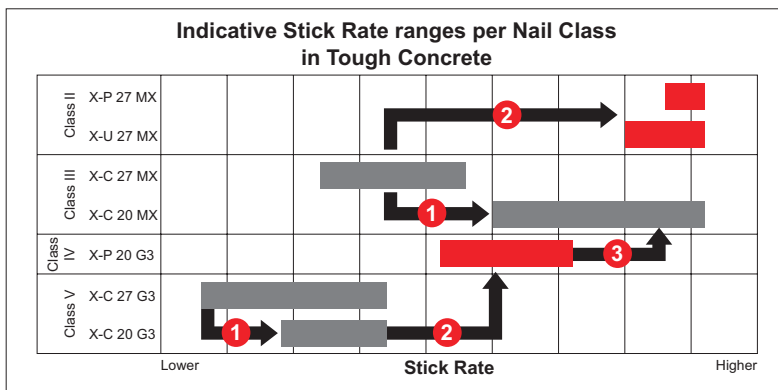

- Maximize the stick rate
- Achieve the required holding values
- Select the most cost-efficient nail
- Achieve optimum embedment depth based on selecting the appropriate cartridge and adjusting the power setting for DX systems.
 - No power and cartridge selection required for GX and BX systems.
- Other application relevant requirements, e.g. environmental conditions, corrosion, etc., must be considered.

Design concepts

The recommended working loads (N_{rec} and V_{rec}) are suitable for use in typical working load designs. If a partial safety factor design method is to be used, the N_{rec} and V_{rec} values are conservative when used as N_{Rd} and V_{Rd} . Exact values for N_{Rd} and V_{Rd} can be determined by using the safety factors where given and/or by reviewing test data. Design loads (characteristic strength, design resistance and working loads) for the **X-HVB** shear connector are listed as per design guideline.

Worldwide the designer may encounter two main fastening design concepts:

Working load concept

$$N_S \leq N_{\text{rec}} = \frac{N_{\text{Rk}}}{\gamma_{\text{GLOB}}}$$

where γ_{GLOB} is an overall factor of safety including allowance for:

- errors in estimation of load
- deviations in material and workmanship

and N_S is, in general a characteristic acting load.

$$N_S \equiv N_{\text{Sk}}$$

Partial factors of safety

$$N_{\text{Sk}} \cdot \gamma_{\text{F}} = N_{\text{Sd}} \leq \frac{N_{\text{Rk}}}{\gamma_{\text{M}}} = N_{\text{Rd}}$$

where:

γ_{F} is a partial factor of safety to allow for errors in estimation on the acting load.

γ_{M} is a partial factor of safety to allow for deviations in material and workmanship.

Structural analysis of the fastened part (e.g. roof deck panel or pipe hung from a number of fastenings) leads to calculation of the load acting on a single fastening, which is then compared to the recommended load (or design value of the resistance) for the fastener. In spite of this single point design concept, it is necessary to ensure that there is sufficient redundancy that the failure of a single fastening will not lead to collapse of the entire system. The old saying “one bolt is no bolt” applies also to Direct fastening.

3. Nomenclature / symbols

Following is a table of symbols and nomenclature used in the technical data.

Fastener test data and performance	
N and V	Tensile and shear forces in a general sense.
F	Combined force (resulting from N and V) in a general sense.
N_s and V_s	Tensile and shear forces acting on a fastening in a design calculation.
F_s	Combined force (resulting from N_s and V_s) in a design calculation.
N_u and V_u	Ultimate tensile and shear forces that cause failure of the fastening; statistically, the reading for one specimen.
N_{u,m} and V_{u,m}	Average ultimate tensile and shear forces that cause failure of the fastening, statistically, the average for a sample of several specimens.
S	The standard deviation of the sample.
N_{test,k} and V_{test,k}	Characteristic tensile and shear resistance of test data, statistically, the 5 % fractile.
N_{Rk} and V_{Rk}	<p>Characteristic tensile and shear resistance of the fastening used for fastening design; statistically, the 5 % fractile. For example, the characteristic strength of a fastening whose ultimate strength can be described by a standard Gauss type distribution is calculated by:</p> $N_{Rk} = N_{u,m} - k \cdot S$ <p>where k is a function of the sample size n and the desired confidence interval.</p>
N_{Rd} and V_{Rd}	<p>Tensile and shear design resistance of the fastening</p> $N_{Rd} = \frac{N_{Rk}}{\gamma_M} \text{ and } V_{Rd} = \frac{V_{Rk}}{\gamma_M}$ <p>where γ_M is a partial safety factor for the resistance of the fastening.</p>
N_{rec} and V_{rec}	<p>Recommended tensile and shear force of the fastening</p> $N_{rec} = \frac{N_{Rk}}{\gamma_{GLOB}} \text{ and } V_{rec} = \frac{V_{Rk}}{\gamma_{GLOB}}$ <p>where γ_{GLOB} is an overall factor of safety.</p>
M_{rec}	<p>Recommended working moment on the fastener shank</p> $M_{rec} = \frac{M_{Rk}}{\gamma_{GLOB}}$ <p>where M_{Rk} is the characteristic moment resistance of the fastener shank and γ_{GLOB} is an overall factor of safety. Unless otherwise stated on the product data sheets, the M_{rec} values in this manual include a safety factor of "2" for static loading.</p>

Fastening details

h_{ET}	Penetration of the fastener point below the surface of the base material.
h_{NVS}	Nail head standoff above the surface fastened into (with nails, this is the surface of the fastened material, with threaded studs, the surface of the base material).
t_{II}	Thickness of the base material.
t_I	Thickness of the fastened material.
Σt_I	Total thickness of the fastened material (where more than one layer is fastened).

Characteristics of steel and other metals

f_y	Yield strength of steel.
f_u	Tensile strength of steel.

Characteristics of concrete and masonry

f_c	Compressive strength of cylinder (150 mm diameter, 300 mm height).
f_{cc}	Compressive strength of cube (150 mm edge length).
$f_{c,100} / f_{c,200}$	Compressive strength of 100 mm diameter cylinder / cube with 200 mm edge length.

In some cases, building material grades are used to describe the suitable range of application. Examples of European concrete grades are C20/25, C30/35, C50/55.

Approvals, technical assessments and design guidelines are given on the product information sheets as abbreviations of the names of the issuing institutes or agencies.

Following is a list of abbreviations:

Abbreviation	Name of institute or agency / description	Country
FM	Factory Mutual (insurers' technical service)	USA
UL	Underwriters Laboratories (insurers' technical service)	USA
ICC	International Code Council	USA
SDI	Steel Deck Institute (technical trade association)	USA
CSTB	Centre Scientifique et Technique du Bâtiment (approval agency)	France
DIBt	Deutsche Institut für Bautechnik (approval agency)	Germany
SOCOTEC	SOCOTEC (insurers' technical service)	France
ÖNORM	Österreichische Norm / Austrian National Standard	Austria
SCI	Steel Construction Institute	Great Britain



ABS	American Bureau of Shipping (international classification society for ship and marine structures).
LR	Lloyd's Register (international classification society for ship and marine structures).
DNV GL	International classification society for the marine and energy industry.



4. Tips for users

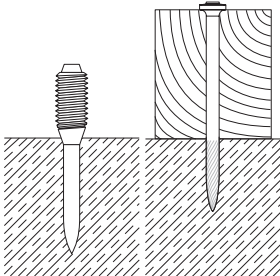

Tips for users (“Trouble Shooting”)

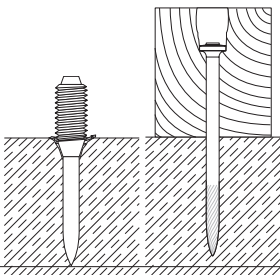
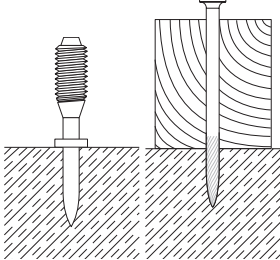
DX fastenings on concrete

Observation	Cause	Possible remedial measures
<p>Fastener properly fixed</p> 	<ul style="list-style-type: none"> • Proper*) length of fastener • Proper cartridge • Proper power setting 	
<p>Fastener penetrates too deep</p> 	<ul style="list-style-type: none"> • Fastener too short*) • Too much driving power 	<ul style="list-style-type: none"> • Use longer fastener • Reduce power setting • Use lighter cartridge
<p>Fastener does not penetrate deep enough</p> 	<ul style="list-style-type: none"> • Fastener too long*) • Too little driving power 	<ul style="list-style-type: none"> • Use shorter fastener • Increase power setting • Use heavier cartridge

*) **Rule of thumb:** The higher the compressive strength of concrete, the shorter the fastener
Proper length (mm): $L_s = 22 + t_1$ (compare, “Fastening Technology Manual” Part Product section)

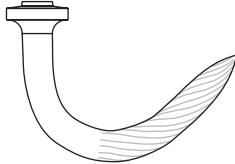
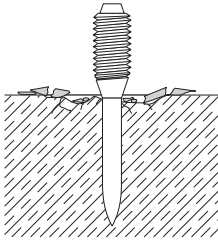
DX fastenings on concrete

Observation	Cause	Possible remedial measures
<p>Nail is bending</p> 	<ul style="list-style-type: none"> • Hard and/or large aggregate in concrete • Rebar close to surface of concrete • Hard surface (steel) 	<ul style="list-style-type: none"> • Use shorter nail • Use DX-Kwik (predrill) • Use stepped shank nail X-U 15 • Change cartridge
<p>Base material is spalling</p> 	<ul style="list-style-type: none"> • High strength concrete • Hard and/or large aggregate in concrete • Old concrete 	<ul style="list-style-type: none"> • Stud application: Use spall stop X-460-F8SS / - F10SS • Nail application: Use shorter nail Use DX-Kwik (predrill) Use X-U 15 (for highstrength precast concrete)
<p>Damaged nail head</p> 	<ul style="list-style-type: none"> • Too much driving power • Wrong piston used • Damaged piston 	<ul style="list-style-type: none"> • Reduce power setting • Use lighter cartridge • Check nail-piston-combination • Change piston

Wrong pistons can cause all the above faults: match pistons to nails!

Fastener	Piston	Piston tip
X-U, X-C, X-P	Use piston X-460-P8	

DX fastenings on steel

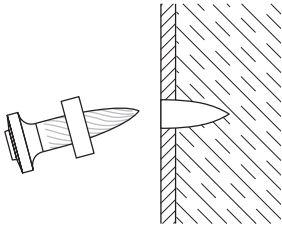
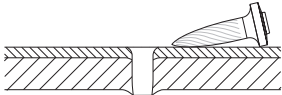
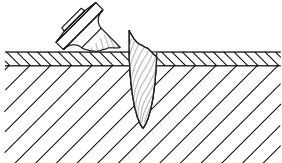
Observation	Cause	Possible remedial measures
<p>Nail does not penetrate surface</p> 	<ul style="list-style-type: none"> • Too little driving power • Application limit exceeded (very hard surface) • Unsuitable system 	<ul style="list-style-type: none"> • Try higher power setting or heavier cartridge • Short nail application: Try X-U 15 • Long nail application: Try X-U • Use co-acting principle/ fastener guide • Switch to heavy system like DX 76 PTR
<p>Nail does not hold in base material</p> 	<ul style="list-style-type: none"> • Excess driving energy in thin steel base material (3 to 4 mm steel) 	<ul style="list-style-type: none"> • Try different power setting or different cartridge • Try X-ENP2K or X-EDNK22 THQ 12 for fastening sheet metal
<p>Nail is breaking</p> 	<ul style="list-style-type: none"> • Too little driving power • Application limit exceeded (very hard surface) 	<ul style="list-style-type: none"> • Try higher power setting or heavier cartridge • Use shorter nail • Use X-ENP19 • Use stronger nail (X-...-H) • Use stepped shank nail: X-U 15

DX fastenings on steel

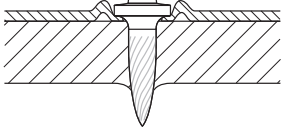
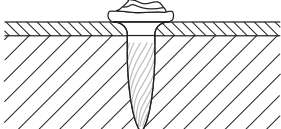
Observation	Cause	Possible remedial measures
<p>Nail head penetrates through material fastened (metal sheet)</p> 	<ul style="list-style-type: none"> • Too much driving power 	<ul style="list-style-type: none"> • Reduce power setting • Use lighter cartridge • Use nail with Top Hat • Use nail with washer e.g. X-U ...S12
<p>Damaged nail head</p> 	<ul style="list-style-type: none"> • Too much driving power • Wrong piston used • Worn-out piston 	<ul style="list-style-type: none"> • Reduce power setting • Use lighter cartridge • Check nail-piston-combination • Change piston

Wrong pistons can cause all the above faults: match pistons to nails!

Fastener	Piston	Piston tip
X-U, X-P, X-S	Use piston X-460-P8	





5. Nail and stud designation

Nail designation

X-C		32	P8 S23 T	
Application:			Washer type X (in mm):	
X-ENP	Siding and Decking Nails		P	Plastic washer e.g. P8 = plastic washer Ø 8
X-ENP2K			S	Steel washer e.g. S36 = steel washer Ø 36
X-HSN	Diaphragm Decking Nails		D	Two washers
NPH	Siding and Decking Nails to Concrete		L	Two domed washers
X-U	Universal Nails		TH	Top Hat
X-P	High Performance Nail for Fastening to Concrete		THQ	Top Hat and high shear washer
X-C	Nails for Concrete and Sand lime-Masonry		MX	Collated for DX tool/ collated fasteners for GX/BX
X-S	Drywall and electrical fasteners to Steel		MXR	Collated for DX 860-ENP
X-EGN	Gas Nails for GX 120		T	For tunneling applications
X-GHP			MXR	Collated for DX 860-ENP
X-GN			T	For tunneling applications
DS	Heavy Duty Nails for Concrete and Steel		B_	For battery tools, e.g. B3
EDS	Heavy Duty Nails for Fastening Steel to Steel		G_	For gas tools, e.g. G3
X-R	Stainless Steel Nail for Fastening to Steel		Dimensions:	
X-CR	Stainless Steel Nails for Concrete, Sand lime Masonry and Steel. And Steel only.		Nail shank length in mm (For details, please refer to product data)	
X-CT	Nails for Forming or other Temporary uses			
DNH	DX-Kwik Nails for Concrete			
X-DKH	(pre-drilled)			

Examples:

X-U 52 P8

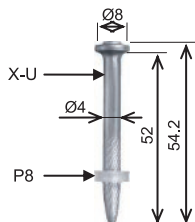

X-U 52 MX

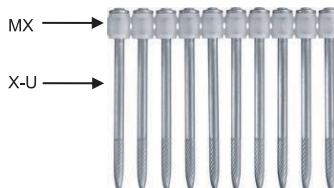

Threaded stud designation

X-M6H		10-37	FP8			
Application:			Washer type and X (in mm):			
X-M6H	DX-Kwik Threaded Studs for Concrete (pre-drilled)		P	Plastic washer e.g. P8 = plastic washer X 8		
X-M8H			S	Steel washer e.g. S8 = steel washer X 8		
X-M6		Threaded Studs for Steel		D	Two washers	
X-W6				F	Plastic guidance sleeve	
X-F7				SN12-R	Stainless steel washer for sealing purposes	
X-M8				B_	For battery tools, e.g. B3	
M10				G_	For gas tools, e.g. G3	
W10						
X-EM6H			Stainless Steel Threaded Studs			
X-EW6H						
X-EF7H						
X-EM8H						
X-EM10H						
X-EW10H						
X-BT	Stainless Steel Threaded Studs for Concrete and Steel					
X-CRM						
X-ST						
			Dimensions:			
			Thread Length and Shank Length in mm			

where M, W, F refer to the thread type:

M	Metric
W	Whitworth
F	French

Examples:

X-BT W10-24-6 SN12-R

X-BT M10-24-6 SN12-R

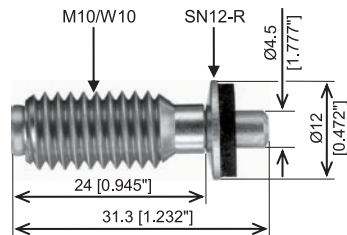

X-BT, X-ST, S-BT Threaded studs designation

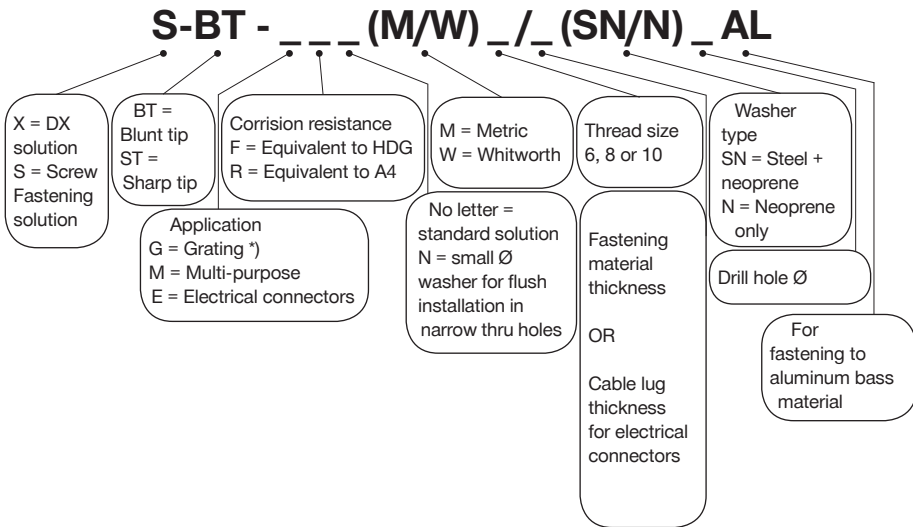

*) X-ST-GR stainless steel threaded studs may also be used for multi-purpose applications.

Examples

- S-BT-MR M10/15 SN 6 AL
- S-BT-GR M8/7 SN 6
- X-BT-MF M10/10 SN 4
- X-BT-ER M8/6 SN 4

Wood nail designation

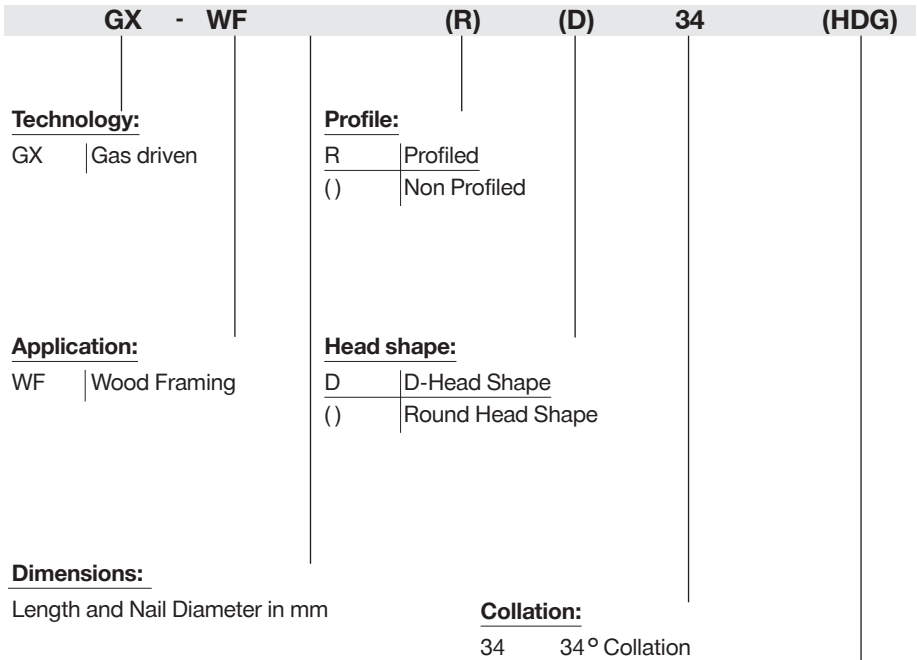

Designation of corrosion protection on the box/label		
Suffix	Type of protection	Service Class (EN 1995-1-1)
“Bright”	no coating	1
“Galv”	12 µm zinc	1, 2
“HDG”	55 µm hot dip galvanized	1, 2, 3
“Stainless”	A2 or A4	1, 2, 3



Part 3:

Tools and equipment



Powder-actuated tool

DX 460-MX Powder-actuated tool for fastening collated nails



Fastener:

X-P __ MX

X-U __ MX

X-C __ MX

X-CT __ MX

X-ET MX

X-ECT MX

X-EKS MX,

X-FB MX

X-HS MX

X-CC MX

X-HS-W MX

X-EKB MX

Piston:

X-5-460-P8

X-5-460-P8W

for fastening wood

Cartridges:

6.8/11M -

black, red, yellow, green

DX 460-F8 Powder-actuated tool for fastening single nails



Fastener:

X-P __ P8

X-U __ P8 / P8 TH

DNH 37 P8S15

X-DKH 48 P8S15

X-C __ P8

X-CR __ P8/ P8S12

X-CR M8

X-CT __ DP8

X-FS, X-SW

X-FB

X-EM6H/EW6H- __ - __ FP8

X-EF7H/- __ - __ FP8

X-M6/W6- __ - __ FP8

F7- __ - __ FP8

X-EM8H- __ - __ P8

X-M8- __ - __ P8

X-HS, X-CC

X-HS-W P8

Piston:

X-5-460-P8

X-5-460-P8W

for fastening wood

Cartridges:

6.8/11M -

black, red, yellow, green

DX-Kwik method:

pre-drilling into concrete

Fastener:

X-M6H-__-37 FP8

X-M8H-__37 P8

X-CRM8-__42 FP8

Piston:

X-5-460-P Kwik

Fastener guide:

X-5-460-F8N15

 Narrow access fastener
guide

(∅ 15.2 mm x 53.2 mm)

Fastener:

X-P __ F8

X-C

X-CR __ P8

X-CRM __ P8

X-ST-GR M8_P8

Piston:

X-5-460-P8

Fastener guide:

X-5-460-F8N10

 Narrow access fastener
guide

(bxdxL 10.4x25.9x50 mm)

Fastener:

X-P __ F8

X-U __ P8

X-C

X-CR __ P8

X-CRM __ P8

Piston:

X-5-460-P8

Fastener guide:

X-5-460-F8GR

Grating fastener guide

Fastener:

X-GR

X-PGR-RU

X-ST-_M8_P8

X-EM 8H

Piston:

X-5-460-PGR

Fastener guide:

X-5-460-F8S12

S12 fastener guide

Fastener:

X-U __ S12

Piston:

X-5-460-P8

Fastener guide:

X-5-460-F8SS

8 mm stop spall fastener
guide



Fastener:

X-M6-__-__FP8

X-W6-__-__FP8

X-F7-__-__FP8

X-M8-__-__P8

Piston:

X-5-460-P8

Fastener guide:

X-5-460-F10



Fastener:

M10 (possible)

Piston:

X-5-460-P10

Fastener guide:

X-5-460-F10SS

10 mm stop spall fastener
guide



Fastener:

M10 (possible)

Piston:

X-5-460-P10

Fastener guide:

X-5-460-FIE-XL



Fastener:

X-IE

Insulation fastener

Piston:

X-5-460-PIE-XL

DX 460-SM Powder-actuated tool for fastening metal decks**Fastener:**

X-EDNK22-THQ12M

X-EDN19-THQ12M

X-HSN 24**Piston:**

X-5-460-PSM**Cartridges:**

6.8/11M –

black, red, yellow

DX 5 MX Digitally enabled powder-actuated tool for fastening collated nails



Fastener:

X-P_MX
 X-U __ MX
 X-C __ MX
 X-CT __ MX
 X-ET_MX
 X-ECT_MX
 X-EKS_MX,
 X-FB_MX
 X-HS_MX
 X-CC_MX
 X-HS-W_MX
 X-EKB_MX

Piston:

X-5-460-P8
 X-5-460-P8W
 for fastening wood

Cartridges:

6.8/11M -
 black, red, yellow, green

DX 5 F8 Digitally enabled powder-actuated tool for fastening single nails



Fastener:

X-P __ P8
 X-U __ P8 / P8 TH
 DNH 37 P8S15
 X-DKH 48 P8S15
 X-C __ P8
 X-CR __ P8/ P8S12
 X-CR M8
 X-R __ P8
 X-ST-GR M8 __ P8
 X-CT __ DP8

X-FS, X-SW
 X-FB
 X-EM6H/EW6H- __ - __ FP8
 X-EF7H/- __ - __ FP8
 X-M6/W6- __ - __ FP8
 F7- __ - __ FP8
 X-EM8H- __ - __ P8
 X-M8- __ - __ P8
 X-HS, X-CC
 X-HS-W_P8

Piston:

X-5-460-P8
 X-5-460-P8W
 for fastening wood

Cartridges:

6.8/11M -
 black, red, yellow, green

DX-Kwik method:

pre-drilling into concrete

Fastener:

X-M6H-__-37 FP8

X-M8H-__37 P8

X-CRM8-__42 FP8

Piston:

X-5-460-P Kwik

Fastener guide:

X-5-460-F8N15

Narrow access fastener
guide

(∅ 15.2 mm x 53.2 mm)

Fastener:

X-P __ F8

X-C

X-CR __ P8

X-CRM __ P8

X-ST-GR M8_P8

Piston:

X-5-460-P8

Fastener guide:

X-5-460-F8N10

Narrow access fastener
guide

(bxdxL 10.4x25.9x50 mm)

Fastener:

X-P __ F8

X-U __ P8

X-C

X-CR __ P8

X-CRM __ P8

Piston:

X-5-460-P8

Fastener guide:

X-5-460-F8GR

Grating fastener guide

Fastener:

X-GR

X-PGR-RU

X-EM 8H

Piston:

X-5-460-PGR

Fastener guide:

X-5-460-F8S12

S12 fastener guide

Fastener:

X-U __ S12

Piston:

X-5-460-P8

Fastener guide:

X-5-460-F8SS

8 mm stop spall fastener
guide



Fastener:

X-M6-__-__FP8

X-W6-__-__FP8

X-F7-__-__FP8

X-M8-__-__P8

Piston:

X-5-460-P8

Fastener guide:

X-5-460-F10



Fastener:

M10 (possible)

Piston:

X-5-460-P10

Fastener guide:

X-5-460-F10

10 mm stop spall fastener
guide



Fastener:

M10 (possible)

Piston:

X-5-460-P10

Fastener guide:

X-5-460-FIE-XL



Fastener:

X-IE

Insulation fastener

Piston:

X-5-460-PIE-XL

DX 5 IE Powder-actuated tool for fastening insulation

Fastener:

X-IE
insulation fasteners

Piston:

X-5-460-PIE-XL

Cartridges:

6.8/11M –
red, yellow, green

DX 5 GR Powder-actuated tool for fastening gratings

Fastener:

X-GR
X-PGR-RU
X-EM 8H

Piston:

X-5-460-PGR

Cartridges:

6.8/11M –
black, red

DX 5 SM Powder-actuated tool for fastening metal decks

Fastener:

X-EDNK22-THQ12M
X-EDN19-THQ12M
X-HSN 24

Piston:

X-5-460-PSM

Cartridges:

6.8/11M –
black, red, yellow

DX 5 F10 Powder-actuated tool for fastening W10 threaded studs

Fastener:

DS_P10
X-EM8H-15-12 FP10
X-EM10H-24-12 P10

Piston:

X-5-460-P10

Cartridges:

6.8/11M –
black, red, yellow, green



DX 351 Powder-actuated tool for interior finishing applications

Fastener:

X-P_MX

X-U_MX

X-C_MX

X-S 13 MX

Piston:

X-P 8S-351

Cartridges:

6.8/11M –
red, yellow, green, white

DX 351-F8 Powder-actuated tool for interior finishing, mechanical and electrical applications

Fastener:

X-P_F8

X-C_P8/TH/THP

X-U15 P8TH

X-CC-U_P8

X-HS __-U_P8S15

Cartridges:

6.8/11M –
red, yellow, green, white

Fastener guide:

X-FG 8L-351

narrow access fastener
guide

Piston:

X-P 8L-351

X-FG 8ME-351

standard fastener guide

Piston:

X-P 8S-351

DX 351-BT Powder-actuated tool for fastening X-BT threaded studs



Fastener:

X-BT M10-24-6 SN12-R
 X-BT M10-24-6-R
 X-BT W10-24-6 SN12-R
 X-BT W10-24-6-R
 X-BT M6-24-6 SN12-R
 X-BT W6-24-6 SN12-R
 X-BT-ER M10/3 SN4
 X-BT-ER W10/3 SN4
 X-BT-ER M8/7 SN4
 X-BT-ER M6/7 SN4
 X-BT-ER W6/7 SN4
 X-BT-MF M/W 10

Piston:

X-351 BT P 1024

Fastener guide:

BT FG M1024 (M10)
 BT FG W1024 (W10)
 Fastener Guide dimensions
 bxdxL = 17.5x22x29.5 mm

Cartridges:

6.8/11M -
 high precision - brown

DX 351-BTG Powder-actuated tool for fastening gratings



Fastener:

X-BT M8-15-6 SN12-R
 X-BT M8-15-6-R

Piston:

X-351 BT P G

Fastener guide:

X-352 BT FG G (M8)
 Fastener Guide dimensions
 bxdxL = 17.5x22x56 mm

Cartridges:

6.8/11M -
 high precision - brown

DX 2 Semi-automatic powder-actuated tool for fastening single nails**Fastener:**

X-P
X-U
X-C
X-CR
X-CT
X-M6/W6/F7/M8
X-FS
X-SW
X-FB
X-DKH
DNH
X-M6H, X-M8H
X-HS
X-CC
X-CRM

Cartridges:

6.8/11M –
red, yellow, green

DX76PTR Powder-actuated tool for fastening metal decks with collated nails



Fastener:
X-ENP-19 L15 MX

Piston:
X-76-P-ENP-PTR

Piston brake:
X-76-PB-PTR

Cartridges:
6.8/18M – black, red, blue

Fastener:
X-ENP2K-20 L15 MX

Piston:
X-76-P-ENP2K-PTR

Piston brake:
X-76-PB-PTR

Cartridges:
6.8/18M – red, blue, green

DX76PTR Powder-actuated tool for fastening metal decks with single nails



Fastener:
X-ENP-19 L15

Piston:
X-76-P-ENP-PTR

Fastener guide:
X-76-F-15-PTR

Piston brake:
X-76-PB-PTR



Cartridges:
6.8/18M – black, red, blue

Fastener:
X-ENP2K-20 L15

Piston:
X-76-P-ENP2K-PTR

Fastener guide:
X-76-F-15-PTR

Piston brake:
X-76-PB-PTR



Cartridges:
6.8/18M – red, blue, green

DX 76 PTR Powder-actuated tool for fastening metal decks on concrete – DX-Kwik

Fastener:

NPH2-42 L15

Piston:

X-76-P-Kwik-PTR

Fastener guide:

X-76-F-Kwik-PTR

Piston brake:

X-76-PB-PTR

Cartridges:

6.8/18M – blue, yellow

DX 76 PTR Powder-actuated tool for fastening HVB shear connectors

Fastener:

X-ENP-21 HVB

Piston:

X-76-P-HVB-PTR

Connector:

X-HVB shear connectors

Piston stop:

X-76-PS

Fastener guide:

X-76-F-HVB-PTR

Cartridges:

6.8/18M – black, red



DX 76 PTR Powder-actuated tool for fastening gratings and checker plates



Grating fastener:

X-CRM8-15-12 P8

X-EM8H_P8

X-ST-GR M8_P8

Chequer plate fastener

X-CRM8-15-12 P8

X-CRM8-9-12 P8

X-ST-GR M8_P8

Fastener guide:

X-76-F-8-GR-PTR

(Δ 19 mm x 58 mm)

Piston:

X-76-P-8-GR-PTR

Piston brake:

X-76-PB-PTR

Cartridges:

6.8/18M –

blue, yellow

For X-GR and X-GRRU:

red, blue, yellow



DX 76 PTR Powder-actuated tool for fastening heavy duty applications



Fastener:

EDS19 – 22 P10

X-EM10H-24-12 P10

X-EM8H-15-12 FP10

X-CR M8-15-12 FP10

X-CR M8-9-12 FP10

DS27 – 37 P10

Fastener guide:

X-76-F-10-PTR

(Δ 19 mm x 58 mm)

Piston:

X-76-P-10-PTR

Piston brake:

X-76-PB-PTR

Cartridges:

6.8/18M –

black, red, blue



DX 76 MX Powder-actuated tool for fastening metal decks with collated nails**Fastener:**X-ENP-19 L15 MX**Piston:**X-76-P-ENP**Cartridges:**6.8/18M – black, red, blue**Fastener:**X-ENP2K-20 L15 MX**Piston:**X-76-P-ENP2K**Cartridges:**6.8/18M –
red, blue, yellow, green**DX 76 F15** fPowder-actuated tool for fastening metal decks with single nails**Fastener:**X-ENP-19 L15**Piston:**X-76-P-ENP**Cartridges:**6.8/18M – black, red, blue**Fastener:**X-ENP2K-20 L15**Piston:**X-76-P-ENP2K**Cartridges:**6.8/18M –
red, blue, yellow, green

DX 76 F15 Powder-actuated tool for fastening metal decks on concrete – DX-Kwik



Fastener:
NPH2-42 L15

Piston:
X-76-P-Kwik

Fastener guide:
X-76-F-Kwik

Cartridges:
6.8/18M – blue, yellow

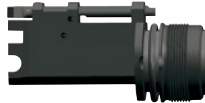

DX 76 F15 Powder-actuated tool for fastening HVB shear connectors



Fastener:
X-ENP-21 HVB

Piston:
X-76-P-HVB

Connector:
X-HVB shear connectors

Piston Stop:
X-76-PS

Fastener guide:
X-76-F-HVB

Cartridges:
6.8/18M – black, red



DX 76 F15 Powder-actuated tool for fastening gratings and checker plates

Grating fastener:

X-CRM8-15-12 FP10

X-EM8-15-12 FP10

Piston:

X-76-P-GR

Checker plate fastener

X-CRM8-15-12 FP10

X-CRM8-9-12 FP10

Cartridges:

6.8/18M –
black, red, blue, yellow,
green

Fastener guide:

X-76-F-10

DX 76 F15 Powder-actuated tool for fastening heavy duty applications

Fastener: (for nail)

EDS 19 – 27 P10

Piston: (for nail)

X-76-P-10

Fastener: (for stud)

X-EM10-24-14 P10

Piston: (for stud)

X-76-P-GR

Fastener guide:

X-76-F-10
for nails and studs

Cartridges:

6.8/18M –
black, red, blue, yellow,
green

DX 860-ENP Powder-actuated tool for fastening metal decks



Fastener:
X-ENP-19 L15 MXR

Piston:
X-76-P-ENP

Cartridges:
6.8/18M40 –
black, red, blue

DX 860-HSN Powder-actuated tool for fastening metal decks



Fastener:
X-EDNK22-THQ12M
X-EDN19-THQ12M
X-HSN 24

Piston:
X-860-P10

Cartridges:
6.8/11M40 –
black, red, yellow

DX 9-ENP Digitally enabled powder-actuated tool for fastening metal decks

Fastener:

X-ENP-19 L15 MXR

Piston:

Piston X-9-ENP kit

Nail Magazine:

MX 9 - ENP packed

Cartridges:

 6.8/18M40 -
black, red, blue

DX 9-HSN Digitally enabled powder-actuated tool for fastening metal decks

Fastener:

X-EDNK22-THQ12M

X-EDN19-THQ12M

X-HSN 24

Piston:

X-9-HSN kit

Cartridges:

 6.8/11M40 -
black, red, yellow

Nail Magazine:

MX 9 - HSN packed

Cartridges – Propellants for powder-actuated tools

Cartridge 6.8/11M10 and 6.8/11M40¹ (.27 caliber short)



Color code*	Power level**	Fastening tools:			
		DX 36, DX 2	DX 460 DX 5	DX 351	DX 860-HSN ¹ DX 9-HSN ¹
High precision brown	2 [2]	no	no	4	no
white [brown]	2 [2]	no	no	4	no
green	3 [3]	4	4	4	no
yellow	4 [4]	4	4	4	4
red	6 [5]	4	4	4	4
black [purple]	7 [6]	no	4	no	4

Cartridge 6.8/18M10 (.27 caliber long)



Color code*	Power level**	Fastening tools:
		DX 76 / DX 76 PTR
green	3	4
yellow	4	4
blue	5 [4.5]	4
red	6 [5]	4
black [purple]	7 [6]	4

Cartridge 6.8/18M40 (.27 caliber long)



Color code*	Power level**	Fastening tools:
		DX 860-ENP, DX 9-ENP
blue	5 [4.5]	4
red	6 [5]	4
black [purple]	7 [6]	4

6.8/18 (.27 caliber long)¹



Color code*	Power level**	Fastening tools:
		DX 600N ¹
green	3	4
yellow	4	4
red	5	4
black [purple]	7 [6]	4

* Color code according to EN16264, in brackets e.g. [purple] according to PATMI (USA and Canada)

** Power level as used on Hilti packaging. Without brackets refers to level used in Europe, in brackets e.g. [6] refers to number according to PATMI and as used in USA and Canada.

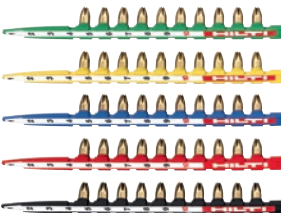

The Clean-Tec cartridges is Hilti's line of environmentally-friendly heavy metal free cartridges. All cartridges are available as Clean Tec except for 6.8/18 (.27 calibre long) for DX 600N tool.

Gas-actuated tool

GX 90 WF Gas-actuated tool for wood framing



Fastener:

- GX-WF _____
smooth bright MX 34
- GX-WF _____
profiled bright MX 34
- GX-WF _____
smooth galvanized MX 34
- GX-WF _____
profiled galvanized MX 34
- GX-WF _____
smooth HDG MX 34
- GX-WF _____
profiled HDG MX 34
- GX-WF _____
profiled A2 stainless D-head

- GX-WF _____
profiled A2 stainless full
round head
- GX-WF _____
profiled A4 stainless D-head
- GX-WF _____
profiled A4 stainless full
round head

Energy:

GC 32



GX 120 Gas-actuated tool for interior finishing applications



Fastener:

X-EGN 14 MX
 X-GHP 16 MX
 X-GHP 17 MX
 X-GHP 20 MX
 X-GHP 24 MX
 X-GN 20 MX
 X-GN 27 MX
 X-GN 32 MX
 X-GN 39 MX

Energy:

GC20. GC 21 and GC 22



GX 120-ME Gas-actuated tool for mechanical and electrical applications



Fastener:

X-EGN 14 MX
 X-GHP 16 MX
 X-GHP 17 MX
 X-GHP 20 MX
 X-GHP 24 MX
 X-GN 20 MX
 X-GN 27 MX
 X-GN 32 MX
 X-GN 39 MX
 X-EHS MX
 X-ECC MX
 X-HS-W MX
 X-EKB MX
 X-FB MX
 X-DFB MX
 X-ECT MX
 X-ET MX
 X-EKS MX
 X-EMTSC
 X-G M6/W6
 X-UCT MX
 X-SW 30, X-SW 60

Energy:

GC20. GC 21 and GC 22



GX 3 Gas-actuated tool for interior finishing and building construction applications

Fastener:

- _____ X-S 14 G3 MX
- _____ X-P 17 G3 MX
- _____ X-P 20 G3 MX
- _____ X-P 24 G3 MX
- _____ X-C 20 G3 MX
- _____ X-C 27 G3 MX
- _____ X-C 32 G3 MX
- _____ X-C 39 G3 MX
- _____ X-M6-7-14 G3 P7
- _____ X-M6-7-24 G3 P7
- _____ X-W6-12-20 G3 P7
- _____ X-W6-12-14 G3 P7

Energy:

- _____ GC42 for international
- _____  GC41 for use in
North America
- _____ GC40 for use in Japan

GX 3-ME Gas-actuated tool for mechanical and electrical applications

Fastener:

- _____ X-S 14 G3 MX
- _____ X-P 17 G3 MX
- _____ X-P 20 G3 MX
- _____ X-P 24 G3 MX
- _____ X-C 20 G3 MX
- _____ X-C 27 G3 MX
- _____ X-C 32 G3 MX
- _____ X-C 39 G3 MX
- _____ X-M6-7-14 G3 P7
- _____ X-M6-7-24 G3 P7
- _____ X-W6-12-20 G3 P7
- _____ X-W6-12-14 G3 P7

Energy:

- _____ GC42 for international
- _____  GC41 for use in
North America
- _____ GC40 for use in Japan

GX 2 Gas-actuated tool for interior finishing and building construction applications



Fastener:

- X-P 14 G2 MX
- X-P 17 G2 MX
- X-P 20 G2 MX
- X-C 20 G2 MX
- X-C 27 G2 MX
- X-C 32 G2 MX
- X-C 39 G2 MX





Energy:

GC52



Gas cans

The table below provides an overview of the main Hilti gas cans and their characteristics.

Model	Number of fastenings per can	Temperature range		Fuel gauge	Tool to be used with
GC 21	750	-5°C - +50°C		Yes	GX 120
GC 22	750	-10°C - +50°C		Yes	GX 120
GC 32	1000	-10°C - +50°C		No	GX 90 - WF
GC 42	1200	-10°C - +50°C		Yes	GX 3
GC 52	1100	-10°C - +50°C		Yes	GX 2

Note: The models sold in North America and Japan have slightly different characteristics.

Battery-actuated tool

BX 3-BT Battery-actuated tool for multi-purpose and electrical connection applications



Fastener:

X-BT-MR M6/10 SN 8
 X-BT-MR W6/10 SN 8
 X-BT-MR M8/14 N 8
 X-BT-MR M10/15 SN 8
 X-BT-MR W10/15 SN 8
 X-BT-ER M6/3 SN 8
 X-BT-ER W6/3 SN 8
 X-BT-ER M8/7 SN 8
 X-BT-ER M10/7 SN 8
 X-BT-ER W10/7 SN 8
 X-BT M10-24-6 SN12-R
 X-BT M10-24-6-R
 X-BT W10-24-6 SN12-R
 X-BT W10-24-6-R
 X-BT-ER M10/3 SN4
 X-BT-ER W10/3 SN4
 X-BT-ER M8/7 SN4

Energy:

Battery

Fastener Guide:

X-FG B3-BT M (M6/M8/M10)
 X-FG B3-BT W (W6/W10)

BX 3-BTG Battery-actuated tool for fastening gratings



Fastener:

X-BT-GR M8/7 SN 8
 X-BT M8-15-6 SN12-R

Energy:

Battery

Fastener Guide:

X-FG B3-BTG (M8 short)

BX 3-IF Battery-actuated tool for interior finishing and building construction applications



Fastener:

X-S 14 B3 MX
 X-P 17 B3 MX
 X-P 20 B3 MX
 X-P 24 B3 MX
 X-C 20 B3 MX
 X-C 24 B3 MX
 X-C 30 B3 P7
 X-C 36 B3 P7
 X-M6-7-14 B3 P7
 X-M6-7-24 B3 P7
 X-W6-12-20 B3 P7
 X-W6-12-14 B3 P7

Energy:

Battery

BX 3-ME Battery-actuated tool for mechanical and electrical applications



Fastener:

X-S 14 B3 MX
 X-P 17 B3 MX
 X-P 20 B3 MX
 X-P 24 B3 MX
 X-P 30 B3 P7
 X-P 36 B3 P7
 X-C 20 B3 MX
 X-C 24 B3 MX
 X-M6-7-24 B3 P7
 X-M6-7-14 B3 P7
 X-W6-12-20 B3 P7
 X-W6-12-14 B3 P7
 X-EHS MX
 X-ECC MC
 X-HS-W MX
 X-EKB MX

X-FB MX
 X-DFB MX
 X-ECT MX
 X-ET MX
 X-EKS MX
 X-EMTSC MC
 X-ECH MX
 X-UCT MX
 X-DHS MX
 X-ECH FE MX
 X-EKB FE MX
 X-SW MX

Energy:

Battery

BX 3 02 Battery-actuated tool for mechanical and electrical applications

Fastener:

X-S 14 B3 MX

X-P 17 B3 MX

X-P 20 B3 MX

X-P 24 B3 MX

X-C 20 B3 MX

X-C 24 B3 MX

X-C 30 B3 MX

X-EHS MX

X-ECC MC

X-HS-W MX

X-EKB MX

X-FB MX

X-DFB MX

X-ECT MX

X-ET MX

X-EKS MX

X-EMTSC MC

X-ECH MX

X-UCT MX

X-DHS MX

X-ECH FE MX

X-EKB FE MX

X-SW MX

Energy:

Battery

BX 3-L 02 Battery-actuated tool for interior finishing, mechanical and electrical and building construction applications

Fastener:

X-S 14 B3 MX

X-P 17 B3 MX

X-P 20 B3 MX

X-P 24 B3 MX

X-C 20 B3 MX

X-C 24 B3 MX

X-C 30 B3 MX

X-C 36 B3 MX

X-EHS MX

X-ECC MC

X-HS-W MX

X-EKB MX

X-FB MX

X-DFB MX

X-ECT MX

X-ET MX

X-EKS MX

X-EMTSC MC

X-ECH MX

X-UCT MX

X-DHS MX

X-ECH FE MX

X-EKB FE MX

X-SW MX

Energy:

Battery

Part 4:

Fasteners

X-ENP Siding and decking nail

Product data

Dimensions

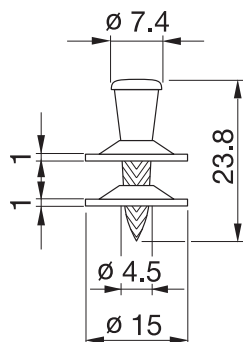

General information

Material specifications

Carbon steel shank:	HRC 58
Zinc coating:	8–16 µm

Recommended fastening tools

DX 76 F15, DX 76 PTR with X-76-F15-PTR fastener guide	Single nail: X-ENP-19 L15
DX 76 MX, DX 76 PTR	Collated nails: X-ENP-19 L15 MX, white magazine strip
DX 860-ENP DX 9-ENP	X-ENP-19 L15 MXR, grey magazine strip

See **Tools and equipment** for more details.

Approvals

ETA-04/0101 (Hilti-DX-DoP001), UL R13203, FM 3021719, ICC ESR-2197, ESR-2776 (USA), MLIT (Japan), ABS, LR 97/00077

Applications

Examples

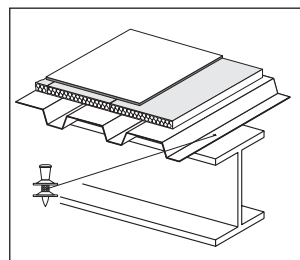

Roof decking

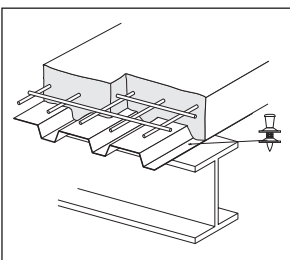

Floor decking

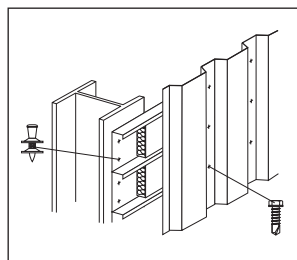

Wall liners

The intended use only comprises fastenings which are not directly exposed to external weather conditions or moist atmospheres. For out-door applications, that can be ensured by using SDK2 sealing caps. During construction exposure to external atmosphere must not exceed 6 months. Fastening of aluminum sheeting is generally recommended only for indoor conditions.

Load data

Characteristic loads – steel sheeting

Sheeting thickness t_f [mm]	Trapezoidal profile (symmetric loading)		Liner trays ¹⁾ (asymmetric loading)	
	Char. resistance according to ETA-04/0101		Char. resistance keeping to ETA-04/0101	
nominal	Shear V_{Rk} [kN]	Tension N_{Rk} [kN]	Shear V_{Rk} [kN]	Tension N_{Rk} [kN]
0.75	4.70	6.30	3.30	4.40
0.88	5.40	7.20	3.80	5.00
1.00	6.00	8.00	4.20	5.60
1.13	7.00	8.40	4.90	5.90
1.25	8.00	8.80	5.60	6.20
1.50	8.60	8.80	6.00	6.20
1.75	8.60	8.80	6.00	6.20
2.00	8.60	8.80	6.00	6.20
2.50	8.60	8.80	6.00	6.20

• N_{Rk} and V_{Rk} are valid for steel sheet with minimum tensile strength ≥ 360 N/mm² (\geq S280 EN 10346).

• For intermediate sheet thicknesses, use recommended load for next smaller thickness or linear interpolation.

1) Required load reduction is taken into account in accordance with EN 1993-1-3: 2006, section 8.3 (7) and fig. 8.2. See also construction rules under spacings and edge distances.

Recommended loads – steel sheeting

Sheeting thickness t_f [mm]	Trapezoidal profile (symmetric loading)		Liner trays ¹⁾ (asymmetric loading)	
	Recommended loads		Recommended loads	
nominal	Shear V_{rec} [kN]	Tension N_{rec} [kN]	Shear V_{rec} [kN]	Tension N_{rec} [kN]
0.75	2.50	3.35	1.75	2.35
0.88	2.90	3.85	2.00	2.70
1.00	3.20	4.25	2.25	3.00
1.13	3.75	4.50	2.65	3.15
1.25	4.25	4.70	3.00	3.30
1.50	4.60	4.70	3.20	3.30
1.75	4.60	4.70	3.20	3.30
2.00	4.60	4.70	3.20	3.30
2.50	4.60	4.70	3.20	3.30

• N_{rec} and V_{rec} are valid for steel sheet with minimum tensile strength ≥ 360 N/mm² (\geq S280 EN 10346).

• For intermediate sheet thicknesses, use recommended load for next smaller thickness or linear interpolation.

• Recommended loads N_{rec} and V_{rec} are appropriate for Eurocode 1 wind loading design with a partial safety factor $\gamma_F = 1.5$ for wind load and a partial resistance factor $\gamma_M = 1.25$ for the fastening.

1) Required load reduction is taken into account in accordance with EN 1993-1-3: 2006, section 8.3 (7) and fig. 8.2. See also construction rules under spacings and edge distances.

Recommended loads – aluminum sheeting¹⁾ with $f_u \geq 210 \text{ N/mm}^2$

Trapezoidal profile (symmetric loading)

Thickness t_f [mm]	Shear V_{rec} [kN]	Tension N_{rec} [kN]
0.60	0.75	0.35
0.70	0.90	0.50
0.80	1.00	0.65
0.90	1.20	0.80
1.00	1.30	0.95
1.20	1.55	1.30
1.50	1.85	1.45
2.00	2.55	1.90

- 1) Only recommended for indoor applications. Constraint forces and corrosion aspects have to be considered.
- For intermediate sheet thicknesses, use recommended load for next smaller thickness.
 - Recommended loads N_{rec} and V_{rec} are appropriate for Eurocode 1 wind loading design with a partial safety factor of $\gamma_F = 1.5$ for wind load and a partial resistance factor $\gamma_M = 1.25$ for the fastening.

Recommended loads – other applications

	V_{rec} [kN]	N_{rec} [kN]
	4.6	2.4

- **Fastened parts:** clips, brackets, etc.; thick steel parts ($t_{i,max} = 2.5 \text{ mm}$).
- Redundancy (multiple fastening) must be provided.
- The possibility of prying effects has to be considered
- Failure of the fastened part is not considered in these values of N_{rec} , V_{rec} .
- Valid for predominantly static loading
- Global factor of safety is ≥ 2 based on 5% fracture value

Design

Depending on the verification concept, the corresponding design criteria are given as following.

Working load concept	Partial safety concept
Tensile loads $N_{Sk} \leq N_{rec}$	$N_{Sd} \leq N_{Rd}$
Shear loads $V_{Sk} \leq V_{rec}$	$V_{Sd} \leq V_{Rd}$

N-V Interaction

For combined tensile and shear forces on the fastener, a linear function has to be used.

$$\left(\frac{V_{Sk}}{V_{rec}}\right) + \left(\frac{N_{Sk}}{N_{rec}}\right) \leq 1$$

with:

 V_{Sk} , N_{Sk} unfactored characteristic load acting on the fastening (= working load)

 V_{rec} , N_{rec} recommended (allowable) load with $\gamma_{LOB} = 1.875$

$$\left(\frac{V_{Sd}}{V_{Rd}}\right) + \left(\frac{N_{Sd}}{N_{Rd}}\right) \leq 1$$

with:

 V_{Sd} , N_{Sd} Design load with $\gamma_F = 1.5$
 V_{Rd} , N_{Rd} Design resistance of the fastening with $\gamma_M = 1.25$
 $V_{Rd} = V_{Rk} / 1.25$
 $N_{Rd} = \alpha_{cycl} N_{Rk} / 1.25$
 $\alpha_{cycl} = 1.0$ according to ETA-04/0101

Application requirements

Thickness of base material

Steel thickness t_{II}

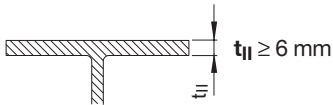

Thickness of fastened material

$\Sigma t_{i, \text{tot}} \leq 4.0 \text{ mm}$

Sheet thicknesses and overlap types

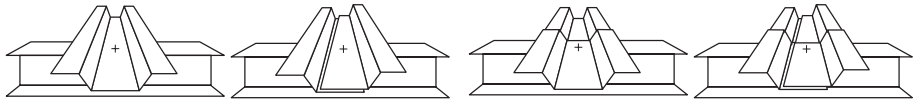

(a)
single

(b)
side lap

(c)
end overlap

(d)
side lap and end overlap

Nominal sheeting thickness t_i [mm]

Allowable overlap types

0.63–1.00

a, b, c, d

> 1.00–1.25

a, c

> 1.25–2.50

a

With the above recommended sheet thickness and overlap types, it is not necessary to take into account the effect of constraints due to temperature for steel grades up to S320 (EN 10346). For steel grade S350 (EN 10346) it shall be considered for design. Sheets of grade S350 on base material $t_{II} \geq 8 \text{ mm}$ have been verified by Hilti, forces of constraint can be neglected.

Spacing and edge distances (mm)

Steel base material



Trapezoidal profiles

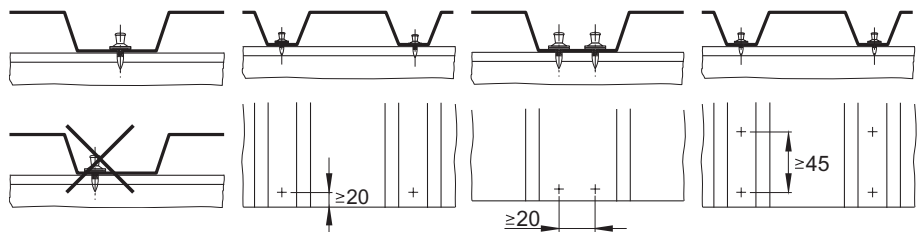

Centre fastenings in ribs

Clearance to end of sheet

Double fastenings (asymmetric)
 Note:
 Reduce tensile resistance per fastener to 0.7 N_{Rk} or 0.7 N_{rec}.

Liner trays

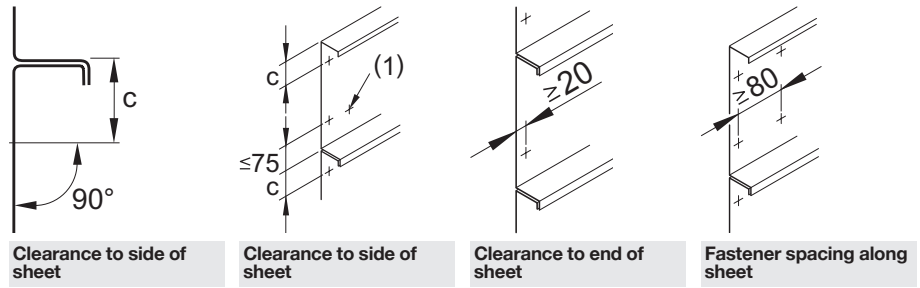

Clearance to side of sheet

Clearance to side of sheet

Clearance to end of sheet

Fastener spacing along sheet

When driving the fastener, the fastening tool needs to be positioned perpendicular to the surface.
 If $c > 75$ mm, it is recommended to drive an additional fastener at the other side of the tray. This additional fastener is indicated with (1) in the graph above.

Corrosion information

The intended use only comprises fastenings which are not directly exposed to external weather conditions or moist atmospheres. For outdoor applications that can be ensured by using **SDK 2** sealing caps. During construction exposure to external atmosphere must not exceed 6 months. Fastening of aluminum sheeting is generally recommended only for indoor conditions.

Application limit

X-ENP-19 with DX 76, DX 76 PTR, DX 860-ENP and DX 9-ENP

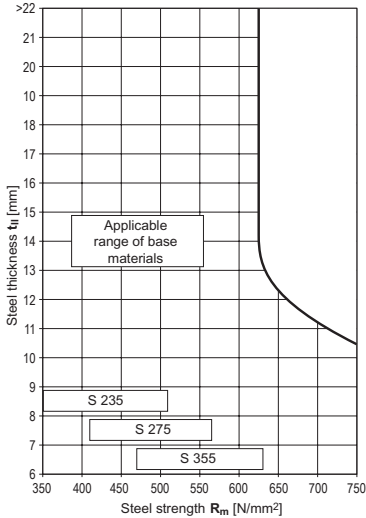

Fastener selection and system recommendation

Fasteners			Tools	Fastener guide
	Designation	Item no.	Designation	Designation
Single nail:	X-ENP-19 L15	283506	DX 76 PTR DX 76 F15	X-76-F15-PTR
Collated nails:	X-ENP-19 L15 MX, white magazine strip	283507	DX 76 PTR DX 76 MX	
	X-ENP-19 L15 MXR, grey magazine strip	283508	DX 860-ENP	
Piston:	X-76-P-ENP-PTR		DX 76 PTR	
	X-76-P-ENP		DX 76 DX 860-ENP	
	X-9-ENP kit		DX 9-ENP	

Cartridge selection and tool energy setting

DX 76, DX 860-ENP, DX 9-ENP

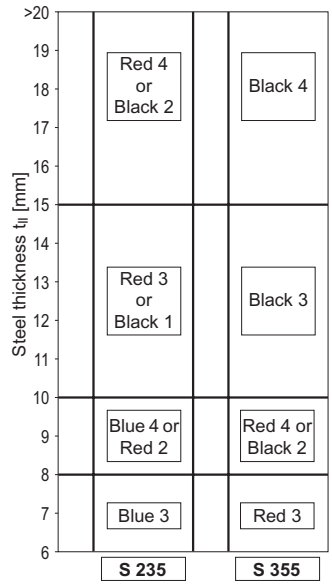

DX 76 PTR

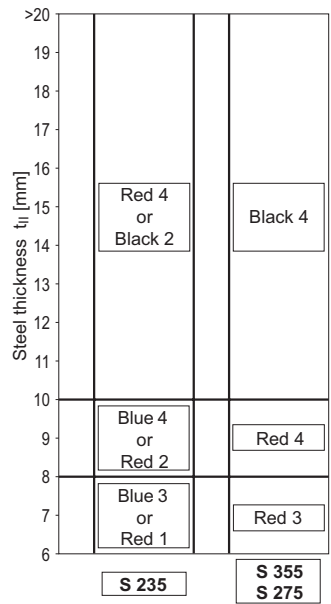

Fine adjustment by installation tests on site.

Note for S275:

Start with recommendation for S355. In case of too much energy: reduction of tool energy setting or change of cartridge colour till correct nail head stand-offs h_{NVS} are achieved.

Fastening quality assurance

Fastening inspection

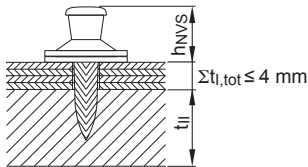

$h_{NVS} = 8.2-9.8 \text{ mm}$ for $t_{i,tot} \leq 4 \text{ mm}$

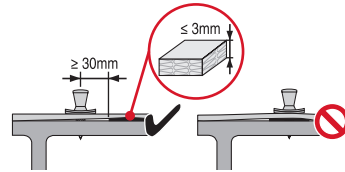

In order to allow the steel sheeting to be in direct contact with the steel supporting structure in the area of connections the X-ENP-19 fastener should be installed $\geq 30\text{mm}$ away from the edges of insulation / isolation tapes that are $\leq 3\text{mm}$ thick.

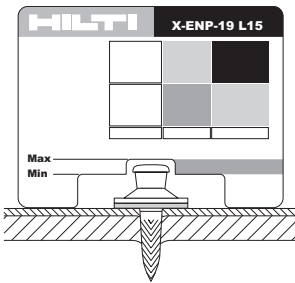

$h_{NVS} = 8.2-9.8 \text{ mm}$

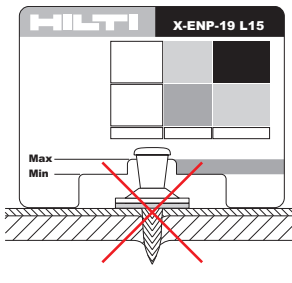

$h_{NVS} > 9.8 \text{ mm}$
(washers are not compressed)

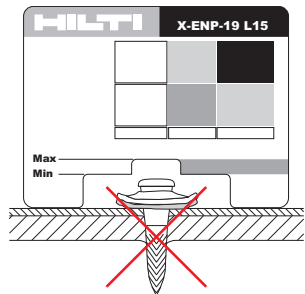

$h_{NVS} < 8.2 \text{ mm}$
(washers are strongly damaged by the tool piston)



Visible inspection:
Properly driven fastener.
Piston mark clearly visible on the washer.

SDK2, PDK2 Sealing cap for cladding fastening

Product data

Dimensions

SDK2 sealing cap

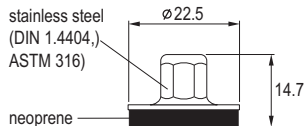

PDK2

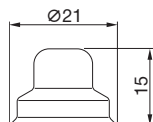

General information

Compatible DX fasteners

X-ENP-19 L15

Base material thickness $t_{ij} \geq 6$ mm

Fastening tool

SW/SDK2 setting tool **SDK2**

SW/PDK2 setting tool **PDK2**

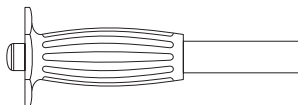

Applications

Examples

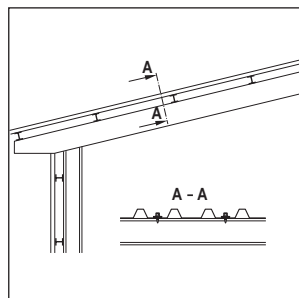

Roof and wall cladding on single skin buildings

SDK2, stainless steel sealing cap for roof and wall cladding

Stainless steel cap for mildly corrosive environments (C3)

Space under the cap isolated from the atmosphere

Neoprene washer insulates against contact corrosion and seals the space under the cap-off from the atmosphere

Pressure on the washer seals the gap between the sheet and the base steel

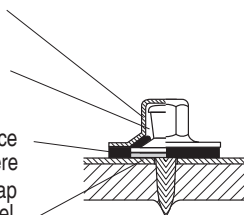

PDK2, plastic sealing cap for wall cladding

Corrosion protection

Fastening quality assurance
Fastening inspection

For detailed information on X-ENP-19 L15 please see the according product pages.

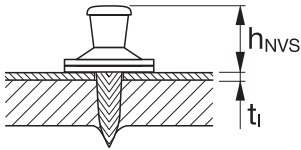
X-ENP-19 L15

h_{NVS} Maximum thickness of single layer (type a):
 $t_{i, \max} = 1.5 \text{ mm}$
 Total thickness of end overlap (type c):
 $\Sigma t_{i, \text{tot}} \leq 2.5 \text{ mm}$

 $h_{NVS} = 8.2\text{--}9.8 \text{ mm}$

Note:

It has to be ensured, that the fastened sheet is properly compressed to the base material and no gap remains at fastening point location.

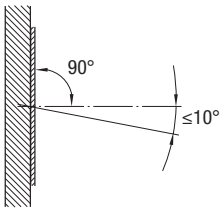
Installation

Position the DX tool so that nail inclination is limited to max. 10° from perpendicular to surface

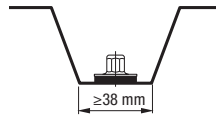
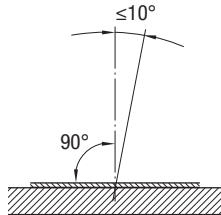

Centre fastening in valley.
 38 mm min. valley width

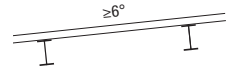

Minimum roof slope 6°

These are abbreviated instructions which may vary by application.

ALWAYS review/follow the instructions accompanying the product.

X-ENP 2K Siding and decking nail

Product data

Dimensions

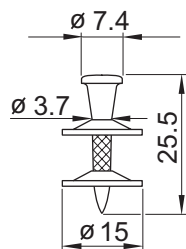

General information

Material specifications

Carbon steel shank:	HRC 55.5
Zinc coating:	8–16 μm

Recommended fastening tools

	Single nail:
DX 76 PTR with X-76-F-15-PTR fastener guide	X-ENP 2K-20 L15
DX 76 MX with X-76-F-15 fastener guide	

	Collated nails:
DX 76 PTR	X-ENP 2K-20 L15 MX
DX 76 MX	(green magazine strip)

See **Tools and equipment** for more details.

Approvals

BUtgb (Belgium), ABS, ETA 13/0172
(Hilti-DX-DoP003),
LR 97/00077



Note: technical data presented in these approvals and design guidelines reflect specific local conditions and may differ from those published in this handbook.

Applications

Examples

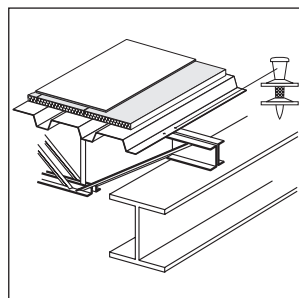

Roof and floor decking

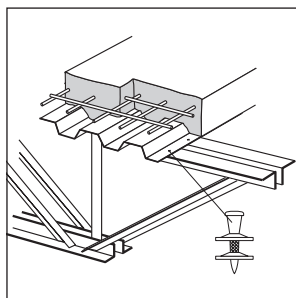

Roof and floor decking

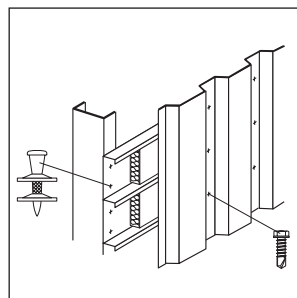

Wall liners

Load data

Characteristic loads

Overlap Sheeting thickness t_{II} [mm]	$3 \text{ mm} \leq t_{II} < 4 \text{ mm}$			$4 \text{ mm} \leq t_{II} \leq 6 \text{ mm}$		
	V_{Rk} [kN]	N_{Rk} [kN]	Types of conn.	V_{Rk} [kN]	N_{Rk} [kN]	Types of conn.
0.75	4.70	6.00	a, c	4.70	6.30	a, b, c, d
0.88	5.40	6.00	a, c	5.40	7.20	a, (b)*, c, d
1.00	6.00	6.00	a, c	6.00	8.00	a, (b)*, c, d
1.13	–	–	–	7.00	8.40	a, c
1.25	–	–	–	8.00	8.80	a, c
1.50	–	–	–	8.60	8.80	a

* Fastening type (b) covered for $5 \text{ mm} \leq t_{II} < 6 \text{ mm}$, if N_{Rk} is reduced to 6.6 kN

Fastening type (b) fully covered for $t_{II} = 6 \text{ mm}$

For a, b, c, d please refer to **Application requirements, Sheet thicknesses and overlap types**

Design

Design shear and tension resistance V_{Rd} and N_{Rd}

$$V_{Rd} = V_{Rk} / \gamma_M \quad N_{Rd} = \alpha_{cycl} V_{Rk} / \gamma_M \text{ with } \alpha_{cycl} = 1.0 \text{ for all sheeting thickness } t_{II}$$

α_{cycl} considers the effect of repeated wind loads

$\gamma_M = 1.25$ in the absence of national regulations

Characteristic tension resistances n_{Rk} [kN/m] and shear resistances v_{Rk} [kN/m] per unit length, taking the effect of thermal constraints into account

N_{Rk} and V_{Rk} characteristic shear and tension resistance

w ... width of the panel sheet

$$n_{Rk} = 0.9 \cdot 2 \cdot N_{Rk} / w \quad v_{Rk} = 2 \cdot V_{Rk} / w$$

$$n_{Rk} = 0.9 \cdot 3 \cdot N_{Rk} / w \quad v_{Rk} = 3 \cdot V_{Rk} / w$$

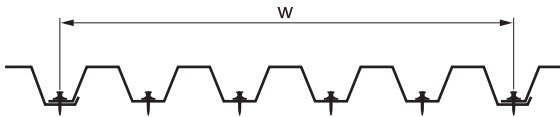

$$n_{Rk} = 0.9 \cdot 4 \cdot N_{Rk} / w \quad V_{Rk} = 4 \cdot V_{Rk} / w$$

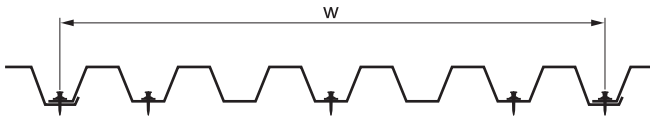

$$n_{Rk} = 0.9 \cdot 5 \cdot N_{Rk} / w \quad V_{Rk} = 5 \cdot V_{Rk} / w$$

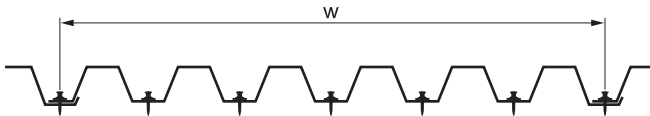

$$n_{Rk} = 3 \cdot N_{Rk} / w \quad V_{Rk} = 3 \cdot V_{Rk} / w$$

The same characteristic resistances can also be applied along supports at end-overlaps, if connection type “d” is not covered in the load table.

Application requirements

Thickness of base material

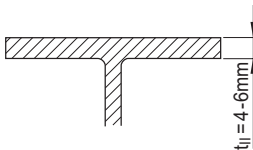

$t_{II} = 4.0 - 6.0$ mm for general shapes

Fastening to cold-formed C- and Z-sections with a thickness from 2.9 to 4.0 mm

Fastening to U-shape concrete inlays with a nominal thickness t_{II} of 3 mm.
 $t_{II} = 3.0 \pm 0.3$ mm

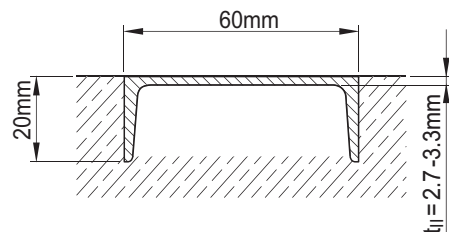
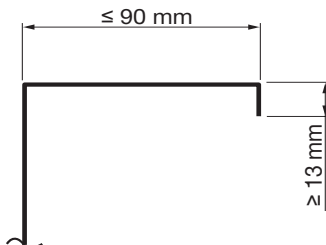

Grade: \ge S320 GD according to EN 10346

Sheet thicknesses and overlap types

Type (a)

single

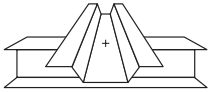

Type (b)

side lap

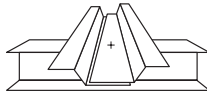

Type (c)

end overlap

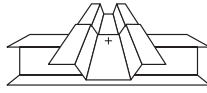

Type (d)

side lap and end overlap

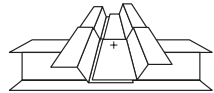

Edge distances (mm)

Rolled I or wide flange shapes

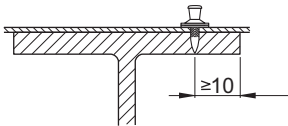

Angles

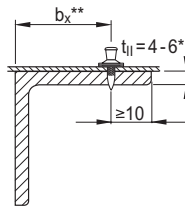

* For $t_{fl} = 3$ to 4 mm, restrictions on application. See approval or contact Hilti.

** Maximum recommended $b_x \leq 8 \times t_{fl}$ however, jobsite verification advisable.

Trapezoidal profiles

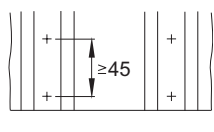
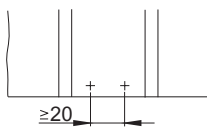
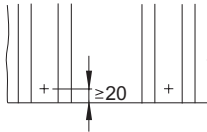
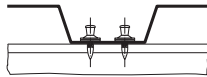
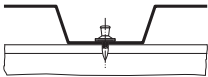

Centre fastenings in ribs

Clearance to end of sheet

Double fastenings

Note:
Reduce tensile resistance per fastener to $0.7 N_{Rk}$.

Corrosion information

The intended use only comprises fastenings which are not directly exposed to external weather conditions or moist atmospheres. For further detailed information on corrosion see corresponding chapter in **Direct Fastening Principles and Technique** section.

Application limits

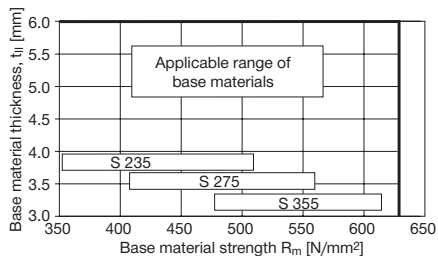

Fastener selection and system recommendation

Fasteners			Tools	Fastener guide
	Designation	Item no.	Designation	Designation
Single nail:	X-ENP 2K-20 L15	385133	DX 76 PTR	X-76-F-15-PTR
			DX 76 MX	X-76-F-15
Collated nails:	X-ENP 2K-20 L15 MX	385134	DX 76 PTR	
			DX 76 MX	
Piston:	X-76-P-ENP2K-PTR		DX 76 PTR	
	X-76-P-ENP2K		DX 76 MX	

Cartridge selection and tool energy setting

DX 76 PTR

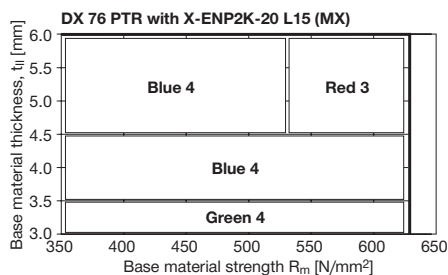

DX 76

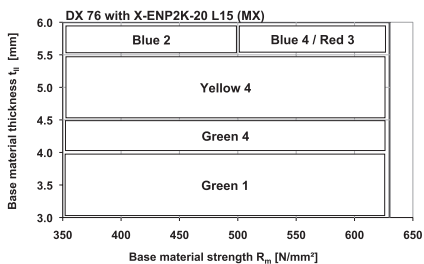

Fine adjustment by installation tests on site.

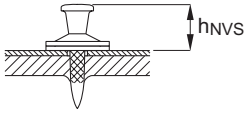
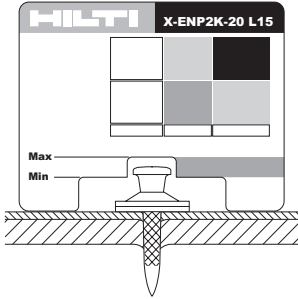
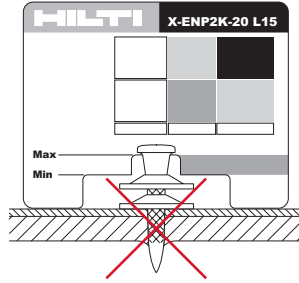
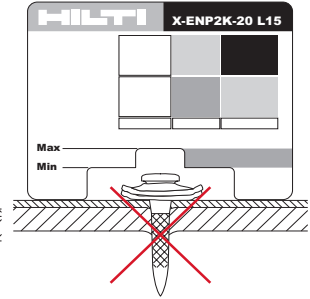
Fastening quality assurance $h_{NVS} = 7-11 \text{ mm}$  $h_{NVS} = 7-11 \text{ mm}$  $h_{NVS} > 11 \text{ mm}$  $h_{NVS} < 7 \text{ mm}$

X-HSN 24 Diaphragm decking nail

Product data

Dimensions

X-HSN 24

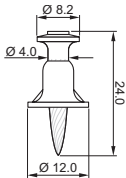

X-EDNK22 THQ12 M

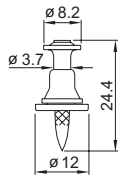

X-EDN19 THQ12 M

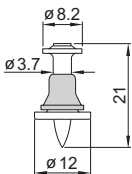

General information

Material specifications

Carbon steel shank:	HRC 55.5
Zinc coating:	5–13 μm

Recommended fastening tool

DX 860-HSN	Collated nails:
DX 9-HSN	X-HSN 24, red magazine strip X-EDNK22 THQ12 M, grey magazine strip X-EDN19 THQ12 M, white magazine strip

See **Tools and equipment** for more details.

Approvals

FM, SDI, UL, ICC, ABS, LR

Note:

Technical data presented in these approvals and design guidelines effect specific local conditions and may differ from those published in this handbook.

Applications

Examples

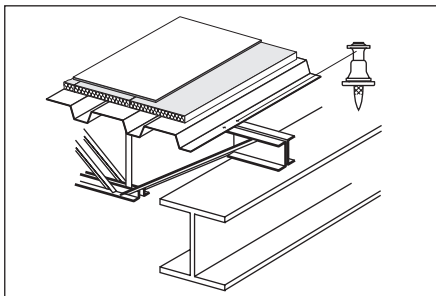

Roof decking (diaphragm design)

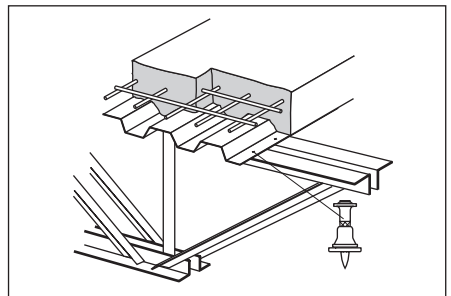

Floor decking (diaphragm design)

Load data
Design data for use in the U.S.A.
Diaphragm strength

Approvals provide load tables or calculation procedures for determination of the allowable strength (in lbs/ft or kN/m) of a steel deck diaphragm. The allowable diaphragm strength depends on the type, strength and thickness of the decking, the span of the decking, the type and pattern of the deck to frame fasteners (X-HSN24, X-EDNK22 or X-EDN19) and the type and spacing of the sidelap connectors (e.g. Hilti sidelap connectors S-SLC 01 and S-SLC 02).

For more details it is referred to the technical literature of Hilti North America (“Steel Deck Fastening Systems” Hilti North America Product Technical Guide) and the “Decking Design Center” offered on the website www.us.hilti.com as well as the respective approvals.

Recommended shear bearing loads V_{rec}

Sheeting thickness t_f		X-HSN24, X-EDNK22 and X-EDN19	
[Gauge]	[mm]	V_{rec} [lbs]	[kN]
22	0.76	500	2.20
20	0.91	600	2.64
18	1.21	785	3.45
16	1.52	975	4.29

- Valid for steel sheet with a minimum tensile strength of 45 ksi (310 N/mm²). Values refer to failure controlled by the single sheet metal attached.
- For intermediate sheet thicknesses, linear interpolation is allowed.
- Recommended loads include safety factor 3.0 applied to mean shear resistance Q_f . An equation for Q_f is published in the SDI (Steel Deck Institute) Diaphragm Design Manual, 3rd edition.

Recommended tension load N_{rec}

Sheeting thickness t_f		X-HSN24, X-EDNK22		X-EDN19	
[Gauge]	[mm]	N_{rec} [lbs]	[kN]	N_{rec} [lbs]	[kN]
22	0.76	355	1.56	340	1.52
20	0.91	435	1.95	340	1.52
18	1.21	435	1.95	340	1.52
16	1.52	435	1.95	340	1.52

- Valid for steel sheet with minimum tensile strength of 45 ksi (310 N/mm²). Values are either controlled by pullover of sheet or by minimum value of fastener pullout of base metal.
- Values require fastener point penetration for X-EDNK22 and X-EDN19, of $\neq 0$ (12.7 mm). Higher recommended values be applicable for X-HSN24 (see Hilti North America “Steel Deck Fastening Systems”)
- Recommended loads include a safety factor 3.0 applied to mean pullover resistance or a safety factor 5.0 applied to the mean value of pullout resistance.

Design data for use in Europe

Currently, the X-HSN24, X-EDNK22 and the X-EDN19 fasteners are only used in North America. Therefore, no design data is published evaluated in strict compliance with the provisions for European Technical Approvals.

For European markets, the fastener X-ENP2K-20 L15 in connection with the fastening tools DX 76 or DX 76 PTR are recommended for sheet metal fastenings to thin base materials (3 to 6 mm).

Application limits and requirements

Fastening tool DX 860-HSN, DX 9-HSN

Fastener	Base material properties		Ultimate tensile strength	
	Thickness [inch]	[mm]	[ksi]	[N/mm ²]
X-EDNK22	1/8" to 1/4"	3.2 to 6.35	58 to 91	400-630
X-EDN 19	3/16" to 5/16"	4.8 to 8.0	58 to 91	400-630
	5/16" to 3/8"	8.0 to 9.5	58 to 68	400-470

- Comment on fastening tool DX 460-SM and DX 5-SM: This fastening tool is recommended for base material thickness from 3/16" to 3/8" (4.8 to 8.0 mm). The same strength limits apply as with the DX 860-HSN and DX 9-HSN.
- X-HSN24 covers full range of the fasteners X-EDNK22 and X-EDN19.

Thickness of fastened material, fastener patterns, spacings and edge distance

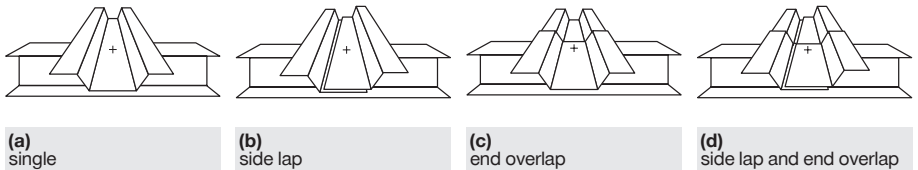

As part of a steel deck diaphragm, all four fastening types (a), (b), (c) and (d) are executed with the X-HSN 24, X-EDNK22 and the X-EDN19. The sheet metal thickness typically varies between 22 Gauge (0.76 mm) and 16 Gauge (1.52 mm).

Dependent on the base material thickness and the frame fastener pattern, restrictions on the use of thicker decking might apply. For corresponding details of these provisions, it is referred to the quoted technical literature published by Hilti North America. This literature also contains details with respect to fastener patterns, spacings and edge distance adequately addressing the specifics of the diaphragm components used in the North American market.

Corrosion information

The intended use only comprises fastenings which are not directly exposed to external weather conditions or moist atmospheres. For further detailed information on corrosion see relevant chapter in **Direct Fastening Principles and Technique** section.

Fastener selection and system recommendation

Fasteners	Designation	Item no.	Tool
Collated nails	X-HSN24	2042971	DX 860-HSN DX 9-HSN
	X-EDNK22 THQ12 M, grey magazine strip	34133	
	X-EDN19 THQ12 M, white magazine strip	34134	

Cartridge selection and tool energy setting

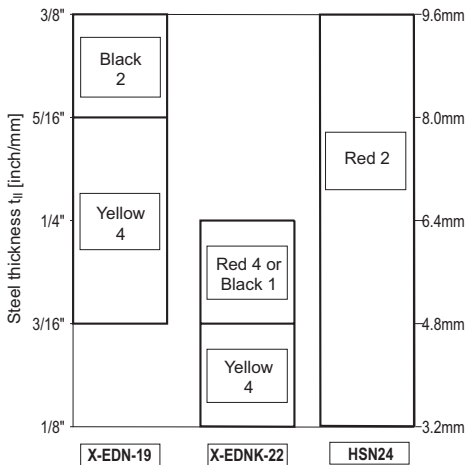

Fine adjustment by installation tests on site.

Fastening quality assurance

Fastening inspection

X-HSN 24

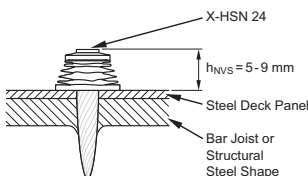

X-EDNK22 THQ12 / X-EDN19 THQ12

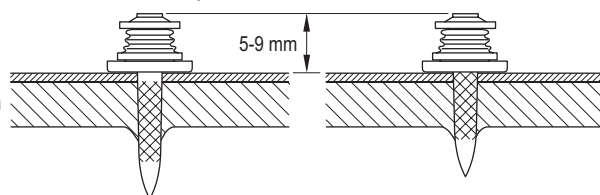

NPH Siding and decking nail

Product data

Dimensions

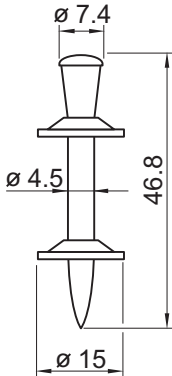

General information

Material specifications

Carbon steel shank:	HRC 58
Zinc coating:	8–16 µm

Recommended fastening tools:

DX 76 PTR with DX 76-F-Kwik-PTR fastener guide DX 76 with X-76-F-Kwik fastener guide	Cartridges: 6.8/18M blue, yellow
--	-------------------------------------

See **Tools and equipment** for more details.

Approvals

SOCOTEC (France)
BUtgb (Belgium)

Note:

Technical data presented in these approvals and design guidelines reflect specific local conditions and may differ from those published in this handbook.

Applications

Examples

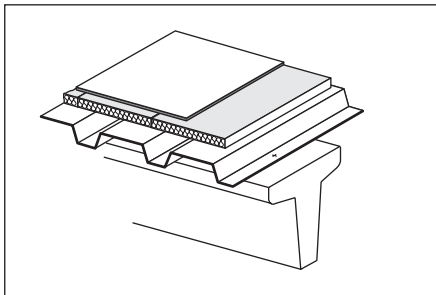

Roof decking

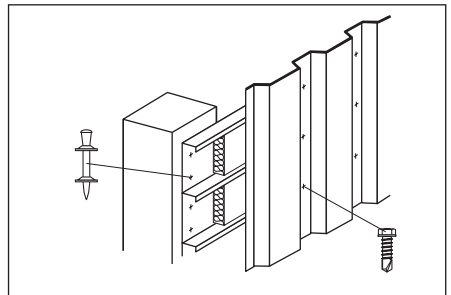

Wall liners

Load data

Recommended loads

Sheeting thickness t_f [mm] nominal	Trapezoidal profile (symmetric)		Liner trays (asymmetric)	
	N_{rec} [kN]	V_{rec} [kN]	N_{rec} [kN]	V_{rec} [kN]
0.75	1.80	1.20	1.30	1.20
0.88	2.10	1.50	1.50	1.50
1.00	2.40	1.80	1.70	1.80
1.13	2.70	2.20	1.90	2.20
1.25	3.00	2.50	2.10	2.50
1.50	3.00	3.00	2.50	3.00
1.75	3.00	3.00	2.50	3.00
2.00	3.00	3.00	2.50	3.00

- Recommended working loads valid for steel sheets with a minimum tensile strength of ≥ 360 N/mm².
- For intermediate sheet thicknesses, use recommended load for next smaller thickness.
- Recommended loads are appropriate for EC1 (or similar) wind loading designs.
- The safety factor included is at least 2.0 applied to the static 5 % fracture value and 1.3 to the cyclic (5000 cycles) 5 % fracture value.

Application requirements

Thickness of base material

Minimum thickness of concrete member

$h_{min} = 160$ mm

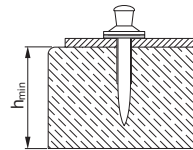

Thickness of fastened material

Sheet thicknesses and overlap types

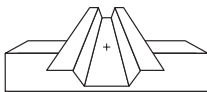

(a)
single

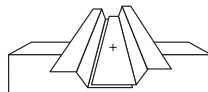

(b)
side lap

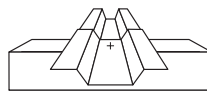

(c)
end overlap

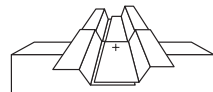

(d)
side lap and end overlap

Nominal sheeting thickness t_f [mm]	Allowable overlap types
0.63–1.13	a, b, c, d
> 1.13–2.50	a

- With the above recommended sheet thickness and overlap types, the effects of temperature induced forces of constraint during construction can be neglected.
- These recommendations are valid for sheets up to S350GD.
- With other sheets or overlaps or when unusually large forces of constraint are expected, analyse the structural system to ensure that the shear force acting on the nail does not exceed V_{rec} .

Spacing and edge distances (mm)

Trapezoidal profiles to girders or purlins

Liner trays to columns

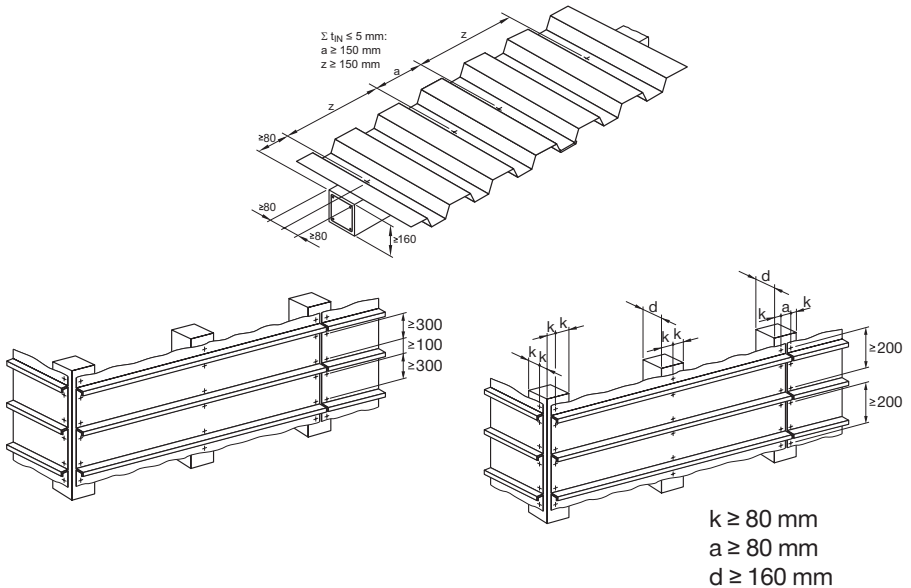

Corrosion information

The intended use only comprises fastenings which are not directly exposed to external weather conditions or moist atmospheres. For further detailed information on corrosion see relevant chapter in **Direct Fastening Principles and Technique** section.

Application limits

Types of concrete

- Precast and cast-in-place pre-stressed concrete
- Precast and cast-in-place reinforced concrete

Concrete design strength

- Minimum C20/25 ($f_c = 20 \text{ N/mm}^2$, $f_{cc} = 25 \text{ N/mm}^2$)
- Maximum C45/55 ($f_c = 45 \text{ N/mm}^2$, $f_{cc} = 55 \text{ N/mm}^2$)
- The **NPH/DX-Kwik** system has been successfully used in concrete having an in-place cube strength of 70 N/mm^2

Minimum strength/age at time of fastening

- C20/25 concrete must be 28 days old
- C45/55 concrete must be 15 days old

Minimum dimensions of concrete member

- Minimum width = 180 mm
- Minimum thickness = 160 mm

Fastener selection

Fasteners		Tool	Fastener guide	Piston
Designation	Item no.	Designation	Designation	Designation
NPH2-42 L15	40711	DX 76	X-76-F-Kwik	X-76-P-Kwik
		DX 76 PTR	X-76-F-Kwik-PTR	X-76-P-Kwik-PTR

Cartridge selection and tool energy setting

Cartridges 6.8/18 M blue

Tool energy adjustment by setting tests on site

Fastening quality assurance

Installation

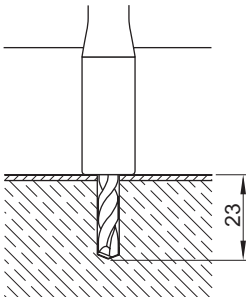

Pre-drill with TX-C-5/23 drill bit
(Item no.: 00061787)

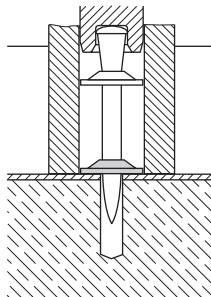

Place fastener with DX 76 PTR
or DX 76

Fastening inspection

NPH2-42 L15

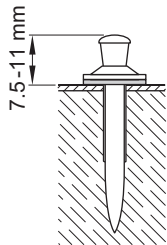

Check for conformity with recommendations
(detailing spacing and edge distances for fastening)

Check the nailhead standoff of completed fastenings

These are abbreviated instructions which may vary by application.

ALWAYS review/follow the instructions accompanying the product.

X-HVB Shear connector

Product data

Dimensions

X-HVB 140

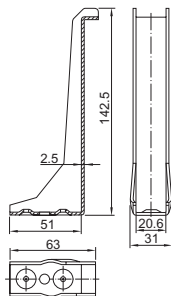

X-HVB 125

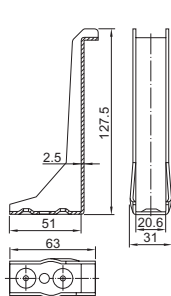

X-HVB 110

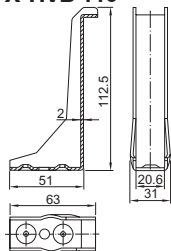

X-HVB 95

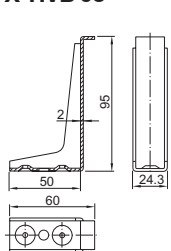

X-HVB 80

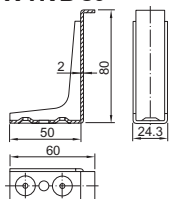

X-HVB 50

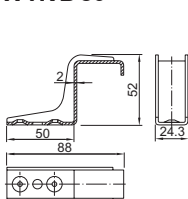

X-HVB 40

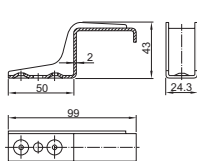

X-ENP-21 HVB

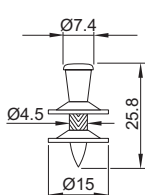

General information

Material specifications

X-HVB

Carbon steel: $R_m = 295\text{--}350 \text{ N/mm}^2$

Zinc coating: $\geq 3 \mu\text{m}$

X-ENP-21 HVB

Carbon steel shank: HRC58

Zinc coating: $8\text{--}16 \mu\text{m}$

Recommended fastening tools

Tool DX 76 DX 76 PTR

Fastener guide X-76-F-HVB X-76-F-HVB-PTR

Piston X-76-P-HVB X-76-P-HVB-PTR

Cartridges 6.8/18M black, red
(for details see application
limit X-ENP-21 HVB)

See **Tools and equipment** for more details.

Approvals and design guidelines

ETA-15/0876, design according to
Eurocode 4 (EN 1994-1-1, EN 1994-1-2)
and Eurocode 8 (EN 1998-1)

MLIT / BCJ (Japan)

With regard to composite design according to AISC
(American Institute of Steel Construction), please
refer to the technical literature of Hilti North America
(Product Technical Guide)

Applications

Examples

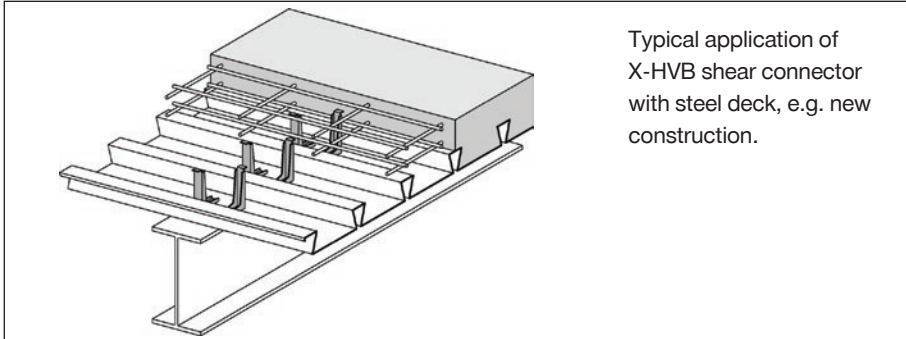

Typical application of X-HVB shear connector with steel deck, e.g. new construction.

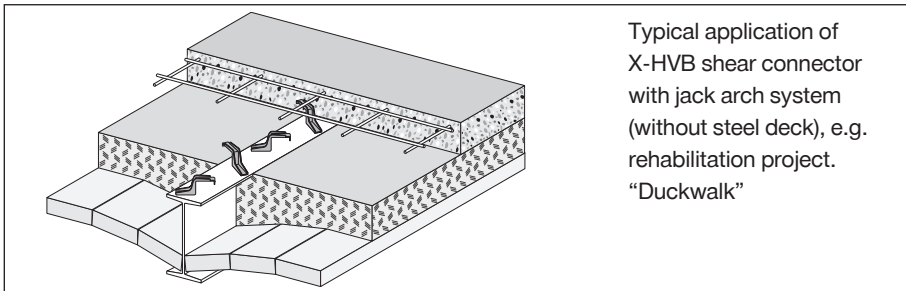

Typical application of X-HVB shear connector with jack arch system (without steel deck), e.g. rehabilitation project. "Duckwalk"

Characteristic and design resistance (ETA-15/0876) in composite beams with solid slabs

Shear Connector	Characteristic Resistance P_{Rk} [kN]	Design Resistance P_{Rd} [kN]	Minimum base material thickness [mm]	X-HVB positioning	Ductility assessment
X-HVB 40	29	23	6	"duckwalk"	Ductile according to EN 1994-1-1
X-HVB 50	29	23	6		
X-HVB 80	32.5	26	8 ^{*)}	parallel with beam	
X-HVB 95	35	28			
X-HVB 110	35	28			
X-HVB 125	37.5	30			
X-HVB 140	37.5	30			

^{*)} Reduction to 6 mm possible, with regards to required reduction of design resistance see annex C3 of ETA-15/0876.

Conditions:

- Normal weight concrete C20/25 to C50/60
- Light weight concrete LC20/22 to LC50/55 with a minimum density $\rho = 1750 \text{ kg/m}^3$

Design resistance in composite beams with decking ribs transverse to beam axis

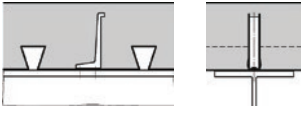
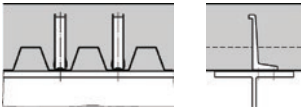
X-HVB positioning	Design Resistance $P_{Rd,t}$ [kN]	Ductility assessment
 <p>X-HVB positioning longitudinal with the beam</p>	$P_{Rd,t,t} = k_{t,l} \cdot P_{Rd}$ $k_{t,l} = \frac{0.66}{\sqrt{n_r}} \cdot \frac{b_0}{h_p} \cdot \left(\frac{h_{SC}}{h_p} - 1 \right) \leq 1.0$	Ductile according to EN 1994-1-1
 <p>X-HVB positioning transverse with the beam</p>	$P_{Rd,t,t} = 0.89 \cdot k_{t,t} \cdot P_{Rd}$ $k_{t,t} = \frac{1.18}{\sqrt{n_r}} \cdot \frac{b_0}{h_p} \cdot \left(\frac{h_{SC}}{h_p} - 1 \right) \leq 1.0$	

Conditions:

- Applicable for X-HVB 80, X-HVB 95, X-HVB 110, X-HVB 125, X-HVB 140
- n_r corresponds to the number of X-HVBs per rib ($n_r \leq 3$)

Design resistance in composite beams with decking ribs parallel to beam axis

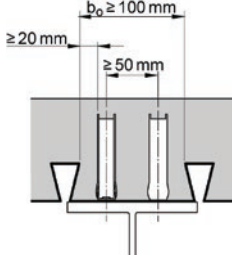
X-HVB positioning	Design Resistance $P_{Rd,t}$ [kN]	Ductility assessment
 <p>X-HVB positioning longitudinal with the beam</p>	$P_{Rd,t} = k_l \cdot P_{Rd}$ $k_l = 0.6 \cdot \frac{b_0}{h_p} \cdot \left(\frac{h_{SC}}{h_p} - 1 \right) \leq 1.0$	Ductile according to EN 1994-1-1

Conditions:

- Applicable for X-HVB 80, X-HVB 95, X-HVB 110, X-HVB 125, X-HVB 140
- X-HVB are to be positioned parallel with beam

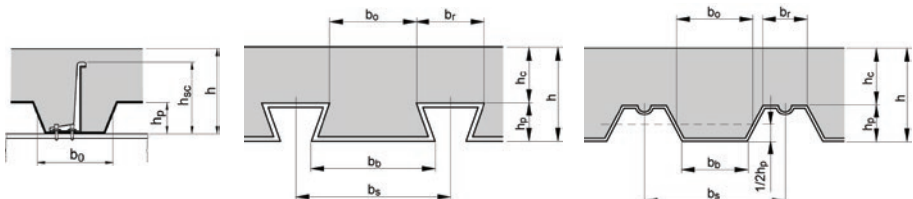
Decking geometric parameters

Design information

Connector placement along the beam

The X-HVB is a ductile shear connector according to EN 1994-1-1, section 6.6, and may be uniformly distributed between critical sections. These critical sections, where large changes in shear flow occur, may be at supporting points, points of application of point loads or areas with extreme bending moments.

Partial shear connection

Strength:

The minimum connection depends on the design code used:

In **EN 1994-1-1** design, N/N_f must be at least 0.4. This increases depending on span length and decking geometry.

Deflection control only

If the shear connection is needed for deflection control only, there is no minimum degree of connection. However, minimum allowable connector spacing applies and the steel beam must have enough strength to carry the self-weight and all imposed loads.

Further specific design topics covered in the ETA-15/0876

- Coverage of seismic loading according to Eurocode 8 (EN 1998-1-1)
- Design resistance in case of use of old steel with an ultimate strength greater than 300 N/mm² and less than 360 N/mm²
- Effect of reduced base material thickness less than 8 mm for X-HVB 80 to X-HVB 140
- Design of end anchorage of composite slabs
- Design in case of a fire

Application requirements

Thickness of base material

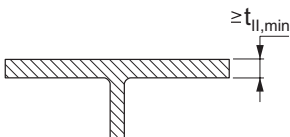

For beams with composite decking:
minimum thickness $t_{II} = 8$ mm.

For beams with solid concrete slabs:
minimum thickness $t_{II} = 6$ mm, especially relevant in renovation projects in order to take the thin flange thickness of small I-sections (e.g. IAO 100, I 100, IPE 100) into account.

Thickness of fastened material

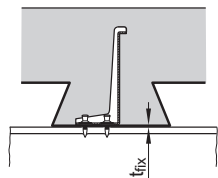

Maximum total thickness of fixed sheeting t_{fix} :

- 2.0 mm for X-HVB 80, X-HVB 95 and X-HVB 110
- 1.5 mm for X-HVB 125 and X-HVB 140

Positioning of X-HVB connectors in solid concrete slabs

X-HVB are to be positioned parallel with beam

1 row of connectors

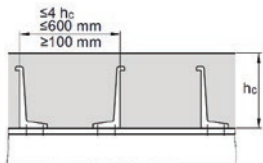

2 row of connectors

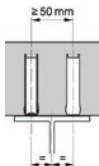
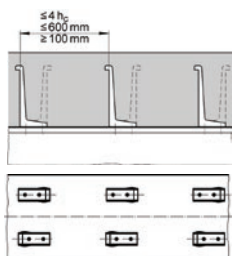

Maximum 3 row of connectors

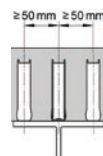
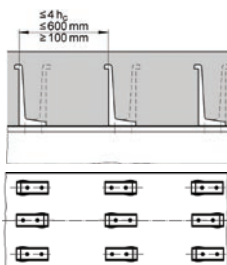

Positioning of X-HVB connectors with composite deck (deck positioned transverse to and X-HVB positioned parallel with beam axis)

Spacing and positioning

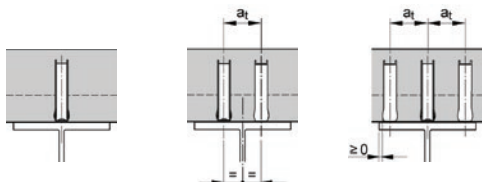

- $a_t \geq 50$ mm for compact profiled decking with $b_0/h_p \geq 1.8$
- $a_t \geq 100$ mm for other decking

1 row of connector - Minimum rib width and spacing to decking

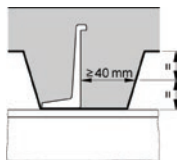
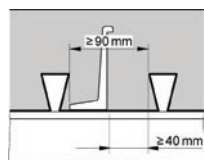

Rib width < 105mm

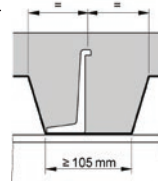

Rib width ≥ 105mm

Multiple rows of connector - Minimum rib width

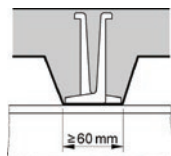

Positioning of X-HVB connectors with composite deck (deck and X-HVB positioned transverse to beam axis)

Spacing

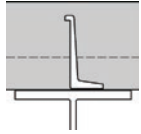

1 row

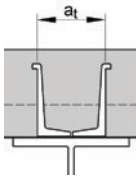

2 rows

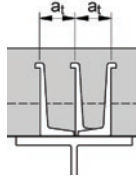

3 rows

2 rows:

- $a_t \geq 100$ mm for all types decking

3 rows:

- $a_t \geq 50$ mm for compact profiled decking with $b_0/h_p \geq 1.8$
- $a_t \geq 100$ mm for other decking

Positioning - 1 row of connectors

Without rib stiffener

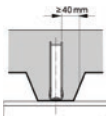

Center in rib

With rib stiffener (X-HVB in contact with rib stiffener)

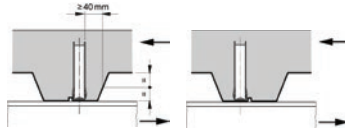

Preferred position in compression zone of concrete rib

Positioning - 2 and 3 rows of connectors

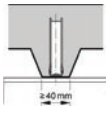

Minimum width of deck rib

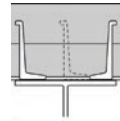
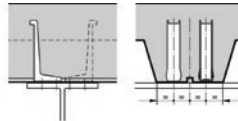
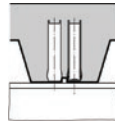
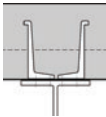

Contact with rib stiffener
OR
equi-spacing

Positioning of X-HVB connectors with composite deck (deck parallel with beam axis)

X-HVB are to be positioned parallel with beam

Spacing and positioning

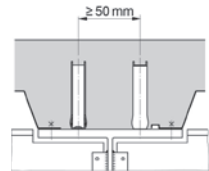
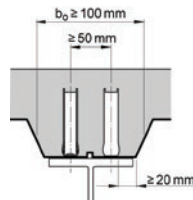
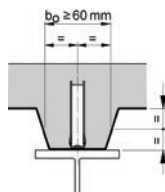
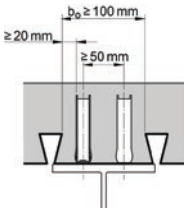

- If a centric positioning within the concrete rib is not possible due to the shape of the composite decking, the decking needs to be split.

“Duckwalk” positioning of X-HVB 40 and 50 in combination with thin solid slabs for renovation construction

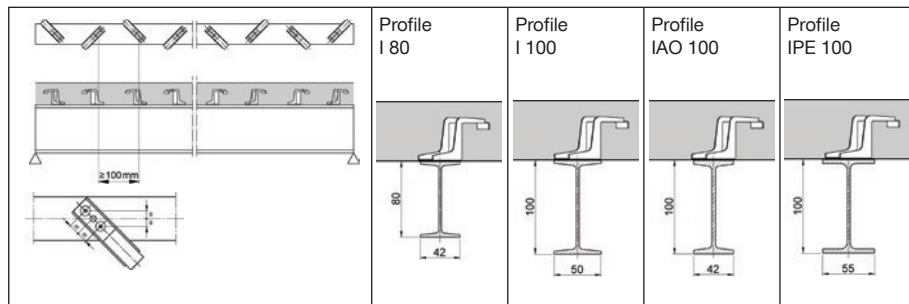

- Minimum section width = 40 mm (e.g. old section IAO 100)
- Minimum center distance of steel sections = 400 mm

Application limits

Application limits are valid only if correct cartridge and power setting are used!

Application limits X-ENP-21 HVB

Cartridge preselection and power setting

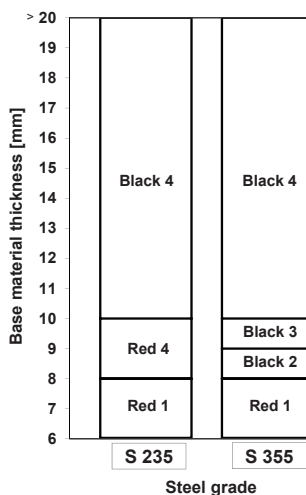
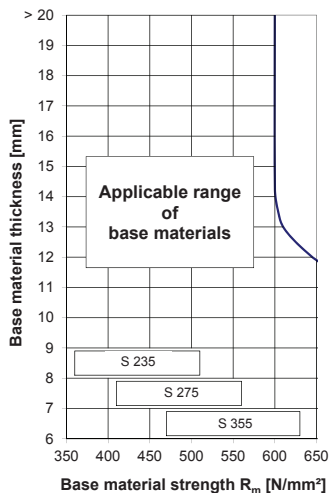

In thermo-mechanically rolled construction steel, e.g. S 355M per EN 10025-4 the application limit is reduced by 50 N/mm²

Fine adjustment by carrying out installation tests on site

- Minimum section covered: IPE 100
- Minimum base material thickness for beams with composite decking: 8 mm

Fastener selection

Minimum slab thickness

X-HVB	Minimum slab thickness h [mm]	
	Without effect of corrosion	With effect of corrosion
40	50	60
50	60	70
80	80	100
95	95	115
110	110	130
125	125	145
140	140	160

Maximum decking height h_p , dependent on decking geometry

X-HVB	Maximum height of composite decking h_p [mm]		
	$\frac{b_o}{h_p} \geq 1.8$	$1.0 < \frac{b_o}{h_p} < 1.8$	$\frac{b_o}{h_p} \leq 1.0$ x)
80	45	45	30
95	60	57	45
110	75	66	60
125	80	75	73
140	80	80	80

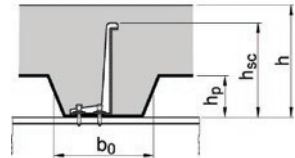

x) $b_o/h_p \geq 1.0$ for composite decking perpendicular to beam combined with X-HVB orientation parallel with beam

Fastening quality assurance

Fastening inspection

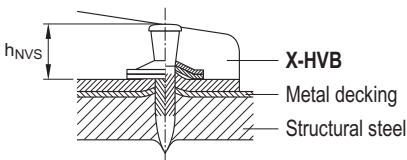

$$8.2 \text{ mm} \leq h_{NVS} \leq 9.8 \text{ mm}$$



Clearly visible piston mark on top washer

X-U Nail for fastening to concrete and steel

Product data

Dimensions

X-U __ MX

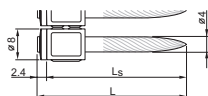

X-U __ P8

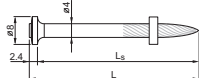

X-U __ P8 S36

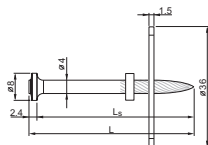

X-U __ P8 S15

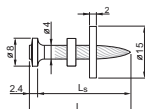

X-U 15 P8TH

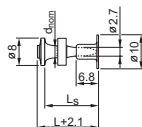

X-U __ S12

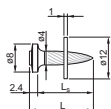

General information

Material specifications

Carbon steel shank: HRC 58
HRC 59 (X-U 15)
Zinc coating: 5–20 µm

Recommended fastening tools

See **X-U fastener program** in the next pages and **Tools and equipment** chapter for more details.

Approvals

ICC ESR-2269 (USA)
DIBt Z-14.4-517 (Germany), DNV-GL
ABS, LR 97/00077, IBMB 2006/2011

Note: technical data presented in these approvals and design guidelines reflect specific local conditions and may differ from those published in this handbook.

Applications

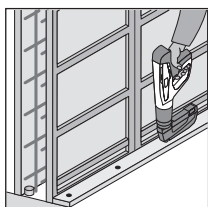

System formwork

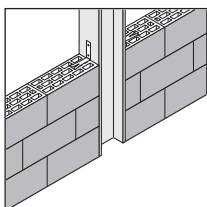

Wall-tie to steel and concrete

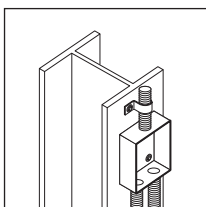

Mechanical and electrical fixtures

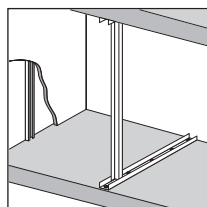

Drywall track to concrete and steel

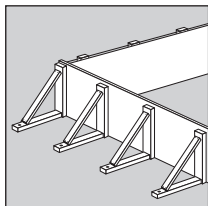

Conventional formwork

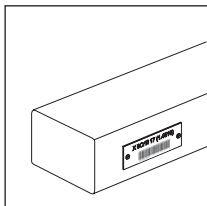

Tagging labels

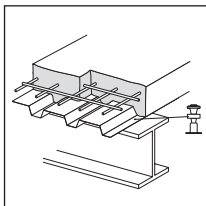

Tacking of metal decks

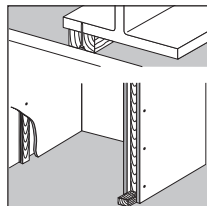

Sill plates / 2x4 wood to concrete and steel

The intended use for safety relevant and permanent applications only comprises fastenings which are not directly exposed to external weather conditions or moist atmospheres.

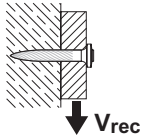
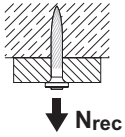
Fastening to Concrete
Recommended loads

N_{rec} [kN]	V_{rec} [kN]	h_{ET} [mm]
0.4	0.4	≥ 27
0.3	0.3	≥ 22
0.2	0.2	≥ 18
0.1	0.1	≥ 14

Design conditions:

- For safety relevant fastenings sufficient redundancy of the entire system is required:
Minimum 5 fastenings per fastened unit.
- All visible failures must be replaced.
- Valid for concrete with strength of $f_{cc} \leq 45 \text{ N/mm}^2$.
- Valid for predominantly static loading.
- Failure of the fastened material is not considered in recommended loads
- To limit penetration of nail and to increase pull-over load, use nails with washers.

Fastening to Concrete

Application requirements

Thickness of base material

Concrete:

$h_{min} = 80 \text{ mm}$

Thickness of fastened material

Wood:

$t_1 = 15\text{--}57 \text{ mm}$

Edge distance and fastener spacing

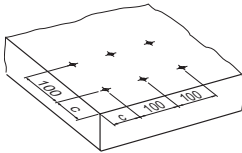

Edge distance:

$c \geq 70 \text{ mm}$

Spacing:

$s \geq 100 \text{ mm}$

Fastener selection and system recommendation

Fastening to concrete

Required nail shank length: $L_S = h_{ET} + t_1$ [mm]

Recommendation: $h_{ET} = 22 \text{ mm}$

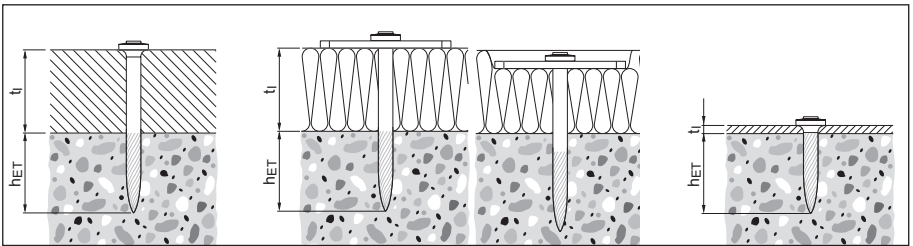

In case flush fastenings are required:

$L_S = h_{ET} + t_1 - 5$ [mm]

Cartridge recommendation

Tool energy adjustment by setting tests on site

Fastening to concrete: **6.8/11M yellow cartridge** on soft and tough concrete

6.8/11M red cartridge on very tough concrete

Fastening to Steel

Recommended loads

Fastening of steel sheets and other steel parts with X-U 16 and X-U 19

Recommended loads t_f [mm]	X-U_P8/MX N_{rec} [kN]	X-U_S12 N_{rec} [kN]	V_{rec} [kN]
0.75	1.0	1.4	1.2
1.00	1.2	1.8	1.8
1.25	1.5	2.2	2.6
≥ 2.00	2.0	2.2	2.6

Tacking of steel sheets with X-U 15

according to ECCS-recommendation N73, „Good Construction Practice for Composite Slabs ”

Recommended loads t_f [mm]	N_{rec} [kN]	V_{rec} [kN]
0.75–1.25	0.6	0.8

Design conditions:

- Recommended working loads valid for steel sheet with minimum tensile strength $\geq 360 \text{ N/mm}^2$.
- For intermediate sheet thicknesses, use recommended load for next smaller thickness.
- In case of a design based on the characteristic resistance, recommended values have to be multiplied by two: $\Rightarrow N_{Rk} = N_{rec} \cdot 2.0$ $V_{Rk} = V_{rec} \cdot 2.0$
- For X-U 16 S12: base material thickness $t_{II,min} = 8 \text{ mm}$ for $t_f \geq 1.5 \text{ mm}$ and $t_{II,min} = 6 \text{ mm}$ for $t_f \leq 1.25 \text{ mm}$
- Other fastened parts: clips, brackets, etc.
- Redundancy (multiple fastening) must be provided.
- Valid for predominantly static loading

Forces of constraint

When fastening large pieces of steel, the possibility of shear loadings from forces of constraint should be considered. Avoid exceeding V_{rec} for the fastener shank!

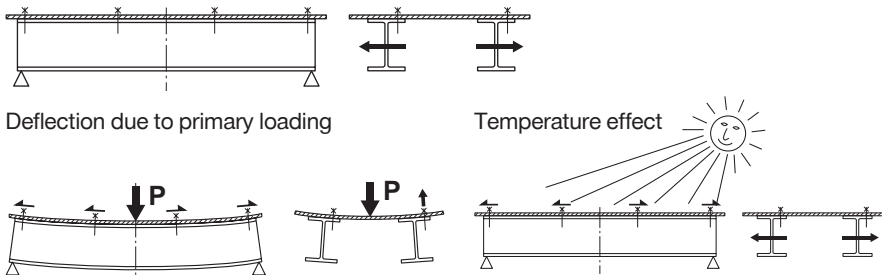

Fastening to Steel

Fastenings of wood to steel

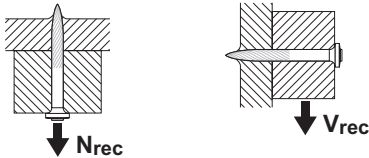

$$N_{rec} = 0.3 \text{ kN}$$

$$V_{rec} = 0.6 \text{ kN}$$

Design conditions:

- For safety-relevant fastenings sufficient redundancy of the entire system is required.
- In case soft material is fastened, its strength determines the loads.
- To limit penetration of nail and to increase pull-over load, use nails with washers.
- Observance of edge distance and fastener spacing in compliance with recognized standards EN 1995 (see approval).
- With respect to details of fastening wood, chipboard or OSB members to steel base material, it is referred to the German approval DIBt Z-14.4-517.

Application requirements

Thickness of base material

Steel:

$$t_{II} \geq 6.0 \text{ mm (fastening steel to steel)}$$

$$t_{II} \geq 4.0 \text{ mm (fastening wood to steel)}$$

Thickness of fastened material

Steel:

$$t_I \leq 3 \text{ mm (fastened material not pre-drilled)}$$

$$3 \text{ mm} < t_I \leq 6 \text{ mm (fastened material pre-drilled)}$$

Wood:

$$t_I = 15\text{--}57 \text{ mm}$$

Condition for thick fastened steel parts ($3 \text{ mm} < t_I \leq 6 \text{ mm}$)

If a gap between the fastened part and the base material is unacceptable, the fastened part needs to be prepared with drilled holes.

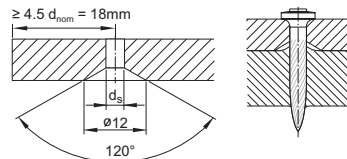

Edge distance and spacing

Rolled shapes:

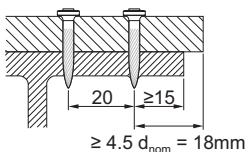

Edge distance: $c \geq 15 \text{ mm}$

Spacing: $a = 20 \text{ mm}$

Fastening to Steel

Application limits

Fastening of steel sheets and steel parts to steel

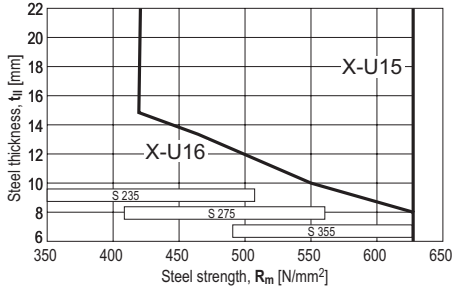

Fastening of wood and soft material to steel

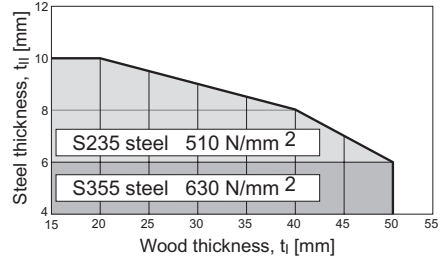

X-U 16 P8, X-U 15 P8TH: For steel sheeting with $0.75 \text{ mm} \leq t_1 \leq 1.25 \text{ mm}$ sheets

For X-U 22 P8 to X-U 62 P8

On higher steel grades, fastening with single nails (P8 or P8TH) may yield better results (e.g. less shear brakes) than fastening with collated nails (MX or MXSP) due to better nail guidance.

Fastener selection and system recommendation

Required nail shank length: $L_S = h_{ET} + t_1$ [mm]

Fastening steel to steel

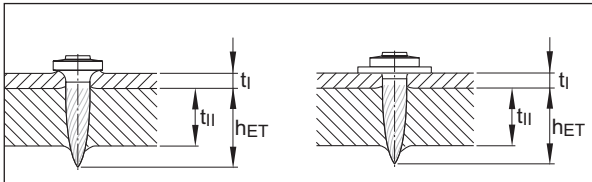

Recommendation: $h_{ET} = 12 \pm 2 \text{ mm}$

Fastening wood to steel

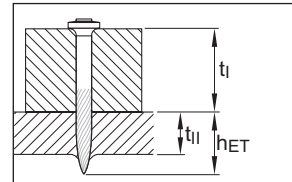

$h_{ET} \geq 8 \text{ mm}$
 $h_{ET} \geq 5 \text{ mm}$ for flush installation

Cartridge recommendation

Tool energy adjustment by setting tests on site

Fastening wood to steel: 6.8/11M green or yellow cartridge

on steel thickness $t_{II} < 6 \text{ mm}$

6.8/11M yellow, red or black cartridge

on steel thickness $t_{II} \geq 6 \text{ mm}$

Fastening steel to steel: 6.8/11M yellow, red or black cartridge

Fastening to Steel

X-U 16

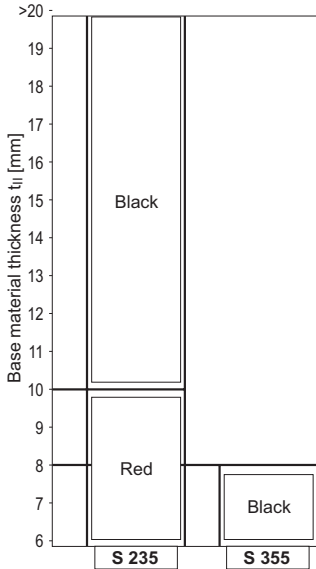

X-U 15 P8TH

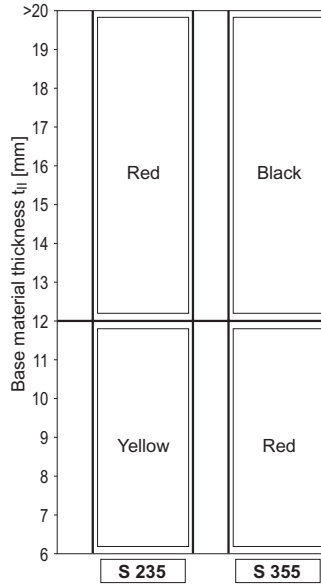

Fastening quality assurance

Fastening inspection

X-U __ P8/MX

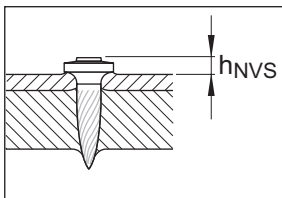

$h_{NVS} = 2.5-4.5 \text{ mm}$

X-U __ S12

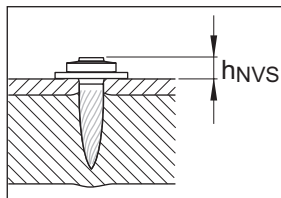

$h_{NVS} = 4.0-5.5 \text{ mm}$

X-U _ P8TH / MXSP

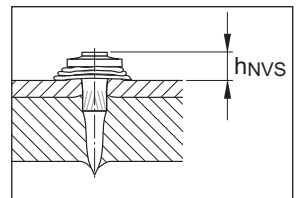

$h_{NVS} = 4.0-6.0 \text{ mm}$

Fastener program

Fastener	Item no.	L _s [mm]	Standard tools						Special tools		Key applications
			DX 460 MX, DX 5 MX	DX 460 FB, DX 5 FB	DX 36, DX 2	DX E72	DX 351 MX	DX 351 FB	DX 35	DX 462 FB	
X-U 16 MX	237344	16	■				■				Sheet metal on steel
X-U 19 MX	237345	19	■				■				Sheet metal on steel
X-U 22 MX	237346	22	■				■				Wood on concrete/steel
X-U 27 MX	237347	27	■				■				Wood on concrete/steel
X-U 32 MX	237348	32	■								Wood on concrete/steel
X-U 37 MX	237349	37	■								Wood on concrete/steel
X-U 42 MX	237350	42	■								Wood on concrete/steel
X-U 47 MX	237351	47	■								Wood on concrete/steel
X-U 52 MX	237352	52	■								Wood on concrete/steel
X-U 57 MX	237353	57	■								Wood on concrete/steel
X-U 62 MX	237354	62	■								Wood on concrete/steel
X-U 72 MX	237356	72	■								Wood on concrete/steel
X-U 16 P8	237330	16		■	■	■		■	■	■	Sheet metal on steel
X-U 19 P8	237331	19		■	■	■		■	■	■	Sheet metal on steel
X-U 22 P8	237332	22		■	■	■		■	■	■	Wood on concrete/steel
X-U 27 P8	237333	27		■	■	■		■	■	■	Wood on concrete/steel
X-U 32 P8	237334	32		■	■	■		■	■	■	Wood on concrete/steel
X-U 37 P8	237335	37		■	■	■		■	■	■	Wood on concrete/steel
X-U 42 P8	237336	42		■	■	■		■	■	■	Wood on concrete/steel
X-U 47 P8	237337	47		■	■	■		■	■	■	Wood on concrete/steel
X-U 52 P8	237338	52		■	■	■		■	■	■	Wood on concrete/steel
X-U 57 P8	237339	57		■	■	■		■	■	■	Wood on concrete/steel
X-U 62 P8	237340	62		■	■	■		■	■	■	Wood on concrete/steel
X-U 72 P8	237342	72		■	■	■		■	■	■	Wood on concrete/steel
X-U 16 P8TH	237329	16		■	■	■		■	■	■	Sheet metal on steel, *)
X-U 19 P8TH	385781	19		■	■	■		■	■	■	Sheet metal on steel, *)
X-U 27 P8TH	385782	27		■	■	■		■	■	■	Sheet metal on concrete, *)
X-U 15 MXSP	383466	16	■				■				Sheet metal on steel
X-U 15 P8TH	237328	16		■	■	■		■	■	■	Sheet metal on steel

*) firm hold down

Fastener	Item no.	Ls [mm]	Standard tools						Special tools		Key applications
			DX 460 MX, DX 5 MX	DX 460 F8, DX 5 F8	DX 36, DX 2	DX E72	DX 351 MX	DX 351 F8	DX 35	DX 462 F8	
X-U 27 P8S15	237371	27	■	■	■			■	■	■	High pull-over strength
X-U 32 P8S15	237372	32	■	■	■			■	■	■	High pull-over strength
X-U 32 P8S36	237374	32	■	■	■			■	■	■	Soft material on concr./steel
X-U 52 P8S36	237376	52	■	■	■			■		■	Soft material on concr./steel
X-U 72 P8S36	237379	72	■	■	■						Soft material on concr./steel
X-U 16 S12	237357	16								■	High pull-over strength
X-U 19 S12	237358	19								■	High pull-over strength
X-U 22 S12	237359	22								■	High pull-over strength
X-U 27 S12	237360	27								■	High pull-over strength
X-U 32 S12	237361	32								■	High pull-over strength

■ = Recommended

■ = Feasible

X-P Nail for fastening to concrete and steel

Product data

X-P_MX

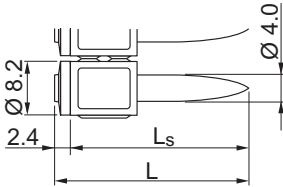

X-P_P8

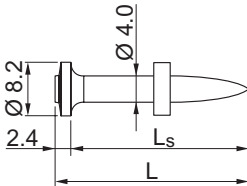

Features and Benefits

A **specially hardened fastener** with a **long conical tip** optimized for high load and stick rate for applications on **soft & tough** concrete and wood to steel.

General information

Recommended fastening tools

See **X-P fastener program** in the next pages and **Tools and equipment** chapter for more details

Approvals and Certificates

IBMB (Germany), VHT (Germany), ICC-ESR 2269 (USA), COLA RR25675 (USA)

Material Specifications

Carbon Steel 59HRC 4mm shank diameter Long Conical Tip
Zinc Coating 5–20µm

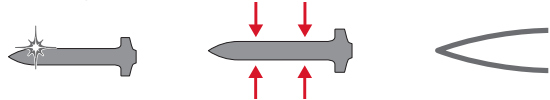

Applications

Example

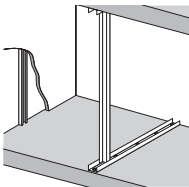

Drywall tracks

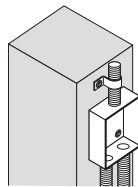

Mechanical, electrical

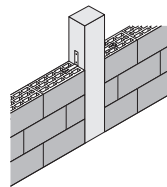

Wall ties

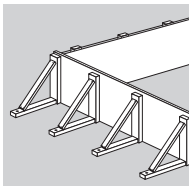

Formwork

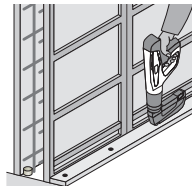

System formwork

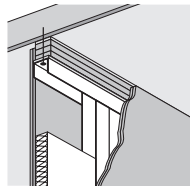

Deflection Head

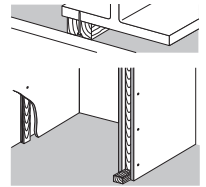

Wood Frame

The intended use for safety relevant and permanent applications only comprises fastenings which are not directly exposed to external weather conditions or moist atmospheres.

Fastening sheet metal attachments to concrete

Performance data

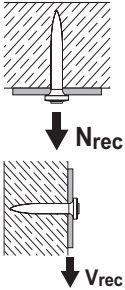

Embedment h_{ET} [mm]	Recommended Loads [kN]				Typical cartridge colour selection Type 6.8/11	
	Tension N_{rec}		Shear V_{rec}			
	Concrete Toughness					
	Soft	Tough	Soft	Tough	Soft	Tough
≥ 25	0.40	0.20	0.80	0.40	Red	Red/ Black
≥ 20	0.30	0.15	0.60	0.30		
≥ 18	0.20	0.10	0.40	0.20	Green/ Yellow	Red

Conditions:

- For safety relevant fastenings sufficient redundancy of the entire system is required: Minimum of 5 nails per fastened track. All visible setting failures must be replaced.
- Sheet metal failure is not considered in recommended loads and must be assessed separately
- Soft concrete up to $f_{c,cube} = 45 \text{ N/mm}^2$, Tough concrete up to $f_{c,cube} = 65 \text{ N/mm}^2$.
- Concrete with aggregate like granite or river rock or softer, and up to 16 mm diameter

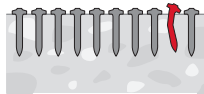

Stick rate estimation	
Soft Concrete	Tough Concrete
95% - 99%	90% - 95%

- The stick rate indicates the percentage of nails that were driven correctly to carry a load. Stick rate can vary from the above values depending on job site conditions.

Application requirements

Thickness of base material

Concrete:

$h_{min} = 80 \text{ mm}$

Permissible sheet metal thickness

Sheet metal:

$t_1 = 0.60 - 2.00 \text{ mm}$

Edge distance and fastener spacing

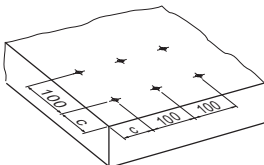

Edge distance:

$c \geq 70 \text{ mm}$

Spacing:

$s \geq 100 \text{ mm}$

For standard light partition wall track: $s \leq 60 \text{ cm}$

For track in proprietary fire rated light partition walls: $s \leq 30 \text{ cm}$

Fastener shank length (L_S) selection

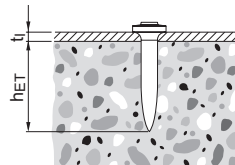

Required nail shank length:

Recommendation:

$L_S = h_{ET} + t_1$ [mm]

$h_{ET} = 20 \text{ mm}$

Fastening Wood to concrete (Wood Framing, Formwork)

Performance data

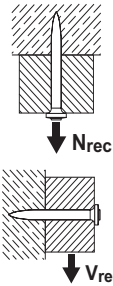

Embedment h_{ET} [mm]	Recommended Loads [kN] Tension N_{rec} = Shear V_{rec}		Typical cartridge colour selection Type 6.8/11	
	Concrete Toughness			
	Soft	Tough	Soft	Tough
≥ 25	0.40	0.10	Red	Red/Black
≥ 20	0.30	-	-	-
≥ 18	0.20	-	Green/ Yellow	-
≥ 14	0.10	-	-	-

Conditions:

- For safety relevant fastenings sufficient redundancy of the entire system is required: Minimum of 5 nails per fastened wood member. All visible setting failures must be replaced.
- Wood failure is not considered in recommended loads and must be assessed separately.
- Soft concrete up to $f_{c,cube} = 45 \text{ N/mm}^2$, Tough concrete up to $f_{c,cube} = 65 \text{ N/mm}^2$.
- Concrete with aggregate like granite or river rock or softer, and up to 16 mm diameter.
- To limit nail head penetration into wood or to increase pull-over load, use washer.

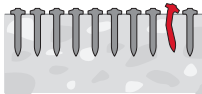

Stick rate estimation	
Soft Concrete	Tough Concrete (temporary fastenings only)
84% – 92%	80% – 90%

- The stick rate indicates the percentage of nails that were driven correctly to carry a load. Stick rate can vary from the above values depending on job site conditions.

Application requirements

Thickness of base material

$h_{min} = 80 \text{ mm}$

Permissible wood thickness

On soft concrete: $t_1 = 15 - 50 \text{ mm}$

On tough concrete: $t_1 = 15 - 40 \text{ mm}$

Edge distance and fastener spacing

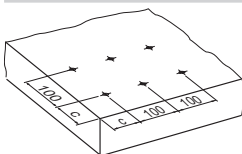

Edge distance:
Spacing:

$c \geq 70 \text{ mm}$
 $s \geq 100 \text{ mm}$

Fastener shank length (L_s) selection

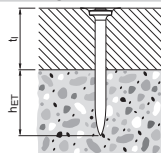
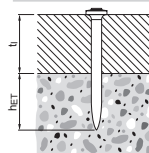

$L_s = h_{ET} + t_1$ [mm]

In case of flush fastenings:
 $L_s = h_{ET} + t_1 - 3$ [mm]

Fastening wood to steel base material

Recommended loads

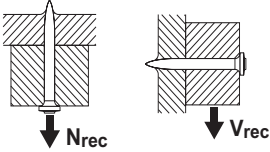

Base steel thickness	Recommended loads [kN]		Typical cartridge colour selection Type 6.8/11
	Tension N_{rec}	Shear V_{rec}	
10 mm	0.4	0.6	Red / Black
8 mm			Red
6 mm			Yellow / Red
4 mm			Green / Yellow

Conditions:

- For safety-relevant fastenings sufficient redundancy of the entire system is required.
- The recommended loads above are conservatively controlled by wood capacity determined in accordance with EN 1995. For a more detailed design of the wood member, EN 1995 must be considered.
- Observe nail edge distance and spacing in wood required by recognized standards (e.g. EN 1995)
- To limit nail head penetration into wood or to increase pull-over load, use washers.

Application requirements

Thickness of base material

Steel:

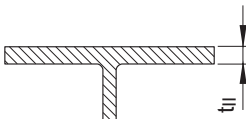

$$10 \text{ mm} \geq t_{II} \geq 4 \text{ mm}$$

Thickness of fastened material

Wood:

$$t_I = 15 - 50 \text{ mm}$$

Edge distance

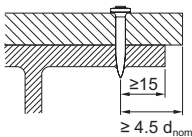

Fastener shank length (L_S) selection

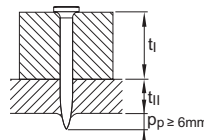

Application limits

For X-P 22 P8 to X-P 62 P8*

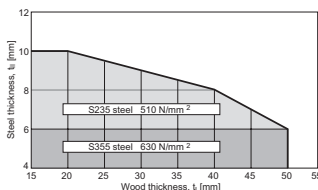

p_p = penetration of nail point through base steel

Nail shank length $L_S \sim t_I + t_{II} + 6 \text{ mm}$

For nail installation flush with wood surface:

Nail shank length $L_S \sim t_I + t_{II} + 3 \text{ mm}$

* On higher steel grades, fastening with single nails (P8) may yield better results (e.g. less shear brakes) than fastening with collated nails (MX) due to better nail guidance.

Corrosion information

Zinc-coated fasteners are not suitable for long-term service outdoors or in otherwise corrosive environments.

The use of certain wood species like Oak and Douglas Fir, as well as some wood treatments can require the use of stainless steel fasteners, independent of environmental conditions. The use of carbon steel fasteners is then not permitted. Please consider relevant local regulations.

For further detailed information on corrosion see chapter **Direct Fastening Principles and Technique**.

Fastening quality assurance

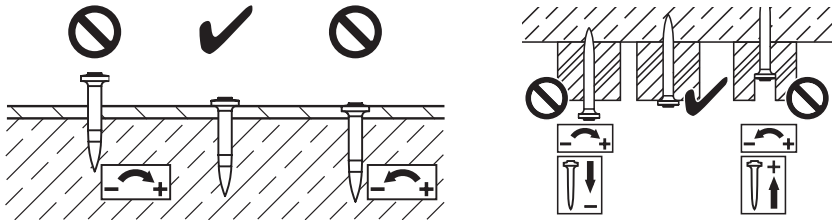

These are abbreviated instructions which may vary by application.

ALWAYS review / follow the instructions accompanying the product.

Fastener selection and system recommendation

Fastener program

Fastener	Item No.	L _s [mm]	DX 460 MX	DX 460 F8	DX 5 MX	DX 5 F8	DX 2, DX 36	DX 351 MX	DX 351 F8	DX 462 F8	Key applications
X-P 22 MX	2150380	22	■		■			■			Track or Wall Tie to concrete
X-P 27 MX	2150381	27	■		■			■			Track or Wall Tie to concrete
X-P 34 MX	2150382	34	■		■						Track or Wall Tie to concrete
X-P 40 MX	2150383	40	■		■						Wood to concrete & steel, Deflection Head
X-P 47 MX	2173900	47	■		■						Wood to concrete & steel, Deflection Head
X-P 52 MX	2173901	52	■		■						Wood to concrete & steel, Deflection Head
X-P 57 MX	2173902	57	■		■						Wood to concrete & steel, Deflection Head

■ = Recommended

■ = Feasible

Fastener	Item No.	L _S [mm]	DX 460 MX	DX 460 F8	DX 5 MX	DX 5 F8	DX 2, DX 36	DX 351 MX	DX 351 F8	DX 462 F8	Key applications
X-P 62 MX	2173903	62	■		■						Wood to concrete & steel, Deflection Head
X-P 72 MX	2173904	72	■		■						Wood to concrete, Deflection Head
X-P 22 P8	2150366	22		■		■	■		■	■	Track or Wall Tie to concrete
X-P 27 P8	2150367	27		■		■	■		■	■	Track or Wall Tie to concrete
X-P 34 P8	2150368	34		■		■	■		■	■	Track or Wall Tie to concrete
X-P 40 P8	2150369	40		■		■	■		■	■	Wood to concrete & steel, Deflection Head
X-P 47 P8	2173875	47		■		■	■		■	■	Wood to concrete & steel, Deflection Head
X-P 52 P8	2173876	52		■		■	■			■	Wood to concrete & steel, Deflection Head
X-P 57 P8	2173877	57		■		■	■			■	Wood to concrete & steel, Deflection Head
X-P 62 P8	2173878	62		■		■	■				Wood to concrete & steel, Deflection Head
X-P 72 P8	2173879	72		■		■	■				Wood to concrete, Deflection Head

■ = Recommended

■ = Feasible

X-C Nail for fastening to concrete and sand lime masonry

Product data

Dimensions

X-C __ P8

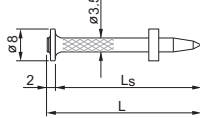

X-C __ MX

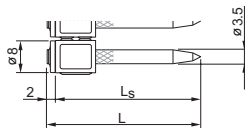

X-C __ P8S23

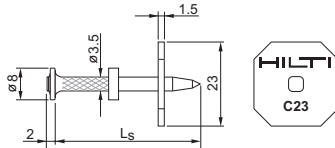

X-C __ P8S36

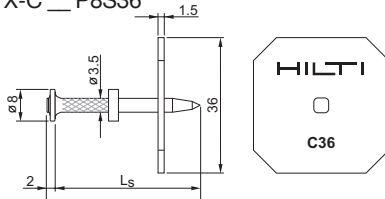

General information

Material specifications

Carbon steel shank: HRC 56.5
HRC 58 *)

Zinc coating: 5–20 μm

*) X-C 82, 97 and 117 P8 ($d_{\text{nom}} = 3.7 \text{ mm}$)

Recommended fastening tools

See **X-C fastener program** in the next pages and **Tools and equipment** chapter for more details.

X-C __ P8S23T (for tunneling applications)

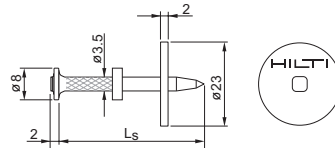

Applications

Examples

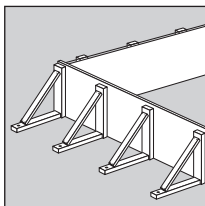

Conventional Formwork

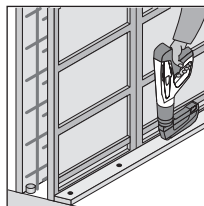

System Formwork

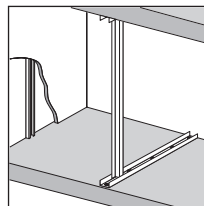

Drywall track to concrete

Load data

Recommended loads

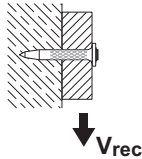
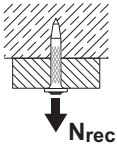

Fastening wood to concrete:

N_{rec} [kN]	V_{rec} [kN]	h_{ET} [mm]
0.4	0.4	≥ 27
0.3	0.3	≥ 22
0.2	0.2	≥ 18
0.1	0.1	≥ 14

Fastenings to sandlime masonry:

$N_{rec} = V_{rec} = 0.4 \text{ kN}$ for $h_{ET} \geq 27 \text{ mm}$

Design conditions:

- For safety relevant fastenings sufficient redundancy of the entire system is required: minimum 5 fastenings per fastened unit.
- All visible failures must be replaced.
- Valid for concrete with strength of $f_{cc} < 45 \text{ N/mm}^2$.
- Valid for predominantly static loading.
- Failure of the fastened material is not considered in recommended loads.
- To limit penetration of nail in soft material and to increase pullover load, use nails with washers.

Application requirements

Thickness of base and fastened material

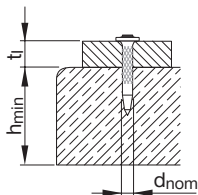

Concrete

$h_{min} = 80 \text{ mm}$

$t_1 \leq 50.0 \text{ mm}$

Edge distance and fastener spacing

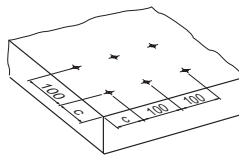

Edge distance:

Spacing:

$c \geq 70 \text{ mm}$

$s \geq 100 \text{ mm}$

Corrosion information

The intended use for safety relevant and permanent applications only comprises fastenings which are not directly exposed to external weather conditions or moist atmospheres.

Fastener selection and system recommendation

Fastener selection

Required nail shank length:

$$L_S = h_{ET} + t_1 \text{ [mm]}$$

Recommendation:

Concrete $h_{ET} = 22 \text{ mm}$

Sandlime masonry $h_{ET} = 27 \text{ mm}$

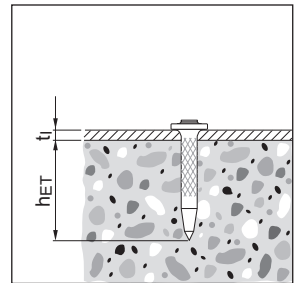
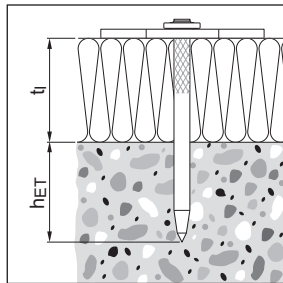
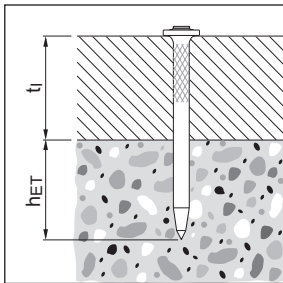

In case flush fastenings are required:
 $L_S = h_{ET} + t_1 - 5 \text{ [mm]}$

Fastener program

Nails					Tools							Key applications
Fastener description	Item no.		Specification		DX 460 MX, DX 5 MX	DX 460 F8, DX 5 F8	DX 2, DX 36	DX E72	DX 351 MX	DX 351 F8	DX 35	
	Packs of 1000 pcs	Packs of 100 pcs	L _s (mm)	d _{nom} (mm)								
X-C 22 P8	2091378	2091377	22	3.5	■	■	■			■	■	Thin metal part to concrete
X-C 27 P8	2091380	2091379	27	3.5	■	■	■			■	■	Thin metal part to concrete
X-C 32 P8	2091382	2091381	32	3.5	■	■	■			■	■	Thin metal part to concrete
X-C 37 P8	2091384	2091383	37	3.5	■	■	■			■	■	Thin metal part to concrete
X-C 42 P8	2091386	2091385	42	3.5	■	■	■			■		Soft mat / Wood on concrete
X-C 47 P8	2091388	2091387	47	3.5	■	■	■			■	■	Soft mat / Wood on concrete
X-C 52 P8	2091390	2091389	52	3.5	■	■	■					Wood on concrete
X-C 62 P8	2091392	2091391	62	3.5	■	■	■					Wood on concrete
X-C 72 P8		2091393	72	3.5	■	■	■					Wood on concrete
X-C 82 P8		360930	82	3.7	■	■	■					Wood on concrete (with pre-hammering)
X-C 97 P8		360931	97	3.7	■	■	■					Wood on concrete (with pre-hammering)
X-C 117 P8		360933	117	3.7	■	■	■					Wood on concrete (with pre-hammering)
X-C 20 THP	2091373	2091372	20	3.5	■	■	■			■	■	Thin metal part to concrete
X-C 22 P8 S15TH		2091410	22	3.5	■	■	■					Thin metal part to concrete
X-C 22 P8TH	2091374	2091375	22	3.5	■	■	■			■	■	Thin metal part to concrete
X-C 27 P8TH		2091376	27	3.5	■	■	■			■	■	Thin metal part to concrete
X-C 27 P8S23	2091396	2091395	27	3.5	■	■	■			■	■	High pull-over strength on concrete
X-C 32 P8S23	2091399	2091397	32	3.5	■	■	■			■	■	High pull-over strength on concrete
X-C 37 P8S23	2091401	2091400	37	3.5	■	■	■			■	■	High pull-over strength on concrete
X-C 42 P8S23	2091404	2091403	42	3.5	■	■	■			■		High pull-over strength on concrete
X-C 47 P8S23	2091406	2091405	47	3.5	■	■	■			■		High pull-over strength on concrete
X-C 37 P8S36	2091407		37	3.5	■	■	■			■	■	High pull-over strength on concrete
X-C 52 P8S36	2091408		52	3.5	■	■	■			■		High pull-over strength on concrete
X-C 62 P8S36	2091409		62	3.5	■	■	■					High pull-over strength on concrete
X-C 32 P8S23T	2091398		32	3.5	■	■	■					Tunneling applications
X-C 37 P8S23T	2091402		37	3.5	■	■	■					Tunneling applications

■ recommended
 ■ feasible

Nails				Tools							Key applications	
Fastener description	Item no.		Specifica-tion		DX 460 MX, DX 5 MX	DX 460 F8, DX 5 F8	DX 2, DX 36	DX E72	DX 351 MX	DX 351 F8		DX 35
	Packs of 1000 pcs	Packs of 100 pcs	L _s (mm)	d _{nom} (mm)								
X-C 20 MX	2091264	2091265	20	3.5	■							Thin metal part to concrete
X-C 27 MX	2091266	2091267	27	3.5	■				■			Thin metal part to concrete
X-C 32 MX	2091268	2091269	32	3.5	■							Thin metal part to concrete
X-C 37 MX	2091360	2091361	37	3.5	■							Thin metal part to concrete
X-C 42 MX	2091362	2091363	42	3.5	■							Soft material / Wood on concrete
X-C 47 MX	2091364	2091365	47	3.5	■							Soft material / Wood on concrete
X-C 52 MX	2091366	2091367	52	3.5	■							Wood on Concrete
X-C 62 MX	2091368	2091369	62	3.5	■							Wood on Concrete
X-C 72 MX	2091370	2091371	72	3.5	■							Wood on Concrete

MX: collated nails for magazine

■ recommended

Cartridge recommendation:

Green concrete: **6.8/11M green**

Normal concrete: **6.8/11M yellow**

Old/high strength concrete: **6.8/11M red**

Sandlime masonry: **6.8/11M green**

Tool energy adjustment by setting tests on site.

X-S Nail for fastening drywall track to steel

Product data

Dimensions

X-S13 THP

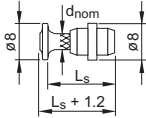

X-S16 P8TH

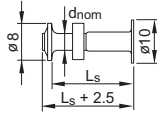

General information

Material specifications

Carbon steel shank:

X-S 16 P8 TH HRC 55.5

X-S 13 THP/MX HRC 52.5

Zinc coating: 5–13 μm

Recommended fastening tools

DX 460, DX 460 MX, DX 5, DX 5 MX, DX 36, DX 2, DX 351, DX 351 MX, DX-E 72

See **X-S fastener program** in the next pages and **Tools and equipment** chapter for more details.

Approvals

ICC (USA): **X-S (ESR-1752)**

Note: technical data presented in these approvals and design guidelines reflect specific local conditions and may differ from those published in this handbook.

Applications

Examples

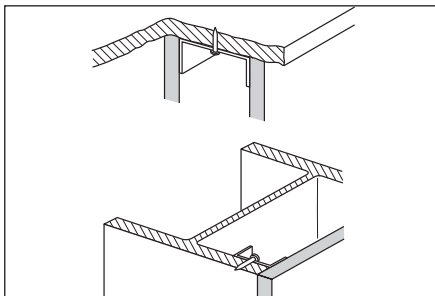

Drywall tracks to steel

Load data

Recommended loads

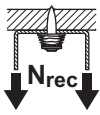

Steel 0.4 kN

Design conditions:

- Redundancy (multiple fastening) must be provided
- All visible failures must be replaced

Application requirements

Thickness of base material

Steel

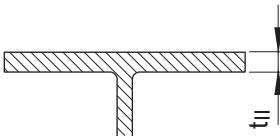

$t_{II} \geq 4 \text{ mm}$

Thickness of fastened material

Wooden track: $t_I \leq 24 \text{ mm}$

Metal track: $t_I \leq 2 \text{ mm}$

Edge distance

$c \geq 15 \text{ mm}$

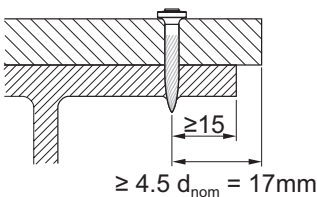

Corrosion information

The intended use only comprises fastenings which are not directly exposed to external weather conditions or moist atmospheres. For further detailed information on corrosion see corresponding chapter in **Direct Fastening Principles and Technique** section.

Application limits

Steel

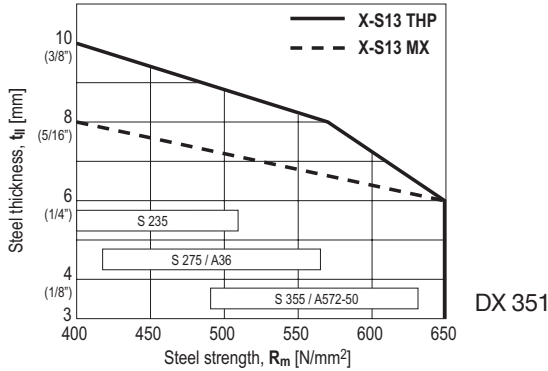

Fastener selection and system recommendation

Fastener selection

	Application	Base material
X-S 16	Metal track	Steel
X-S 13	Metal track	Steel

↑
increasing
strength

Fastener program

Fastener	Item no. Packs of 1000 nails	Item no. Packs of 100 nails	L_S [mm]	d_{nom} [mm]	Standard tools						
					DX 460 MX, DX 5 MX	DX 460 F8, DX 5 F8	DX 2, DX 36	DX E72	DX 351 MX	DX 351 F8	DX 35
X-S 13 THP	274061	274059	13	3.7		■	■	■		■	■
X-S 16 P8 TH	388842		16	3.7		■	■	■		■	■
X-S 13 MX	274062	274060	13	3.7	■				■		

Cartridge selection and tool energy setting

Cartridge recommendation:

6.8/11M yellow or red cartridge on steel thickness $t_{II} \geq 6$ mm

6.8/11M green or yellow cartridge on steel thickness $t_{II} < 6$ mm

Tool energy adjustment by setting tests on site.

Fastening quality assurance

Fastening inspection

Fastening to steel

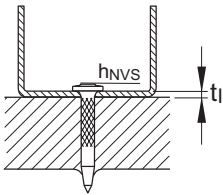

X-S: $h_{NVS} = 2-4$ mm

DS Heavy-duty nail for fastening to concrete and steel

Product data

Dimensions

DS __ P10

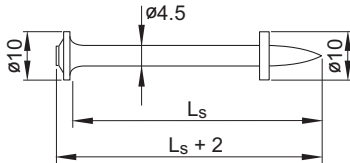

General information

Material specifications

Carbon steel shank: HRC 54 (**DS**)
HRC 58 (**DSH**)

Zinc coating: 5–20 μm

Recommended fastening tools

DX 460 F10, DX 5 F10, DX 76, DX 76 PTR

See **DS fastener program** in the next pages and **Tools and equipment** chapter for more details

Approvals

ICC (USA) LR 97/00077

Note:

Technical data presented in these approvals and design guidelines reflect specific local conditions and may differ from those published in this handbook.

Applications

Examples

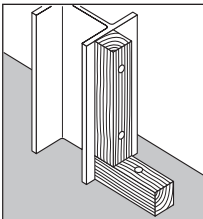

Wood to steel and concrete

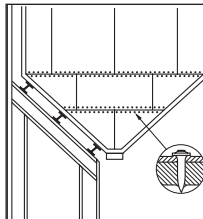

Plastic and rubber to steel

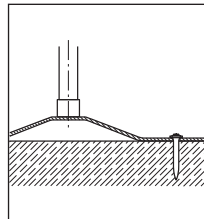

Metal parts to concrete

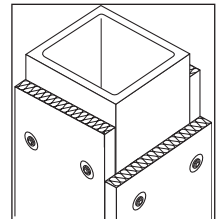

Soft material to steel and concrete

Load data

Recommended loads

Fastening wood to concrete, sandlime masonry or steel

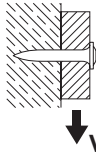
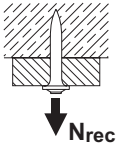

Fastening wood to concrete, sandlime masonry:

$$N_{rec} = V_{rec} = 0.4 \text{ kN}$$

Fastening wood to steel:

$$N_{rec} = V_{rec} = 0.6 \text{ kN}$$

Design conditions:

- For safety-relevant fastenings sufficient redundancy of the entire system is required: minimum 5 fastenings per fastened unit with normal weight concrete base material.
- All visible failures must be replaced.
- Valid for concrete and sandlime masonry with strength of $f_{cc} < 40 \text{ N/mm}^2$.
- Fastened material:

wood, minimum thickness	= 24 mm
plywood, minimum thickness	= 16 mm

Soft material:

- Working loads depend on strength and thickness of material fastened. Do not use working loads in excess of those for wood.
- Depth of penetration and other conditions same as for fastening wood.
- Use R23 or R36 ($\varnothing 4.5 \text{ mm}$ hole) washer to control penetration and to increase pull-over strength. Separately available from Hilti.

Metal profiles to concrete:

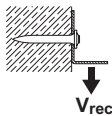
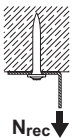

$$N_{rec} = V_{rec} = 0.4 \text{ kN}$$

- Minimum 5 fastenings per fastened unit (normal weight concrete)
- Increase to 600 N possible if 8 or more fastenings in each fastened unit.
- All visible failures must be replaced
- $t_1 = 1\text{--}4 \text{ mm}$

Application requirements

Thickness of base material

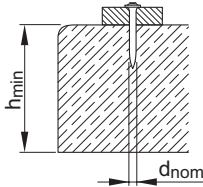

Concrete

$h_{min} = 100 \text{ mm}$ ($d_{nom} \geq 4.5 \text{ mm}$)

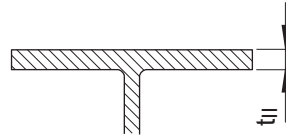

Steel

$t_l \geq 6 \text{ mm}$

Thickness of fastened material

$t_l \leq 50.0 \text{ mm}$

Spacing and edge distances (mm)

Edge distance: concrete

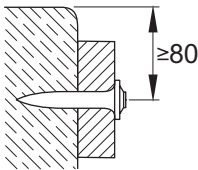

Edge distance: steel

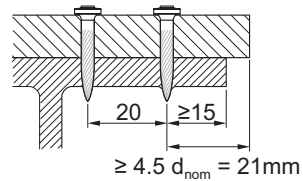

Spacing

$a = 20 \text{ mm}$

Corrosion information

The intended use for safety-relevant and permanent applications only comprises fastenings which are not directly exposed to external weather conditions or moist atmospheres. For further detailed information on corrosion see relevant chapter in **Direct Fastening Principles and Technique** section.

Application limits

Steel

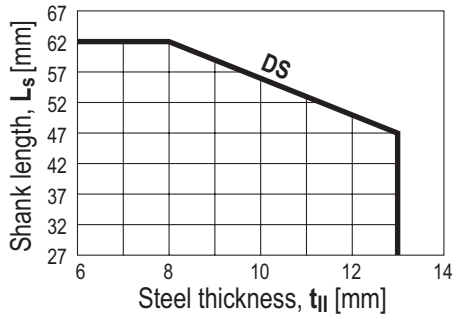

Fastener selection

Fastening to concrete

Required nail shank length:

Wood or

metal profiles $L_S = h_{ET} + t_I$ [mm]

Soft material $L_S = h_{ET} + t_I - 2 - h_{CS}$ [mm]

$h_{CS} \cong 3$ mm if possible

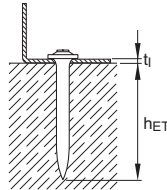

Required depth of penetration h_{ET}

Select h_{ET}

$h_{ET} \geq 27$ mm

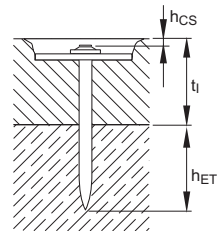
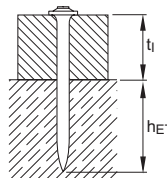

Fastening to steel

$h_{ET} = 17-27$ mm

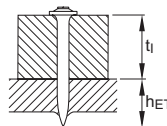

Fastener program

Fasteners

Designation	Item no.	L _S [mm]	d _{nom} [mm]
DS 27 P10	46157	27	4.5
DS 32 P10	46158	32	4.5
DS 37 P10	46159	37	4.5
DS 42 P10	46160	42	4.5
DS 47 P10	46161	47	4.5
DS 52 P10	46162	52	4.5
DSH 57 P10	40591	57	4.5
DS 62 P10	46164	62	4.5
DS 72 P10	46165	72	4.5

Nail length limits are for use without pre-driving into the wood. Hand-driving the nail into the wood and bringing the DX tool into position over the nail head extend the nail length range for the tools.

Cartridge selection and tool energy setting

Cartridge recommendation: DX 460, DX 5

Steel: **6.8/11M red cartridge**

Concrete: **6.8/11M yellow or red cartridge**

Masonry: **6.8/11M green cartridge**

Cartridge recommendation: DX 76, DX 76 PTR

Steel: **6.8/18M red or black cartridge**

Concrete: **6.8/18M yellow or red cartridge**

Tool energy adjustment by setting tests on site.

Fastening quality assurance

Fastening inspection

Fastening wood or soft material

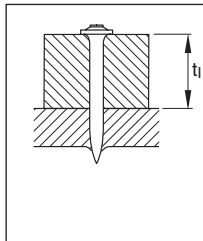
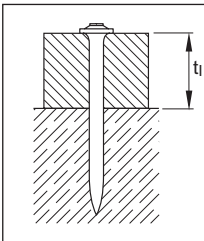

Fastening metal profiles

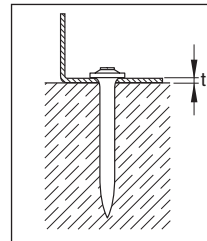

Flush setting of the nails

EDS Nail for fastening to steel

Product data

Dimensions

EDS_P10

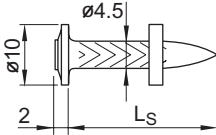

General information

Material specifications

Carbon steel shank:

EDS 19/22 HRC 55.0

EDS 27 HRC 53.5

Zinc coating: 10–25 μm

Recommended fastening tools

DX 76, DX 76 PTR

See **EDS fastener program** in the next pages and **Tools and equipment** chapter for more details.

Approvals

ICC (USA)

ABS, LR, DNV-GL

Note:

Technical data presented in these approvals and design guidelines reflect specific local conditions and may differ from those published in this handbook.



Applications

Example

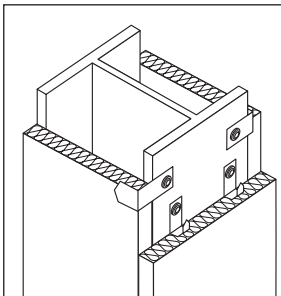

Metal clips

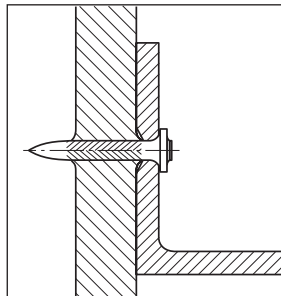

Angle bracket

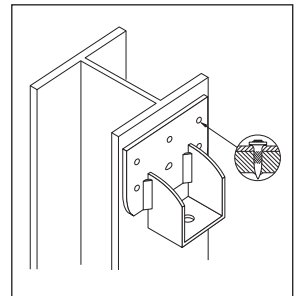

Mounting bracket

Load data

Recommended loads (predominantly static)

Steel sheet fastening

t_f [mm]	EDS_P10	
	N_{rec} [kN]	V_{rec} [kN]
0.75	1.1	1.5
1.00	1.3	2.3
1.25	1.7	3.2
≥ 2.00	2.4	4.0

- Recommended loads valid for steel sheet with minimum tensile strength ≥ 360 N/mm².
- For intermediate sheet thicknesses, use recommended load for next smaller thickness.
- N_{rec} and V_{rec} include an overall safety factor of 3.0 applied to the characteristic test data.
Static test: $N_{rec} = N_{test,k} / 3.0$, $V_{rec} = V_{test,k} / 3.0$

Forces of constraint

When fastening large pieces of steel, the possibility of shear loadings from forces of constraint should be considered. Avoid exceeding V_{rec} for the fastener shank!

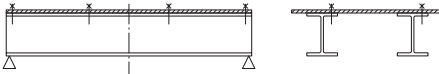

Deflection due to primary loading

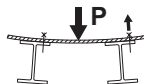
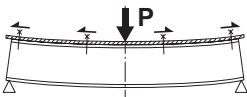

Temperature effect

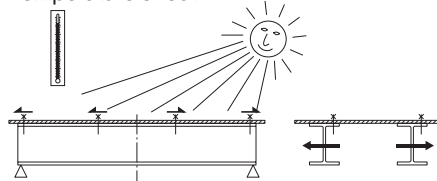

Application requirements

Thickness of base material

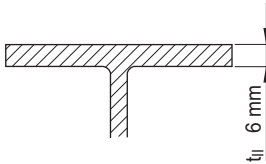

	t_{II} (mm)
EDS	≥ 6

Thickness of fastened material

$t_f \leq 3$ mm

Steel fastened material ≤ 3 mm thick, usually deforms with the displaced base material to allow a tight fit between fastened steel and base material without pre-drilling.

Because conditions may vary, trial fastenings are recommended

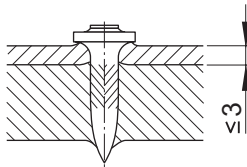

$t_f > 3$ mm

Without pre-drilling: steel fastened material > 3 mm thick is too stiff to deform entirely with the displaced base material. The gap, which increases with increasing t_f , can result in bending moments being applied to the nail shank.

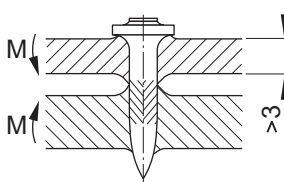

To prevent imposition of a moment on the shank of fastener, use three fasteners in a group.

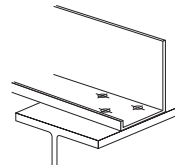

With pre-drilling:

If a gap between the fastened part and the base material is unacceptable, the fastened part can be prepared with drilled holes.

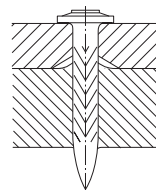
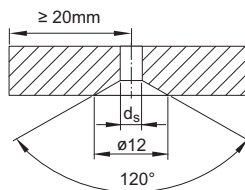

Spacing and edge distances (mm)

Base material

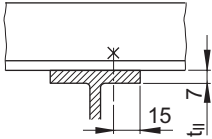

Fastened material

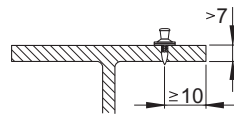
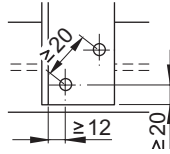

Corrosion information

The intended use only comprises fastenings which are not directly exposed to external weather conditions or moist atmospheres. For further detailed information on corrosion see relevant chapter in **Direct Fastening Principles and Technique** section.

Application limits

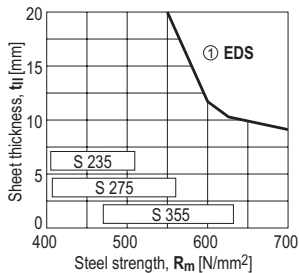

① EDS with DX76 and DX 76 PTR

- Limit line valid for steel, $t_1 \leq 3$ mm
- For steel $t_1 > 3$ mm and without pre-drilling, either make trial fastenings or adjust t_{II} to $t_{II} + t_1$ before using the chart.

Fastener program

Base material thickness	Fixed material thickness t_f [mm]									Fastener	Item no.	L_s [mm]	h_{ET} [mm]	DX tools
	≤1	2	3	5	6	7	8	9	13					
$t_{f,min} \geq 6$ mm	■	■	■	■						EDS 19 P10	46554	19	12-17	DX 76, DX76 PTR
				■	■	■	■			EDS 22 P10	46556	22	12-17	
								■	■	EDS 27 P10	46557	27	12-17	

■ recommended thickness

$L_s = h_{ET} + t_f$

Cartridge recommendation

Tool energy adjustment by setting tests on site

Fastener	Cartridge selection and tool energy setting
EDS	Cartridge recommendation: 6.8/18M red or black

Fastening quality assurance

Fastening inspection

EDS __ P10

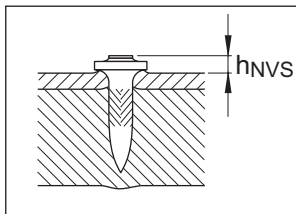

$h_{NVS} = 3.0-4.0$ mm

X-R Stainless steel nail for fastening to steel

Product data

Dimensions

X-R14 P8

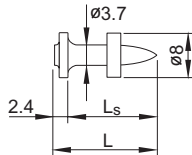

General information

Material specifications

Shank: P558 (CrMnMo alloy)
 $f_u \geq 2000 \text{ N/mm}^2$

Washer: polyethylene

Recommended fastening tools

DX 450, DX 460, DX 5

Applications

Examples

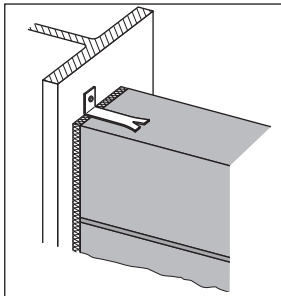

Steel to steel fastenings,
 e.g. wall ties, struts, channels,
 etc.

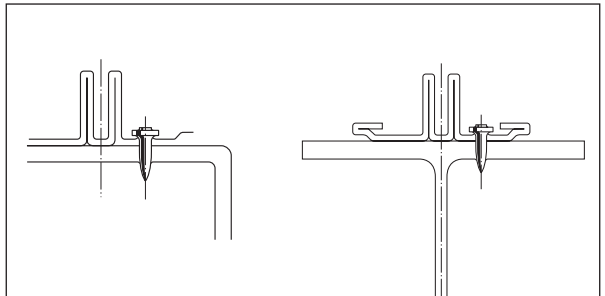

Fastening glass facade attachment profiles using the DX 450
 (125%, 8 mm narrow access)

Load data

Recommended loads

Carbon steel sheet, $f_u \geq 370$ N/mm ²			Aluminium sheet, $f_u \geq 210$ N/mm ²		
t_f [mm] ¹⁾	N_{rec} [kN]	V_{rec} [kN]	t_f [mm]	N_{rec} [kN]	V_{rec} [kN]
0.75	1.0	1.1	0.8	0.4	0.4
1.00	1.2	1.4	1.0	0.6	0.6
1.25	1.5	1.7	1.2	0.8	0.9
2.00	2.2	2.0	1.5	1.1	1.4
2.50	2.2	2.0	2.0	1.6	1.7
3.00	2.2	2.0			

1) Maximum thickness of attachment profiles in glass facade applications in accordance with DIBt approval Z-14.4-766: 2.5 mm.

Conditions:

- Recommended working loads valid for fastened materials as shown above.
- For intermediate sheet thicknesses, use recommended load for next smaller thickness.
- For stainless steel sheet, use same loads as for carbon steel sheet.
- Recommended loads include an overall safety factor applied to the characteristic strength.
Static test: $N_{rec} = N_{test,k} / 3.0$, $V_{rec} = V_{test,k} / 3.0$
- These recommended loads are appropriate for Eurocode 1 (or similar) wind loading designs.
- Forces of constraints must be observed, see section below.
- Resistances of glass facade attachment profiles: see DIBt approval Z-14.4-766

Forces of constraint

When fastening large pieces of steel or aluminium, the possibility of shear loading due to forces of constraint must be taken into account in the fastening design. Allowance must be made for movement or, alternatively, forces of constraint must be taken into account in the design and maximum shear force limited by way of V_{rec} .

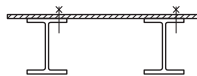
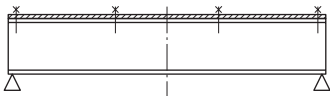

Deflection due to primary loading

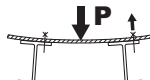
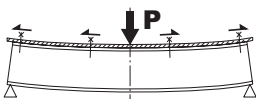

Temperature effect

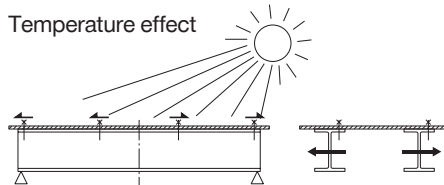

Application requirements

Thickness of base material

Using **DX 450** tool: $t_{II} \geq 5.0 \text{ mm}$ ¹⁾

¹⁾ $t_{II} \geq 4 \text{ mm}$ possible for specific types of rectangular hollow sections.

Please refer to DIBt approval for fastening glass facade attachment profiles using the DX 450.

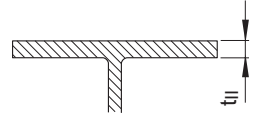

Using **DX 460, DX 5** tool: $t_{II} \geq 6.0 \text{ mm}$

Thickness of fastened material

Using **DX 460, DX 5** tool: $t_I \leq 1.0 \text{ mm}$

Using **DX 450** tool: $t_I \leq 3.0 \text{ mm}$

Spacing and edge distances (mm)

Rolled shapes

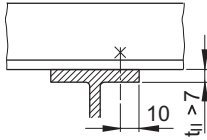

Cold-formed shapes

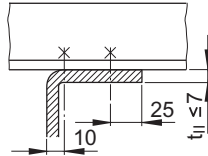

Fastened material

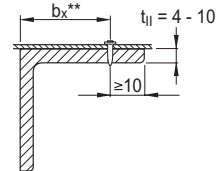
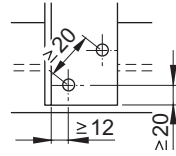

** max. allowable $b_x \leq 8 \times t_{II}$ (however, on-site trials advisable)

Corrosion information

For fastenings exposed to outdoor environments in mildly corrosive conditions where HDG coated parts are commonly specified or used.

Not for use in atmospheres with chlorides (marine atmospheres) or in heavily polluted environments (e.g. sulphur dioxide).

Application limits

DX 450

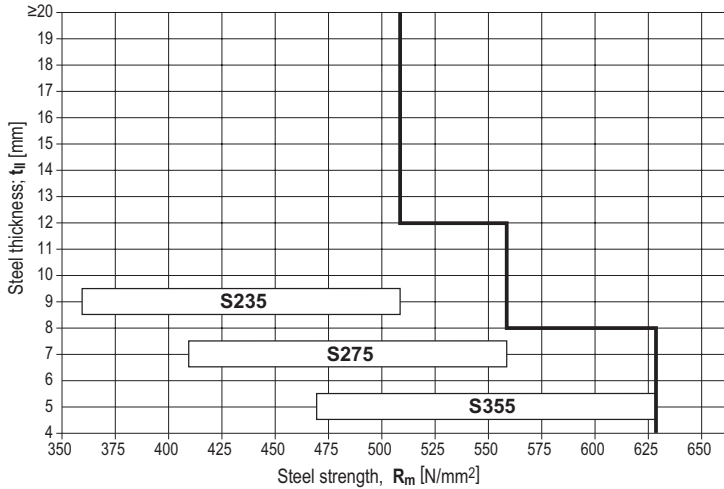

- Base material thickness 4 – 8 mm: covers base material steel grades up to grade S355
- Base material thickness 8 – 12 mm: covers base material steel grades up to grade S275
- Base material thickness > 12 mm: covers base material steel grade S235

DX 460, DX 5

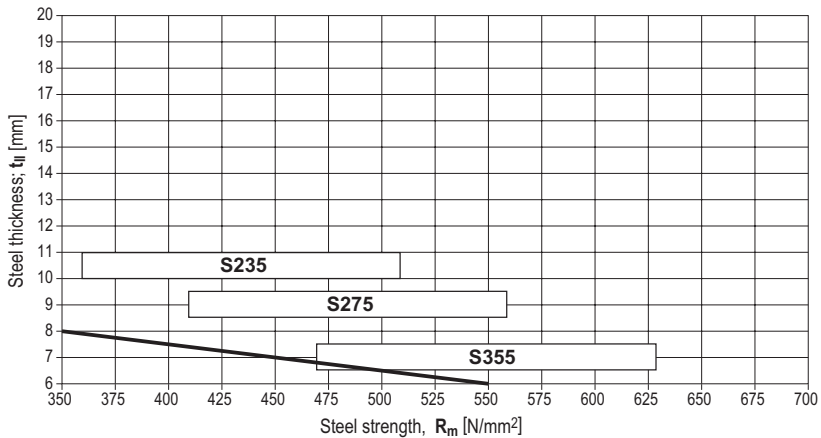

Fastener selection

Fastener program

Designation	Item no.	L_s [mm]	Tools
X-R14 P8	2122461	14	DX 450, DX 460, DX 5

Fastening quality assurance

Cartridge selection, tool energy setting and fastening inspection

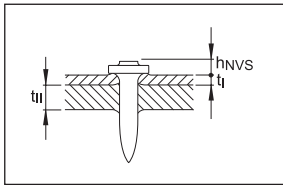

DX 450

Base material thickness [mm] t_{II}	4 - 6	6 - 8	> 8
Cartridge, 6.8/11M	Yellow	Red	
Tool energy setting	1.0 – 3.0	2.0 – 3.0	2.5 – 3.0
h_{NVS} [mm]	3.0 – 4.5	3.0 – 4.5	2.0 – 3.0

DX 460, DX 5

Cartridge, 6.8/11M	Red
h_{NVS} [mm]	3.0 – 4.5

Tool energy adjustment by setting tests on site

X-CR Stainless steel nail for fastening to steel

Product data

Dimensions

X-CR __ P8

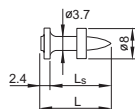

X-CR 14 D12

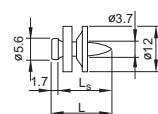

X-CR __ S12

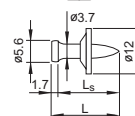

General information

Material specifications

Nail shank: CR-500 (CrNiMo alloy)

$f_u \geq 1800 \text{ N/mm}^2$

Steel washers: X2CrNiMo 18143

Plastic washers: polyethylene

Recommended fastening tools

DX 460, DX 5, DX 450

See **X-CR fastener program** in the next pages and **Tools and equipment** chapter for more details.

Approvals

DIBt (Germany): X-CR 14 P8
fastening of glass facades
with DX 450 (125%)

ABS, LR: all types



Applications (for fastenings exposed to weather or other corrosive conditions)

Examples

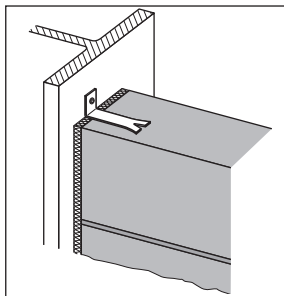

Wall ties

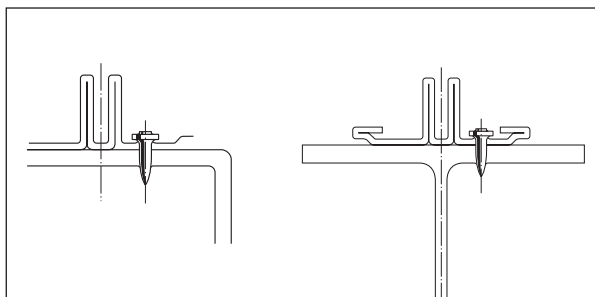

Fastening of glass facades

Load data

Recommended loads

Steel sheet fastening

Carbon steel sheet, $f_u \geq 370 \text{ N/mm}^2$

Aluminium sheet, $f_u \geq 210 \text{ N/mm}^2$

t_f [mm]	X-CR __ P8		X-CR __ D12/S12		t_f [mm]	X-CR __ P8		X-CR __ D12/S12	
	N_{rec} [kN]	V_{rec} [kN]	N_{rec} [kN]	V_{rec} [kN]		N_{rec} [kN]	V_{rec} [kN]	N_{rec} [kN]	V_{rec} [kN]
0.75	1.0	1.1	1.4	1.1	0.8	0.4	0.4	0.6	0.4
1.00	1.2	1.4	1.6	1.4	1.0	0.6	0.6	0.8	0.6
1.25	1.5	1.7	1.8	1.7	1.2	0.8	0.9	1.1	0.9
2.00	2.2	2.0	2.2	2.0	1.5	1.1	1.4	1.6	1.4
					2.0	1.6	1.7	1.9	1.7

- Recommended working loads valid for fastened materials as shown above.
- For intermediate sheet thicknesses, use recommended load for next smaller thickness.
- For stainless steel sheet, use same loads as for carbon steel sheet.
- Recommended loads include an overall safety factor applied to the characteristic strength.
Static test: $N_{rec} = N_{test,k} / 3.0$ $V_{rec} = V_{test,k} / 3.0$
- These recommended loads are appropriate for Eurocode 1 (or similar) wind loading designs.

Other applications*

X-CR __ P8 / X-CR 14 D12 / X-CR __ S12

N_{rec} [kN]	X-CR __ P8	
	V_{rec} [kN]	M_{rec} [Nm]
1.6	2.0	3.8

* Fastened parts: thicker steel components (clips, brackets, etc.)

- Failure of fastened material is not considered in N_{rec} and V_{rec} .
- Loads valid for predominantly static loading.

Forces of constraint

When fastening large pieces of steel or aluminium, the possibility of shear loadings from forces of constraint should be considered in the fastening design. Either allow for movement or avoid exceeding V_{rec} !

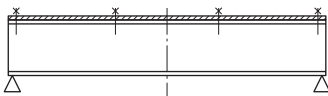

Deflection due to primary loading

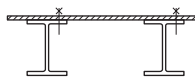

Temperature effect

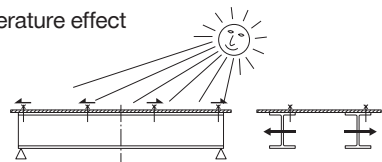
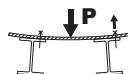
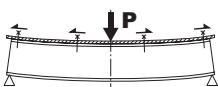

Application requirements

Thickness of base material

Using **DX 450** tool: $t_{II} \geq 5.0 \text{ mm}$ ¹⁾
 Using **DX 460, DX 5** tool: $t_{II} \geq 6.0 \text{ mm}$

¹⁾ $t_{II} \geq 4 \text{ mm}$ possible for specific types of hollow sections

Thickness of fastened material

$t_I \leq 12.0 \text{ mm}$ (details see fastener selection)

Spacing and edge distances (mm)

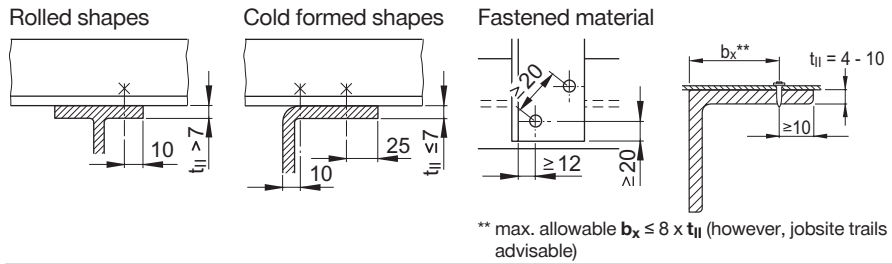

Corrosion information

For fastenings exposed to weather or other corrosive conditions. Not for use in highly corrosive surroundings like swimming pools or highway tunnels.
 For further detailed information on corrosion see relevant chapter in **Direct Fastening Principles and Technique** section.

Application limits

DX 450, DX 460, DX 5

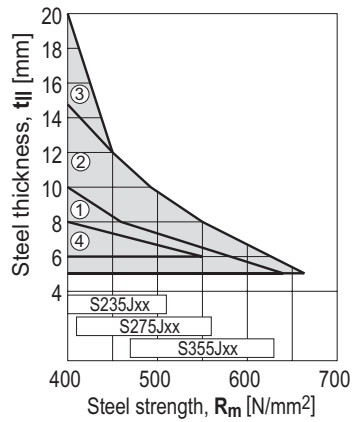

- ① **X-CR16** ($t_I \leq 3 \text{ mm}$) with DX 450 tool
- ② **X-CR14** ($t_I \leq 2 \text{ mm}$) with DX 450 tool
- ③ **X-CR14** ($t_I \leq 1 \text{ mm}$) with DX 450 tool
- ④ **X-CR14** ($t_I \leq 1 \text{ mm}$) with DX 460, DX 5 tool

DX 450: Steel thickness $t_{II} \geq 5 \text{ mm}$
DX 460, DX 5: Steel thickness $t_{II} \geq 6 \text{ mm}$

Fastener program

Fastening of steel sheets

Fixed material thickness t_l [mm]			Fastener Designation	Item no.	L_s [mm]	h_{ET} [mm]	Tool
≤1	2	3					
		■	X-CR 16 P8	247356	16	≥ 9	DX 450, DX 460, DX 5
■			X-CR 14 D12	244601	14	≥ 9	DX 450
	■	■	X-CR 16 S12	298855	16	≥ 9	DX 450

Fastening of wood or soft material

Fixed material thickness t_l [mm]						Fastener Designation	Item no.	L_s [mm]	h_{ET} [mm]	Tool
≤4	5	6	8	9	11					
	■	■				X-CR 18 P8	247357	18	≥ 9	DX 450, DX 460, DX 5
			■	■		X-CR 21 P8	247358	21	≥ 9	DX 450, DX 460, DX 5
■	■					X-CR 18 S12	298856	18	≥ 9	DX 450
		■	■			X-CR 21 S12	298857	21	≥ 9	DX 450
				■	■	X-CR 24 S12	298858	24	≥ 9	DX 450

■ = recommended thickness

$$L_s = h_{ET} + t_l$$

for X-CR __P8

$$L_s = h_{ET} + t_l + 1$$

for X-CR __D12/S12

Cartridge recommendation

DX 460, DX 5 **6.8/11M red or black cartridge**

DX 450 **6.8/11M yellow cartridge** ($t_{ll} \geq 5-6$ mm)

6.8/11M red cartridge ($t_{ll} > 6$ mm)

Tool energy adjustment by setting tests on site.

Fastening quality assurance

Fastening inspection

X-CR __ P8

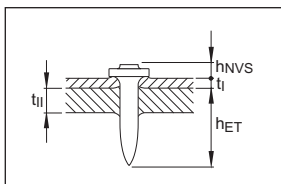

$h_{NVS} = 3.0-4.5$ mm

X-CR 14 D12

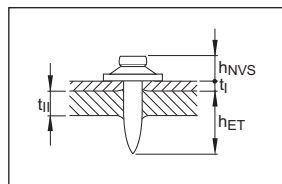

$h_{NVS} = 4-5$ mm

X-CR __ S12

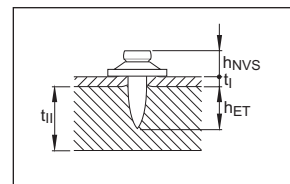

$h_{NVS} = 4-5$ mm

X-CR Stainless steel nail for fastening to concrete, sand lime masonry and steel

Product data

Dimensions

X-CR __ P8

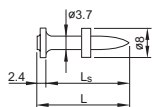

X-CR __ P8

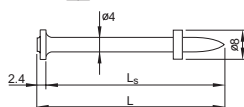

X-CR __ P8 S12

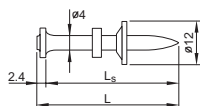

X-CR_P8 S15

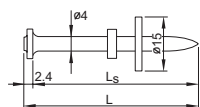

General information

Material specifications

Nail shank: CrNiMo Alloy
 $f_u \geq 1800 \text{ N/mm}^2$
 (49 HRC)

Zinc coating: X-CR 48/52 P8 S15 has
 5–13 μm

Zinc coating to improve anchorage in concrete

Recommended fastening tools

DX 460, DX 5, DX 36, DX 2, DX-E72

See **X-CR fastener program** in the next pages and **Tools and equipment** chapter for more details

Approvals

ABS, LR: all types



Applications

Examples

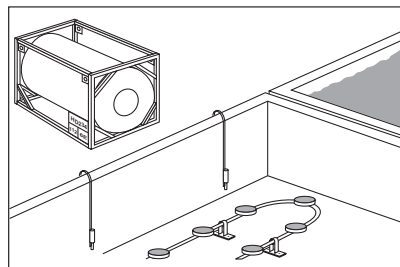

Exposure to weather or otherwise corrosive conditions

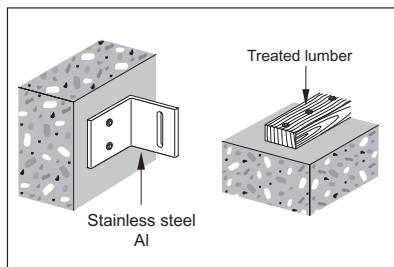

Noble or corrosive fastened material

Load data

DX Standard: Recommended loads

Fastening wood to concrete, sandlime masonry or steel

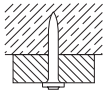

N_{rec}



V_{rec}

Fastening wood to concrete, sandlime masonry:

$$N_{rec} = V_{rec} = 0.4 \text{ kN}$$

Fastening wood to steel:

$$N_{rec} = V_{rec} = 0.6 \text{ kN}$$

Design conditions:

- For safety relevant fastenings sufficient redundancy of the entire system is required: minimum 5 fastenings per fastened unit with normal weight concrete base material.
- All visible failures must be replaced.
- Valid for concrete and sandlime masonry with strength of $f_{cc} < 40 \text{ N/mm}^2$.
- Valid for predominantly static loading.

Soft material:

- Working loads depend on strength and thickness of material fastened. Do not use working loads in excess of those for wood.
- Depth penetration and other conditions same as for fastening wood
- Use R23 or R36 ($\varnothing 4.5 \text{ mm}$ hole) washer to control penetration and to increase pull-over strength. Separately available from Hilti.

DX-Kwik (with pre-drilling): Recommended loads

	$N_{rec,1}$ [kN]	$N_{rec,2}$ [kN]	V_{rec} [kN]	M_{rec} [Nm]
X-CR 39/44	2.0	0.6	2.0	5.5
X-CR 48	3.0	0.9	3.0	5.5

Conditions:

- $N_{rec,1}$: concrete in compressive zone.
- $N_{rec,2}$: concrete in tension zone.
- Static or cyclic (5000 load applications) loading.
- $f_{cc} \geq 25 \text{ N/mm}^2$. For higher concrete strengths, higher loadings may be possible if supported by testing.
- A sufficient redundancy has to be ensured, that the failure of a single fastening will not lead to collapse of the entire system.
- Recommended loads are based on failure of the fastener anchorage in the concrete. Thickness and quality of the fastened material may lower the loadings.
- Observance of all pre-drilling requirements, fastened thickness limits, and recommended details.

Application requirements

Thickness of base material

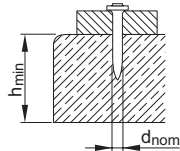

Concrete
 $h_{min} = 80 \text{ mm}$ ($d_{nom} = 3.7 \text{ mm}$)
 $h_{min} = 90 \text{ mm}$ ($d_{nom} \geq 4.0 \text{ mm}$)

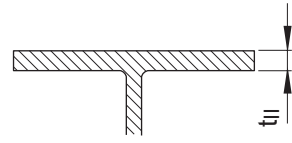

Steel
 $t_{II} \geq 5 \text{ mm}$ for fastening of wood

Thickness of fastened material

$t_1 \leq 25.0 \text{ mm}$ (detailed information see fastener selection)

Spacing and edge distances (mm)

Pairs

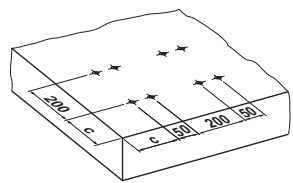

	reinforced*	non-reinforced
c	100	150

Row along edge

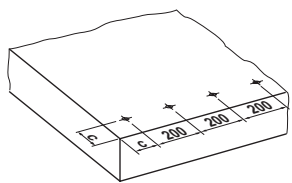

	reinforced*	non-reinforced
c	80	150

General
(e.g. group of fasteners)

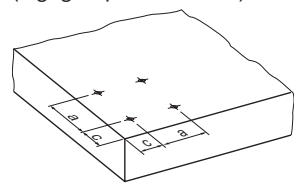

	reinforced*	non-reinforced
c	80	150
a	80	100

* Minimum $\varnothing 6 \text{ mm}$ reinforcing steel continuous along all edges and around all corners. Edge bar must be enclosed by stirrups.

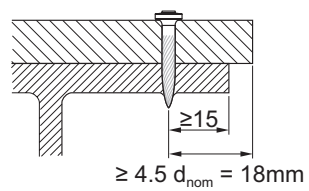

Corrosion information

For fastenings exposed to weather or other corrosive conditions. Not for use in highly corrosive surroundings like swimming pools or highway tunnels.

For further detailed information on corrosion see relevant chapter in **Direct Fastening Principles and Technique** section.

Application limits

Steel

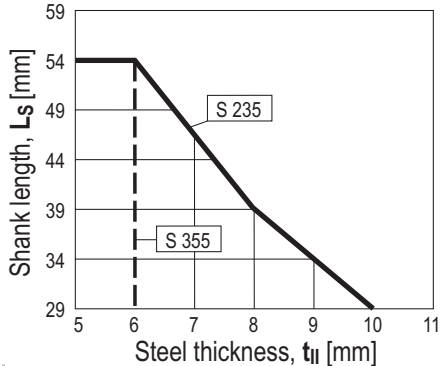

Fastener selection

DX Standard – fastening wood or soft material

Required nail shank length

Wood: $L_s = h_{ET} + t_t$ [mm]

Soft material: $L_s = h_{ET} + t_t - 2.4 - h_{CS}$ [mm]

$h_{CS} \approx 3$ mm if possible

Required depth of penetration h_{ET}

Normal weight concrete NWC

h_{ET} according to concrete strength f_{cc}

f_{cc} [N/mm ²]	15	25	35
h_{ET} [mm]	32	27	22

h_{ET} [mm]	32	27	22
---------------	----	----	----

Light weight concrete LWC:

$h_{ET} = 32-37$ mm

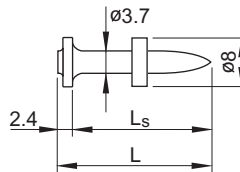

Sandlime masonry SLM

h_{ET} according to concrete strength f_{cc}

f_{cc} [N/mm ²]	15	25	35
h_{ET} [mm]	32	27	27

h_{ET} [mm]	32	27	27
---------------	----	----	----

Steel

$h_{ET} \geq 10$ mm

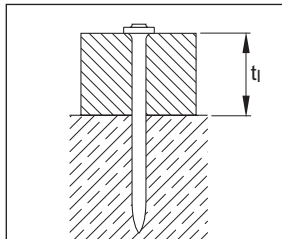

Normal weight concrete NWC

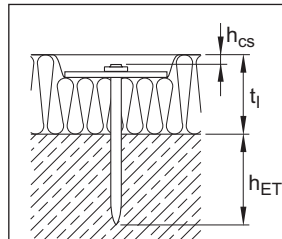

Sandlime masonry SLM

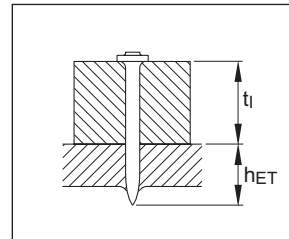

Steel

Fastener program

Fasteners				Tool
Designation	Item no	L _S [mm]	d _{nom} [mm]	Designation
X-CR 24 P8	247359	24	3.7	DX 460, DX 5, DX 36, DX 2, DX-E 72 ¹⁾
X-CR 29 P8	247360	29	3.7	DX 460, DX 5, DX 36, DX 2, DX-E 72 ¹⁾
X-CR 34 P8	247361	34	3.7	DX 460, DX 5, DX 36, DX 2, DX-E 72 ¹⁾
X-CR 39 P8	247362	39	4.0	DX 460, DX 5, DX 36, DX 2, DX-E 72 ¹⁾
X-CR 44 P8	247363	44	4.0	DX 460, DX 5, DX 36, DX 2, DX-E 72 ¹⁾
X-CR 54 P8	247429	54	4.0	DX 460, DX 5, DX 36, DX 2, DX-E 72 ¹⁾
X-CR 39 P8 S12	247354	39	4.0	DX 460, DX 5, DX 36, DX 2 ²⁾
X-CR 44 P8 S12	247355	44	4.0	DX 460, DX 5, DX 36, DX 2 ²⁾
X-CR 48 P8 S15	258121	48	4.0	DX 460, DX 5, DX 36, DX 2 ²⁾
X-CR 52 P8 S15	2052687	52	4.0	DX 460, DX 5

Method: ¹⁾ **DX Standard** (without pre-drilling)

²⁾ **DX-Kwik** (with pre-drilling)

Cartridge selection

DX Standard

Steel: **6.8/11M yellow, red or black cartridge**

Concrete: **6.8/11M yellow or red cartridge**

Masonry: **6.8/11M green cartridge**

DX-Kwik

Concrete: **6.8/11M yellow or red or black cartridge**

Tool energy adjustment by setting tests on site.

Fastening quality assurance

Installation instruction

DX-Kwik

Pre-drilling details (not through fastened material)

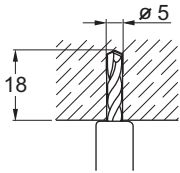

X-CR 39 / X-CR 44

Fastener	t_f [mm]	Drill bit	Item no
X-CR 39	≤ 2	TX-C-5/18	00061793
X-CR 44	2-7	TX-C-5/18	

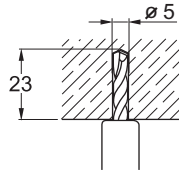

X-CR 48 / X-CR 52

Fastener	t_f [mm]	Drill bit	Item no
X-CR 48	≤ 5	TX-C-5/23	00061787
X-CR 52	5-9	TX-C-5/23	00061787

Details valid for C20/25 – C45/55 ($f_{cc} = 25-55 \text{ N/mm}^2$ / $f_c = 20-45 \text{ N/mm}^2$)

Pre-drilling details (through fastened material)

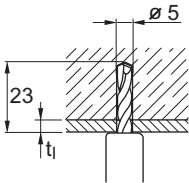

X-CR 48

Fastener	t_f [mm]	Drill bit	Item no
X-CR 48	≤ 2	TX-C-5/23	00061787

Details valid for C20/25 – C50/60

These are abbreviated instructions which may vary by application.

ALWAYS review/follow the instructions accompanying the product.

X-CT Nail for forming or other temporary use

Product data

Dimensions

X-CT __ MX, X-CT __ DP8

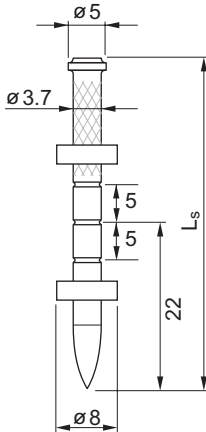

General information

Material specifications

Carbon steel shank: HRC 53

Zinc coating: 5–20 μm

Recommended fastening tools

DX 460-F8, DX 460 MX, DX 5-F8, DX 5 MX, DX 36, DX 2, DX-E72

See **X-CT fastener program** in the next pages and **Tools and equipment** chapter for more details.

Applications

Examples

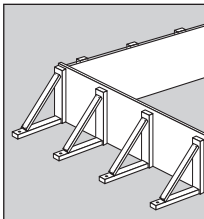

Conventional Formwork

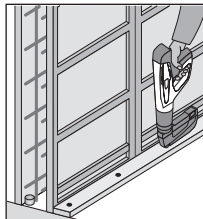

System Formwork

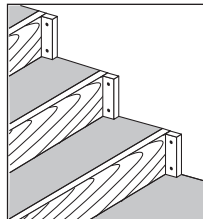

To position and hold concrete formwork

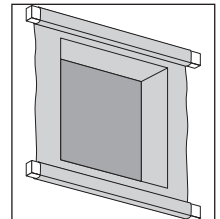

Fasten plastic, netting, etc.

Load data

Recommended loads

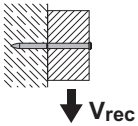

$$V_{rec} = 0.3 \text{ kN for } h_{ET} \geq 22 \text{ mm}$$

Conditions:

- Static loading only (placing and vibration of concrete does not affect design).
- Minimum 5 fastenings per fastened unit.

Application requirements

Thickness of base and fastened material

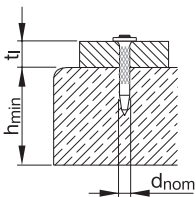

$$h_{min} = 80 \text{ mm}$$

$$t_1 = 20\text{--}50 \text{ mm}$$

Edge distances

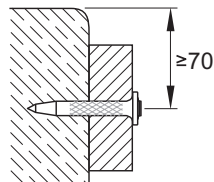

Edge distances $c \geq 70 \text{ mm}$

Fastener selection and system recommendation

Fastener selection

Required nail shank length:

$$L_S = h_{ET} + t_1 \text{ [mm]}$$

Recommendation:

Concrete

$$h_{ET} = 22 \text{ mm}$$

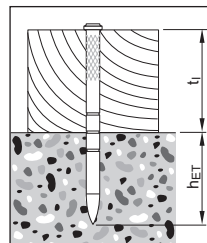

Fastener program

Fasteners					Tools				Key applications
Designation	Item no. Packs of 1000 nails	100 nails	L _s [mm]	d _{nom} [mm]	DX-460 MX, DX-5 MX	DX-460 FR, DX-5 FB	DX-2, DX-36	DX-EF2	
X-CT 47 MX	383588		47	3.7	■				Wood to concrete
X-CT 52 MX	383589	383576	52	3.7	■				Wood to concrete
X-CT 62 MX	383591	383579	62	3.7	■				Wood to concrete
X-CT 72 MX		383580	72	3.7	■				Wood to concrete
X-CT 47 DP8		383582	47	3.7		■	■	■	Wood to concrete
X-CT 52 DP8		383583	52	3.7		■	■	■	Wood to concrete
X-CT 62 DP8		383585	62	3.7		■	■	■	Wood to concrete
X-CT 72 DP8		383586	72	3.7		■	■	■	Wood on concrete (with pre-hammering)
X-CT 97 DP8		383587	97	3.7		■	■	■	Wood on concrete (with pre-hammering)

■ recommended
■ feasible

Cartridge recommendation:

 Green concrete: **6.8/11M green**

 Normal concrete: **6.8/11M yellow**

DX-Kwik X-M6 H, X-M8 H and DNH, X-DKH Threaded stud and nail

Product data

Dimensions

X-M6H-__-37 FP8

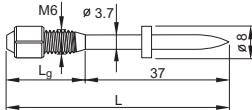

X-M8H-__-37 P8

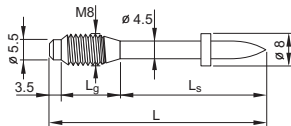

DNH 37 P8S15

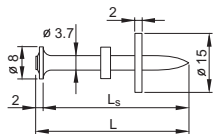

X-DKH 48 P8S15

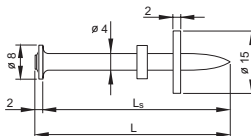

General information

Material specifications

Carbon steel shank: HRC 58
Zinc coating: 5–20 µm

Recommended fastening tools

DX 460, DX 5, DX 36, DXE-72

See **DX-Kwik fastener program** in the next pages and **Tools and equipment** chapter for more details.

Approvals

IBMB 3041/8171 X-M8H, X-DKH, X-M6H
DIBt (Germany): X-M8H

Note:
Technical data presented in these approvals and design guidelines reflect specific local conditions and may differ from those published in this handbook.

Applications

Examples

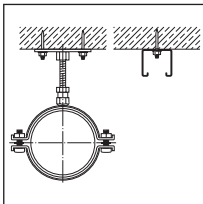

Base plates,
rails for piping

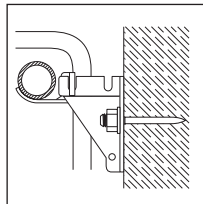

Radiator brackets

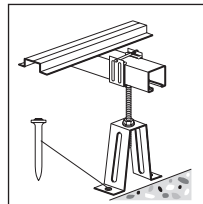

Floor stands, metal
fixtures to concrete

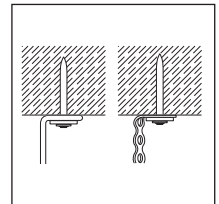

Suspended ceilings

Load data

Recommended loads

	$N_{rec,1}$ [kN]	$N_{rec,2}$ [kN]	$V_{rec,1}$ [kN]	$M_{rec,1}$ [Nm]
X-M6H, DNH 37	2.0	0.6	2.0	5.5
X-M8H, X-DKH 48	3.0	0.9	3.0	10.0

Conditions

- $N_{rec,1}$: concrete in compressive zone.
- $N_{rec,2}$: concrete in tension zone.
- Predominantly static loading.
- Concrete C20/25–C50/60.
- A sufficient redundancy has to be ensured, that the failure of a single fastening will not lead to collapse of the entire system.
- Recommended loads are based on failure of the fastener anchorage in the concrete. Thickness and quality of the fastened material may lower the loadings.
 - Observance of all pre-drilling requirements, fastened thickness limits, and recommended details.
 - The recommended loads in the table refer to the resistance of the individual fastening and may not be the same as the loads F_N and F_V acting on the fastened part.

Note: If relevant, prying forces need to be considered in design, see example. Moment acting on fastener shank only in case of a gap between base and fastened material.

Arrangements to prevent moment on shank:

Coupler tight against concrete

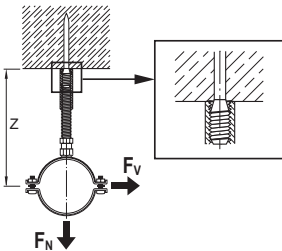

Non-symmetric arrangement

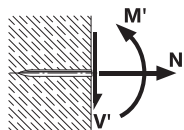
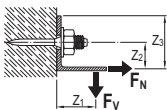

Resultant forces on nail

- Moment on fastened part
- Prying effect must be considered in determining loads acting on fastener

Application requirements

Thickness of base material

X-M6H, DNH 37: $h_{\min} = 100 \text{ mm}$

X-M8H, X-DKH 48: $h_{\min} = 100 \text{ mm}$

Thickness of fastened material

X-M6H: $t_1 \leq L_g - t_{\text{washer}} - t_{\text{nut}} \cong \text{up to } 13.5 \text{ mm}$

X-M8H: $t_1 \leq L_g - t_{\text{washer}} - t_{\text{nut}} \cong \text{up to } 14.0 \text{ mm}$

DNH 37: $t_1 \leq 2.0 \text{ mm}$

X-DKH 48: $t_1 \leq 5.0 \text{ mm}$ or $t_1 \leq 2.0$ by pre-drilling through fastened material

Spacing and edge distances (mm)

Pairs

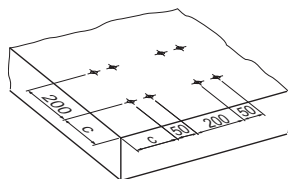

	Reinforced	Non-reinforced
c	100	150

Row along edge

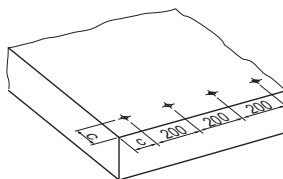

	Reinforced	Non-reinforced
c	80	150

General (e.g. group of fasteners)

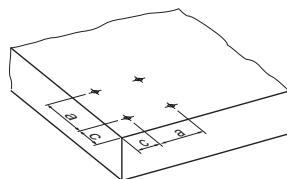

	Reinforced	Non-reinforced
c	80	150
a	80	100

Corrosion information

The intended use only comprises fastenings which are not directly exposed to external weather conditions or moist atmospheres. For further detailed information on corrosion see relevant chapter in **Direct Fastening Principles and Technique** section.

Fastener program

Fastened thickness $t_{i,max}$ [mm]	Fastener				
	Designation	Item no.	L_g [mm]	L_s [mm]	L [mm]
-	X-M6H-10-37 FP8	40464	10	37	47
-	X-M8H-10-37 P8	20059	10	37	50.5
5.0	X-M8H/5-15-37 P8	26325	15	37	55.5
15.0	X-M8H/15-25-37 P8	20064	25	37	65.5
2.0	DNH 37 P8S15	44165	-	37	39
5.0*	X-DKH 48 P8S15	40514	-	48	50

*) with pre-drilling through fastened material $t_{i,max} = 2.0$ mm

Tools, cartridge selection and tool energy setting

DX 460, DX 5, DX 36, DXE-72: 6.8/11M yellow or red cartridge

Tool energy adjustment by setting tests on site.

Fastening quality assurance

Fastening inspection

X-M6H, X-M8H

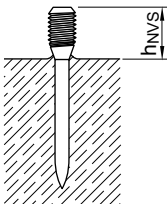

$$h_{NVS} = L - h_{ET}, \quad h_{ET} = 37-41 \text{ mm}$$

DNH 37, X-DKH 48

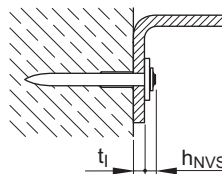

$$h_{NVS} = 4 \text{ mm}$$

Place nails so that heads and washers bear tightly against each other and against the fastened material

Installation

X-M6H, X-M8H

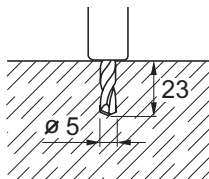

Pre-drill with drill bit

Designation	Item no
-------------	---------

TX-C-5/23B	28557
-------------------	-------

or

TX-C-5/23	61787
------------------	-------

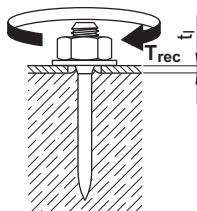

Tightening torque

Designation	T _{rec} [Nm]
-------------	-----------------------

X-M6H	6.5
--------------	-----

X-M8H	10.0
--------------	------

DNH 37, X-DKH 48

Pre-drilling details (not through fastened material)

DNH 37

t ₁ [mm]	Drill-bit	Item no.
≤ 2	TX-C-5/18	61793

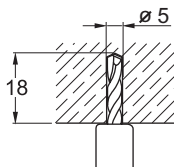

X-DKH 48

t ₁ [mm]	Drill-bit	Item no.
≤ 5	TX-C-5/23B	28557

or

TX-C-5/23	00061787
------------------	----------

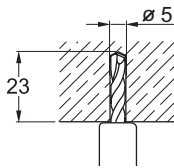

Details valid for C20/25–C50/60

Pre-drilling details (through fastened material)

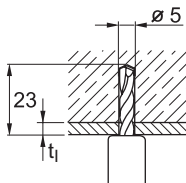

X-DKH 48

t ₁ [mm]	Drill-bit	Item no.
≤ 2	only TX-C5/23	61787

Details valid for C20/25–C50/60

These are abbreviated instructions which may vary by application.

ALWAYS review/follow the instructions accompanying the product.

X-M6, X-W6, X-M8, M10, W10

Threaded stud for fastening to concrete

Product data

Dimensions

X-M6/W6 ____ FP8

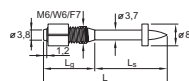

X-M8 ____ P8

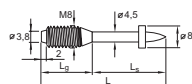

M10-24-32 P10

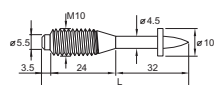

W10 ____ P10

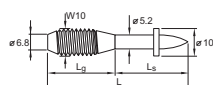

General information

Material specifications

Carbon steel shank: HRC 53.5
Zinc coating: 5–20 µm

Recommended fastening tools

DX 460, DX 5, DX 351, DX 36, DX 2, DX E72,
DX 76, DX 76 PTR, DX 600 N

See **X-M6, X-W6, X-M8, M10, W10 fastener program** in the next pages and **Tools and equipment chapter** for more details.

Approvals

ICC (USA): **X-W6, W10**

UL, FM: **W10**

Note:

Technical data presented in these approvals and design guidelines reflect specific local conditions and may differ from those published in this handbook.

Applications

Examples

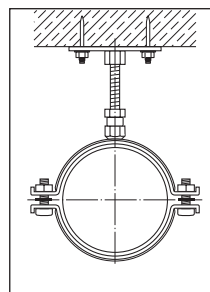

Plates for pipe rings

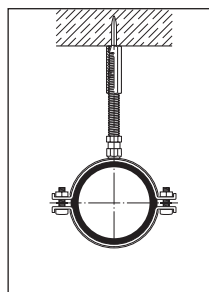

Hangings with threaded couplers

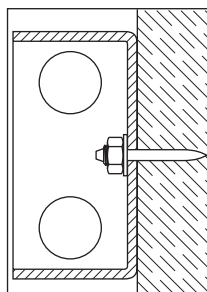

Electrical boxes

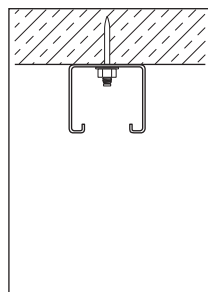

Miscellaneous attachments

Load data
Recommended loads

Fastener designation	Shank diameter d_s [mm]	M_{rec} [Nm]
X-M6/W6	3.7	5.0
X-M8, M10	4.5	9.0
W10	5.2	14.0

X-M6/W6, X-M8, M10, W10

$$N_{rec} = V_{rec} = 0.4 \text{ kN for } h_{ET} \geq 27 \text{ mm}$$

$$N_{rec} = V_{rec} = 0.3 \text{ kN for } h_{ET} \geq 22 \text{ mm}$$

$$N_{rec} = V_{rec} = 0.2 \text{ kN for } h_{ET} \geq 18 \text{ mm}$$

Arrangements to prevent moment on shank:

Coupler tight against concrete

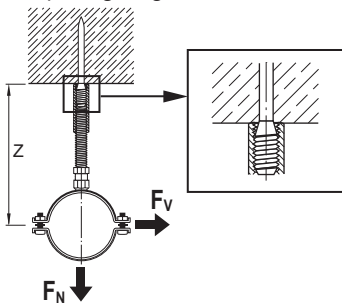

Non-symmetric arrangement:

- Moment on fastened part
- Prying effect must be considered in determining loads acting on fastener

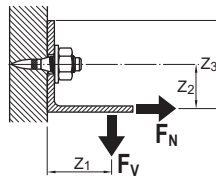
Conditions

- Minimum 5 fastenings per fastened unit (normal weight concrete)
- All visible failures must be replaced.
- With lightweight concrete base material and greater loading may be possible, please contact Hilti.
- Predominantly static loading.
- Observance of all application limitations and recommendations.
- The recommended loads in the table refer to the resistance of the individual fastening and may not be the same as the loads F_N and F_V acting on the fastened part.

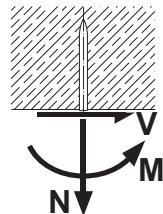

Note: If relevant, prying forces need to be considered in design, see example. Moment acting on fastener shank only in case of a gap between base and fastened material.

Application requirements

Thickness of base material

Concrete

$h_{\min} = 80 \text{ mm}$ ($d_{\text{nom}} = 3.7 \text{ mm}$)

$h_{\min} = 100 \text{ mm}$ ($d_{\text{nom}} \geq 4.5 \text{ mm}$)

Thickness of fastened material

M6: $t_l \leq L_g - t_{\text{washer}} - t_{\text{nut}} \equiv \text{up to } 15 \text{ mm}$

W6: $t_l \leq L_g - t_{\text{washer}} - t_{\text{nut}} \equiv \text{up to } 33 \text{ mm}$

M8: $t_l \leq L_g - t_{\text{washer}} - t_{\text{nut}} \equiv \text{up to } 15 \text{ mm}$

M10: $t_l \leq L_g - t_{\text{washer}} - t_{\text{nut}} \equiv \text{up to } 19 \text{ mm}$

W10: $t_l \leq L_g - t_{\text{washer}} - t_{\text{nut}} \equiv \text{up to } 25 \text{ mm}$

Spacing and edge distances (mm)

Pairs

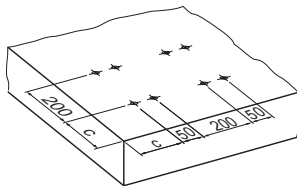

Reinforced * Non-reinforced

c 100 150

Row along edge

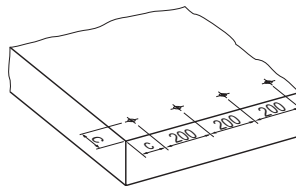

Reinforced * Non-reinforced

c 80 150

General (e.g. group of fasteners)

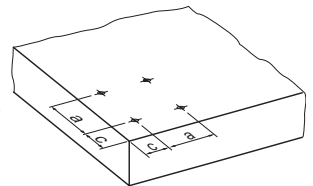

Reinforced * Non-reinforced

c 80 150

a 80 100

* Minimum $\varnothing 6$ reinforcing steel continuous along all edges and around all corners. Edge bars must be enclosed by stirrups.

Corrosion information

The intended use only comprises fastenings which are not directly exposed to external weather conditions or moist atmospheres. For further detailed information on corrosion see relevant chapter in **Direct Fastening Principles and Technique** section.

Fastener selection and system recommendation

Fastener selection

Required thread length

$L_g \geq t_l + t_{\text{washer}} + t_{\text{nut}}$ [mm]

Fastener program
Fasteners

Group ¹⁾	Designation	Item no.	Standard		Tool Designation
			threading ²⁾ L _g [mm]	shank lengths ²⁾ L _s [mm]	
M6	X-M6-20-27FP8	306079	20	27	DX 460, DX 5, DX 351, DX 36, DX 2, DX E72
W6	X-W6-20-22FP8	306073	20	22	DX 460, DX 5, DX 351, DX 36, DX 2, DX E72
	X-W6-20-27FP8	306074	20	27	DX 460, DX 5, DX 351, DX 36, DX 2, DX E72
	X-W6-38-27FP8	306075	38	27	DX 460, DX 5, DX 36, DX 2, DX E72
M8	X-M8-15-27P8	306092	15	27	DX 460, DX 5, DX 36, DX 2, DX E72
	X-M8-15-42P8	306094	15	42	DX 460, DX 5, DX 36, DX 2, DX E72
	X-M8-20-32P8	306096	20	32	DX 460, DX 5, DX 36, DX 2, DX E72
M10	M10-24-32P10	26413	24	32	DX 76, DX 76 PTR
W10	W10-30-27P10	26472	30	27	DX 600 N
	W10-30-32P10	26473	30	32	DX 600 N
	W10-30-42P10	26476	30	42	DX 600 N

¹⁾ Type threading: M = metric; W6, W10 = Whitworth 1/4"; 3/8"

²⁾ Standard threading and shank lengths. Other lengths and combinations available on special order.

Cartridge selection

Cartridge recommendation:

M6, W6, M8: 6.8/11M yellow or red cartridge

M10: 6.8/18M blue or red

W10: 6.8/18 yellow, red or black

Tool energy adjustment by setting tests on site.

Fastening quality assurance
Fastening inspection
X-M6 / W6

Penetration depth

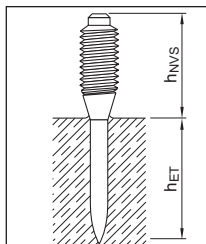

$$h_{NVS} = L_g \pm 2$$

Tightening torque

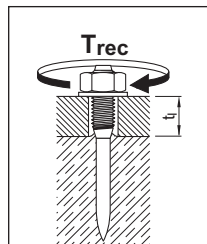

$$T_{rec} \leq 4 \text{ Nm}$$

X-M8, M10, W10

Penetration depth

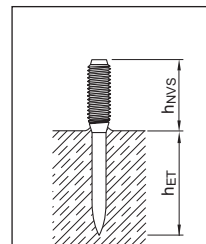

$$h_{NVS} = L_g \pm 2$$

Tightening torque

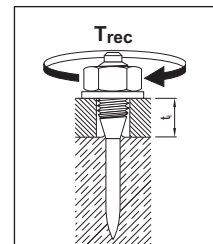

$$T_{rec} \leq 6 \text{ Nm}$$

X-EM6H, X-EW6H, X-EF7H, X-EM8H, X-EM10H, X-EW10H

Threaded stud for fastening to steel

Product data

Dimensions

X-EM6H/EW6H-__-9 FP8

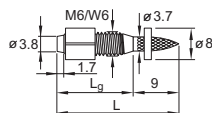

X-EF7H-7-9 FP8

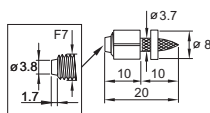

X-EM8H-__-12 P8

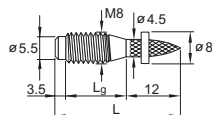

X-EM8H-15-12 FP10

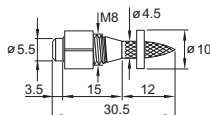

X-EM10H-24-12 P10

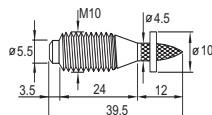

X-EW10H-30-14 P10

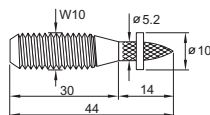

For dimension details see chapter fastener selection

General information

Material specifications

Carbon steel shank: HRC 56.5

Zinc coating: ¹⁾ 5–13 µm

¹⁾ Zinc coating (electroplating for corrosion protection during construction and service in protected environment)

Recommended fastening tools

DX 460, DX 5, DX 76, DX 76 PTR, DX 600 N

See **X-EM/ X-EW fastener program** in the next pages and **Tools and equipment chapter** for more details.

Approvals

ICC-ES ESR-2347 **X-EW6H, X-EW10H, (USA):**

FM 3026695: **X-EW6H, X-EW10H**

UL: EX2258: **X-EW6H, X-EW10H**

ABS, LR: all types



Applications

Examples

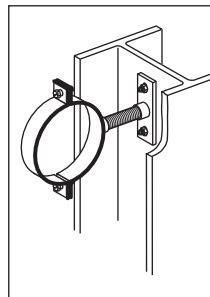

Base plates for pipe rings

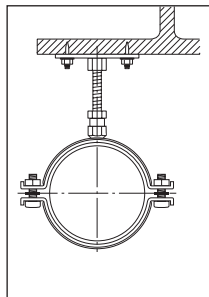

Hanging with threaded couplers

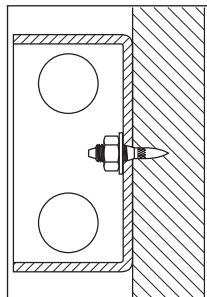

Electrical boxes

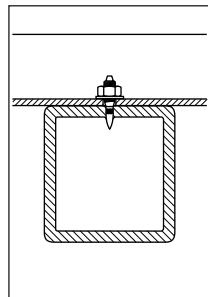

Miscellaneous attachments

Load data
Recommended loads

Fastener designation	Shank $d_s \times L_s$ [mm]	N_{rec} [kN]	V_{rec} [kN]	M_{rec} [Nm]
X-EM6H, X-EW6H, X-EF7H	3.7 x 8.5	1.6	1.6	5.0
X-EM8H, X-EM10H	4.5 x 12.0	2.4	2.4	9.0
X-EW10H-30-14	5.2 x 15.0	3.0	3.0	14.0

Conditions

- Redundancy (multiple fastening) must be provided.
- Global factor of safety for static pull-out > 3 (based on 5% fractile value).
- Predominantly static loading.
- Strength of fastened material must be considered.
- Observance of all application limitations and recommendations.
- The recommended loads in the table refer to the resistance of the individual fastening and may not be the same as the loads F_N and F_V acting on the fastened part.

Note: If relevant, prying forces need to be considered in design, see example. Moment acting on fastener shank only in case of a gap between base and fastened material.

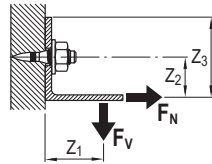
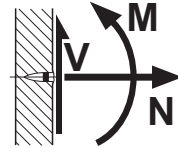

Arrangement to prevent moment on shank:
Coupler tight against steel

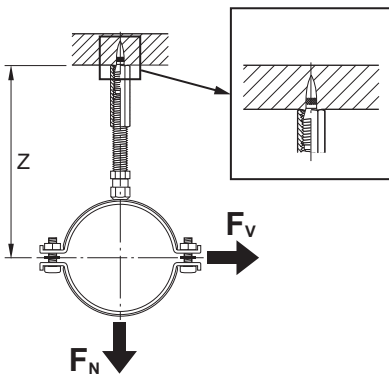

Application requirements

Thickness of base material

Minimum steel thickness:

	t_{II}
X-EM6H/EW6H, X-EF7H	≥ 4 mm
X-EM8H/EW8H, X-EM10H/X-EW10H	≥ 6 mm

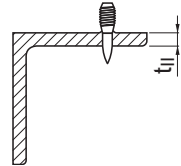

Thickness of fastened material

$$t_1 \leq L_g - t_{\text{washer}} - t_{\text{nut}} \approx 1.5\text{--}33.0 \text{ mm}$$

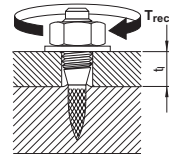

Spacing and edge distances

Edge distance and spacing: $c = s \geq 15$ mm

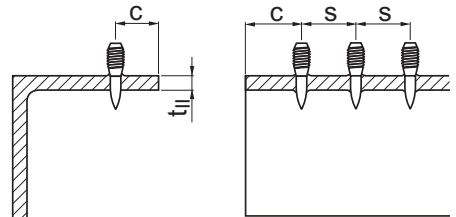

Corrosion information

The intended use only comprises fastenings which are not directly exposed to external weather conditions or moist atmospheres. For further detailed information on corrosion see relevant chapter in **Direct Fastening Principles and Technique** section.

Application limits

X-EM6H, X-EW6H, X-EF7H

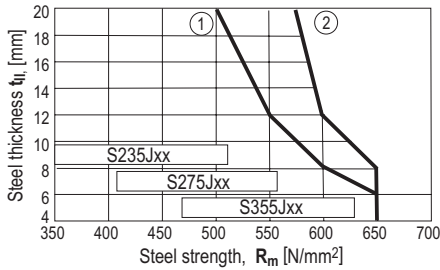

DX 460 / DX 5 tool:

- ① X-EF7H-__-9
- ② X-EM6H-__-9,
X-EW6H-__-9

X-EM8H

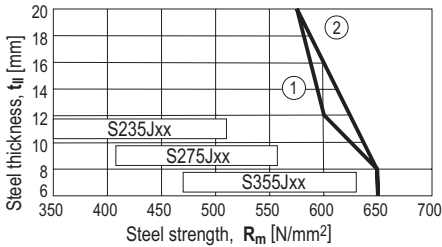

DX 460 / DX 5 tool:

- ① X-EM8H-__-12

**DX 76 / DX 76 PTR tool
with X-76-F10-PTR fastener guide:**

- ② X-EM8H-15-12

X-EM10H / X-EW10H

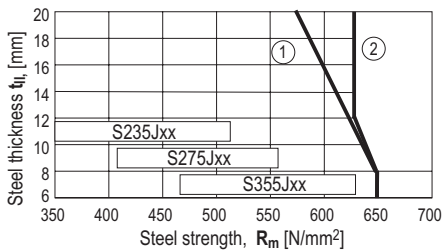

DX 76 / DX 76 PTR tool:

- ① X-EM10H-24-12

DX 600 N tool:

- ② X-EW10H-30-14 P10

Fastener selection and system recommendation

Fastener program

Base material thickness $t_{l,min}$ [mm]	Fastened thickness $t_{l,max}$ [mm]	Fastener Designation ¹⁾	Item no.	Threading length L_g [mm]	Shank lengths L_s [mm]	DX tools
4.0	1.5	X-EM6H-8-9 FP8	271965	8	8.5	DX 460, DX 5
	4.5	X-EM6H-11-9 FP8	271963	11	8.5	DX 460, DX 5
	13.5	X-EM6H-20-9 FP8	271961	20	8.5	DX 460, DX 5
	4.5	X-EW6H-11-9 FP8	271973	11	8.5	DX 460, DX 5
	13.5	X-EW6H-20-9 FP8	271971	20	8.5	DX 460, DX 5
	21.5	X-EW6H-28-9 FP8	271969	28	8.5	DX 460, DX 5
	31.5	X-EW6H-38-9 FP8	271967	38	8.5	DX 460, DX 5
	0.5	X-EF7H-7-9 FS8	271975	7	10	DX 460, DX 5
6.0	2.0	X-EM8H-11-12 P8	271983	11	12	DX 460, DX 5
	6.0	X-EM8H-15-12 P8	271981	15	12	DX 460, DX 5
	6.0	X-EM8H-15-12 FP10	271982	15	12	DX 76 PTR, DX 460, DX 5
	14.0	X-EM10H-24-12 P10	271984	24	12	DX 76 PTR, DX 460, DX 5
	20.0	X-EW10H-30-14 P10	271985	30	14	DX 600 N

¹⁾ Type of threading: **M** = metric; **W6**, **W10** = Whitworth $1/4''$; $3/8''$; **F7** = French 7 mm

Cartridge recommendation

Tool energy adjustment by installation tests on site

Fastener	Tool	Base material	Base material thickness (mm)	Cartridge selection
X-EM6H, X-EW6H	DX 460, DX 5	S235	4–10	6.8/11M green
			10–20	6.8/11M yellow
		S275	4– 6	6.8/11M green
			6–20	6.8/11M yellow
X-EF7H	DX 460, DX 5	S235	4– 8	6.8/11M green
			8–20	6.8/11M yellow
		S275	4– 6	6.8/11M green
			6–20	6.8/11M yellow
S355	4–20	6.8/11M yellow		
	X-EM8H	DX 460, DX 5	S235, S275	6– 8
S355			8–20	6.8/11M black
			6–20	6.8/11M black

Fastener	Tool	Base material	Base material thickness (mm)	Cartridge selection
X-EM8H	DX 76 PTR	S235	6- 8	6.8/18M blue
			8-20	6.8/18M red
		S275	6- 7	6.8/18M blue
			7-12 12-20	6.8/18M red 6.8/18M black
S355	6-10	6.8/18M red		
	10-20	6.8/18M black		
X-EM10H	DX 76 PTR	S235	6 -20	6.8/18M yellow
			S275	6- 7
		7- 8		6.8/18M blue
		8-20		6.8/18M red
S355	6- 8	6.8/18M red		
	8-20	6.8/18M black		
X-EW10H	DX 600 N	S235	6- 8	6.8/18 blue
			8-15	6.8/18 red
			15-20	6.8/18 black
		S275	6- 8	6.8/18 blue
			8-12	6.8/18 red
			12-20	6.8/18 black
S355	6- 7	6.8/18 red		
	7-20	6.8/18 black		

Fastening inspection

X-EM6H, X-EW6H, X-EF7H

X-EM8H, X-EM10H, X-EW10H

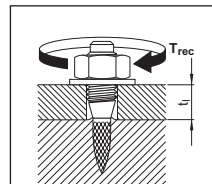
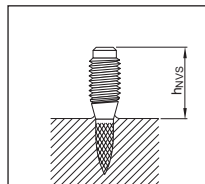
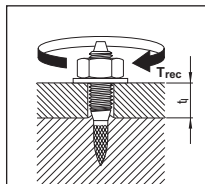
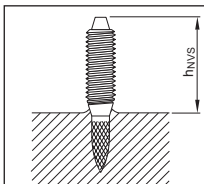
Nail standoff
Tightening torque
Nail standoff
Tightening torque

Fastener	h_{NVS} [mm]	T_{rec} [Nm]
X-EM6H-8-9	8.0-11.0	≤ 4
X-EM6H- / X-EW6H-11-9	9.5-12.5	≤ 4
X-EM6H- / X-EW6H-20-9	18.5-21.5	≤ 4
X-EW6H-28-9	26.5-29.5	≤ 4
X-EW6H-38-9	36.5-39.5	≤ 4
X-EF7H-7-9	9.0-12.0	≤ 4

Fastener	h_{NVS} [mm]	T_{rec} [Nm]
X-EM8H-11-12	11.5-15.5	≤10.5
X-EM8H-15-12	15.5-19.5	≤10.5
X-EM10H-24-12	26.5-29.5	≤10.5
X-EW10H-30-14	28.0-31.0	≤15.0

X-BT Stainless steel threaded stud

Product data

Dimensions

X-BT W10-24-6 SN12-R
X-BT M10-24-6 SN12-R

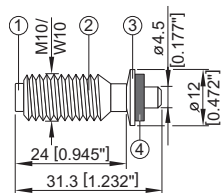

X-BT M8-15-6 SN12-R

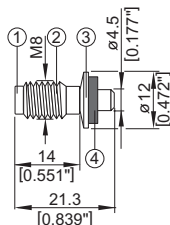

X-BT W6-24-6 SN12-R
X-BT M6-24-6 SN12-R

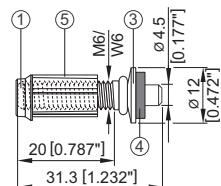

General information

Material specifications

① Shank:

CR 500 (CrNiMo alloy) equivalent to A4 /
S31803 (1.4462) AISI grade 316 material
N 08926 (1.4529) ¹ Available on request

② Threaded sleeve:

S31609
(X5CrNiMo 17-12-2+2H, 1.4401)

③ SN12-R washers:

S 31635
(X2CrNiMo 17-12-2, 1.4404)

④ Sealing washers:

Chloroprene rubber CR
3.1107, black* Resistant to UV, salt water, water, ozone, oils, etc.

¹⁾ For High Corrosion Resistance HCR material inquire at Hilti

Designation according to Unified Numbering System (UNS)

Recommended fastening tools

BX 3-BT / BTG
DX 351-BT / BTG

See **X-BT fastener program** in the next pages and **Tools and equipment** chapter for more details.

Approvals

ICC ESR-2347 (USA), ABS, LR, DNV-GL, BV 23498/B0, GL 12272-10HH, Russian Maritime Register



Applications

Examples

Threaded stud applications especially for:

- High strength steel
- Coated steel structures
- Through penetration of base steel is not allowed

Grating with X-FCM-R

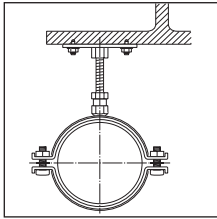

Base plates

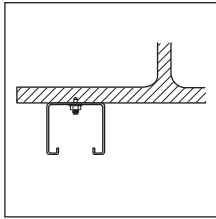

Installation rails

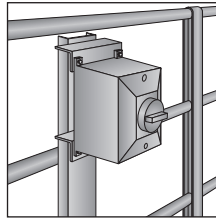

Junction box, etc.

Load data

Recommended loads – Steel

Steel grade: Europe, USA	S235, A36	S355, Grade 50 and stronger steel
Tension, N_{rec} [kN/lb]	1.8 / 405	2.3 / 517
Shear, V_{rec} [kN/lb]	2.6 / 584	3.4 / 764
Moment, M_{rec} [Nm/lbft]	8.2 / 6	8.2 / 6
Torque, T_{rec} [Nm/lbft]	8 / 5.9	8 / 5.9

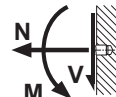

Example:

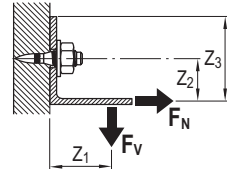

Recommended loads – cast iron *

Tension, N_{rec} [kN/lb]	0.5 / 115
Shear, V_{rec} [kN/lb]	0.75 / 170
Moment, M_{rec} [Nm/lbft]	8.2 / 6

Conditions for recommended loads:

- Global factor of safety for static pull-out > 3 (based on 5% fractile value)
- Minimum edge distance = 6 mm [$1/4"$].
- Effect of base metal vibration and stress considered.
- Redundancy (multiple fastening) must be provided.
- The recommended loads in the table refer to the resistance of the individual fastening and may not be the same as the loads F_N and F_V acting on the fastened part.

Note: If relevant, prying forces need to be considered in design, see example. Moment acting on fastener shank only in case of a gap between base and fastened material.

*Requirements of spheroidal graphite cast iron base material

Subject	Requirements
Cast iron	Spheroidal graphite cast iron according to EN 1563
Strength class	EN-GJS-400 to EN-GJS-600 according to EN 1563
Chemical analysis and amount of carbon	3.3–4.0 mass percentage
Microstructure	Form IV to VI (spherical) according to EN ISO 945-1:2010 Minimum size 7 according to Figure 4 of EN ISO 945-1:2010
Material thickness	$t_{II} \geq 20$ mm

Design resistance – steel

Steel grade:

Europe	S235	S355
Tension N_{Rd} [kN]	2.9	3.7
Shear V_{Rd} [kN]	4.2	5.4
Moment M_{Rd} [Nm]	18.4	18.4

Design resistance – cast iron *

Tension N_{RD} [kN]	0.8
Shear V_{RD} [kN]	1.2
Moment M_{RD} [Nm]	13.1

Recommended interaction formula for combined loading

Combined loading situation

Interaction formula

$$\mathbf{V-N} \text{ (shear and tension)} \quad \frac{V}{V_{rec}} + \frac{N}{N_{rec}} \leq 1.2 \text{ with } \frac{V}{V_{rec}} \leq 1.0 \text{ and } \frac{N}{N_{rec}} \leq 1.0$$

$$\mathbf{V-M} \text{ (shear and bending)} \quad \frac{V}{V_{rec}} + \frac{M}{M_{rec}} \leq 1.2 \text{ with } \frac{V}{V_{rec}} \leq 1.0 \text{ and } \frac{M}{M_{rec}} \leq 1.0$$

$$\mathbf{N-M} \text{ (tension and bending)} \quad \frac{N}{N_{rec}} + \frac{M}{M_{rec}} \leq 1.0$$

$$\mathbf{V-N-M} \text{ (shear, tension and bending)} \quad \frac{V}{V_{rec}} + \frac{N}{N_{rec}} + \frac{M}{M_{rec}} \leq 1.0$$

Cyclic loading:

- Anchorage of **X-BT-R** threaded stud in steel base material is not affected by cyclic loading.
- Fatigue strength is governed by fracture of the shank. Inquire at Hilti for test data if high cycle loading has to be considered in the design.

Application requirements

Thickness of base material

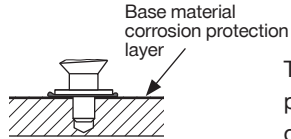
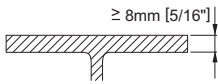

Thickness of base material corrosion protection layer $\leq 0.4\text{mm}$. For thicker coatings, please contact Hilti.

Thickness of fastened material

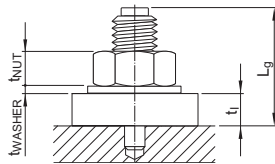

X-BT M8:	$2.0 \leq t_1 \leq 7.0 \text{ mm}$
X-BT M10 / X-BT W10:	$2.0 \leq t_1 \leq 15.0 \text{ mm}$
X-BT M6 / X-BT W6:	$1.0 \leq t_1 \leq 14.0 \text{ mm}$

Note:

For X-BT with SN 12R sealing washer $t_1 \geq 2.0 \text{ mm}$

For X-BT M6 / W6 with SN 12R sealing washer $t_1 \geq 1.0 \text{ mm}$

Spacing and edge distances

Edge distance: $\geq 6 \text{ mm}$

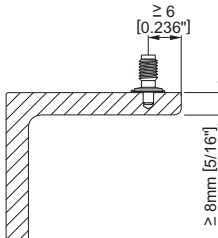

Spacing: $\geq 15 \text{ mm}$

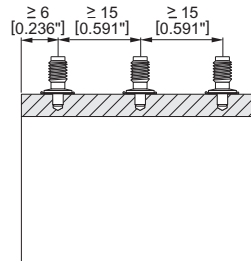

Corrosion information

The corrosion resistance of Hilti CR500 and S31803 (1.4462) stainless steel material is equivalent to AISI 316 (A4) steel grade.

Studs made of N 08926 (HCR) material with higher corrosion resistance, e.g. for use in road tunnels or swimming pools, are available on special order.

Application limit

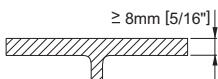

- $t_{II} \geq 8 \text{ mm}$ [$5/16$ "] \rightarrow No through penetration
- No limits with regards to steel strength

Fastener selection and system recommendation

Fastener program

Designation	Item no.	Tool Designation
X-BT M8-15-6 SN12-R	377074	BX 3-BTG, DX 351-BTG
X-BT M10-24-6 SN12-R	377078	BX 3-BT, DX 351-BT
X-BT W10-24-6 SN12-R	377076	BX 3-BT, DX 351-BT
X-BT W10 without washer	377075	BX 3-BT, DX 351-BT
X-BT M6-24-6 SN12-R	432266	BX 3-BT, DX 351-BT
X-BT W6-24-6 SN12-R	432267	BX 3-BT, DX 351-BT

Note: For High Corrosion Resistance HCR material inquire at Hilti

Cartridge selection and tool energy setting

6.8/11 M high precision brown cartridge

Fine adjustment by installation tests on site

Fastening quality assurance

Fastening inspection

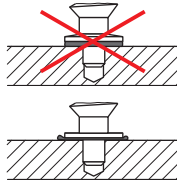
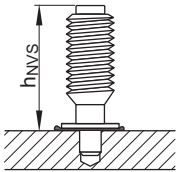

X-BT M8
 $h_{NVS} = 15.7-16.8 \text{ mm}$

**X-BT M10 / X-BT W10 and
 X-BT M6 / X-BT W6**
 $h_{NVS} = 25.7-26.8 \text{ mm}$

Installation

X-BT with washer

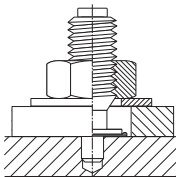

Fastened material hole ϕ
 $\geq 13 \text{ mm}$

X-BT M6 / X-BT W6

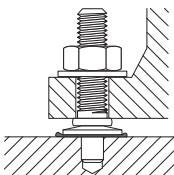

Fastened material with
 pre-drilled hole diameter
 $< 7 \text{ mm}$

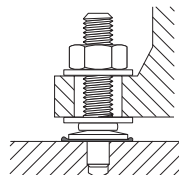

Fastened material with
 pre-drilled hole diameter
 $\geq 7 \text{ mm}$

Pre-drill with **TX-BT 4/7** step shank drill bit

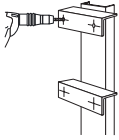

Pre-drill until the shoulder grinds a shiny ring (to ensure proper drilling depth)

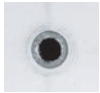

Before fastener installation:

the drilled hole must be clear of liquids and debris. The area around the drilled hole must be free from liquids and debris.

Tighten using a screwdriver with torque clutch

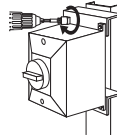

Tightening torque:
T_{rec} ≤ 8 Nm (5.9 ft-lb)!

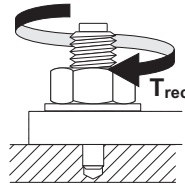

Hilti Torque tool X-BT 1/4"

Hilti screwdriver:	Torque setting:
SF 121-A	11
SF 150-A	9
SF 180-A	8
SF 144-A	9
SF 22A	9
SFC 22-A	5
SBT 4-A22	5

These are abbreviated instructions which may vary by application.
ALWAYS review/follow the instructions accompanying the product.

X-BT New Generation stainless steel threaded stud

Product data

Dimensions

X-BT-MR M10/15 SN 8
X-BT-MR W10/15 SN 8

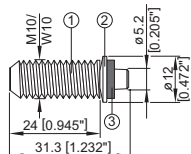

X-BT-MR M8/14 SN 8

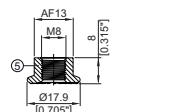
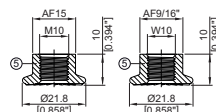
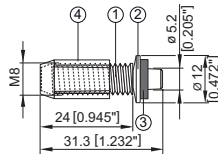

X-BT-MR M6/10 SN 8
X-BT-MR W6/10 SN 8

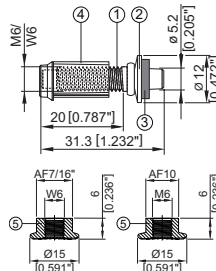

X-BT-GR M8/7 SN 8

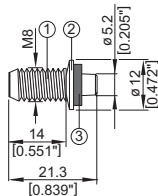

Features and benefits

The X-BT system is an approved Fastening on Steel system for grating and multi-purpose fastening applications. Benefits include no-rework to backside of base material, not having application limits and capability to work in C5 corrosive environment. The new generation X-BT system has increased load performance compared with the previous X-BT.

General information

Material specifications

- ① Shank: S31803 (1.4462) equivalent to A4 / AISI grade 316 material
- ② SN washers: S 31635 (X2CrNiMo 17-12-2, 1.4404)
- ③ Sealing washers: Elastomer, black, resistant to UV, salt water, water, ozone, oils, etc.
- ④ Guiding sleeve: Plastic
- ⑤ Flange nuts: A4 / AISI grade 316 material
Designation according to Unified Numbering System (UNS)

Recommended fastening tools

BX 3-BT / BTG
DX 351-BT / BTG

See **X-BT fastener program** in the next pages and **Tools and equipment** chapter for more details.

Fasteners approvals

ABS: 18-HS1755518, DNV-GL TAS00001SV, BV 54554, LR 19/0003, ICC-ES ESR-2347 (USA)

Applications

Examples

Threaded stud applications especially for:

- High strength steel
- Coated steel structures
- Through penetration of base steel is not allowed

* Grating with X-BT-GR and X-FCM-R (HL)

* Load data, application requirements, corrosion information, fastener selection, system recommendation, material specification and coating refer to section X-FCM-R, X-FCM-R HL or X-FCS-R Grating Fastening System in the Direct Fastening Technology Manual

Multi purpose fastening with X-BT-MR

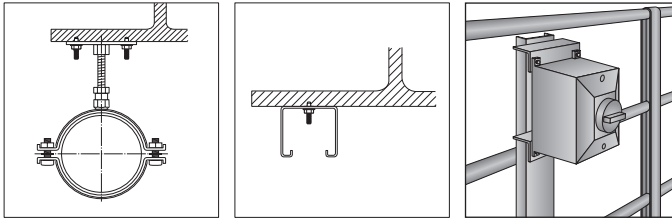

Junction box, etc.

Performance data – Construction steel

Recommended loads – steel base material

Steel grade: Europe, USA	S235, S275 A36	S355 to S960 ≥ Grade 50
Tension, N_{rec} [kN/lb]	3.6 / 810	4.6 / 1030
Shear –		
form lock V_{rec} [kN/lb]	4.3 / 970	5.3 / 1190
friction lock V_{rec} [kN/lb]	0.20 / 45	0.20 / 45
Moment, M_{rec} [Nm/lbft]	20.0 / 14.8	20.0 / 14.8
Torque, T_{rec} [Nm/lbft]	20.0 / 14.8	20.0 / 14.8

Example:

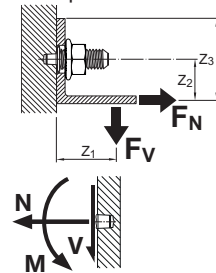

Conditions for recommended loads:

- Application of working load design concept (e.g. ASD)
- For unalloyed construction, off-shore and Shipbuilding steel: e.g. European grades S235, S275, S355 according to EN 10025-2, S355M, S420M, S460M according to EN 10025-4 or EN 10225, S690Q and S960Q according to EN10025-6, US steel grade A36 and Grade 50.
- Minimum base material thickness $t_{II} = 8$ mm.
- Applicable for steel base materials up to a coating thickness of 500 μ m.
- Edge distance $c \geq 10$ mm [3/8"].
- In case of edge distance 6 mm $\leq c < 10$ mm, N_{rec} , V_{rec} and M_{rec} need to be reduced with the reduction factor $\alpha_c = 0.65$.
- For group fastenings with up to 4 fasteners per group and shear force introduction via the sealing washer, the resistance of all fasteners can be added up, provided the hole in the fastened material is equal or less than 14 mm (e.g. $V_{rec,group} = 17.2$ kN for a group with 4 fasteners fixed to S235 base material). For more details see "New Generation Hilti X-BT-GR, X-BT-MR and X-BT-ER Threaded Fastener Specification".
- Redundancy (multiple fastening) must be provided.

Remarks:

- The recommended loads in the table refer to the resistance of the single fastener and need to be determined by static analysis from the loads F_N and F_V acting on the fastened part. Typical example is the need of consideration of prying forces, see example.
- Moments acting on the shank only need to be considered in case of a gap between the base and the fastened material.
- Global factor of safety for tension and shear load = 2.8 related to the characteristic resistance N_{Rk} and V_{Rk}
- Global factor of safety for bending moment = 1.75 related to the characteristic bending moment $M_{R,k}$ of the shank.
- Effects of base metal vibration and stresses are considered.
- For difference of form and friction lock for shear resistance, refer to explanations at the end of this data sheet.

Characteristic resistance – steel base material

Steel grade: Europe, USA	S235, S275, A36	S355 to S960, ≥ Grade 50
Tension N_{Rk} [kN/lb]	10.0 / 2240	13.0 / 2920
Shear –		
form lock V_{Rk} [kN/lb]	12.0 / 2700	15.0 / 3360
friction lock V_{Rk} [kN/lb]	0.56 / 125	0.55 / 125
Moment M_{Rk} [Nm/lbft]	35.0 / 25.5	35.0 / 25.5

Design resistance – steel base material

Steel grade: Europe, USA	S235, S275, A36	S355 to S960, ≥ Grade 50
Tension N_{Rd} [kN/lb]	5.0 / 1120	6.5 / 1460
Shear –		
form lock V_{Rd} [kN/lb]	6.0 / 1350	7.5 / 1680
friction lock V_{Rd} [kN/lb]	0.28 / 62	0.28 / 62
Moment M_{Rd} [Nm/lbft]	28.0 / 20.5	28.0 / 20.5

Performance data – Cast iron
Recommended loads – cast iron *

Tension, N_{rec} [kN/lb]	1.0 / 230
Shear –	
form lock V_{rec} [kN/lb]	1.5 / 340
friction lock V_{rec} [kN/lb]	0.20 / 45
Moment, M_{rec} [Nm/lbft]	16.0 / 11.5

Design resistance – cast iron *

Tension N_{Rd} [kN/lb]	1.6 / 360
Shear	
form lock V_{Rd} [kN/lb]	2.4 / 540
friction lock V_{Rd} [kN/lb]	0.28 / 62
Moment M_{Rd} [Nm/lbft]	26.0 / 19.0

***Requirements of spheroidal graphite cast iron base material**

Subject	Requirements
Cast iron	Spheroidal graphite cast iron according to EN 1563
Strength class	EN-GJS-400 to EN-GJS-600 according to EN 1563
Chemical analysis and amount of carbon	3.3 – 4.0 mass percentage
Microstructure	Form IV to VI (spherical) according to EN ISO 945-1:2010 Minimum size 7 according to Figure 4 of EN ISO 945-1:2010
Material thickness	t _{II} ≥ 20 mm

Recommended interaction formula for combined loading - steel and cast iron base material

Load combination	Interaction provision
V-N (shear and tension)	$\frac{V_{Sd}}{V_{Rd}} + \frac{N_{Sd}}{N_{Rd}} \leq 1.2$ with $\frac{V_{Sd}}{V_{Rd}} \leq 1.0$ and $\frac{N_{Sd}}{N_{Rd}} \leq 1.0$
V-M (shear and bending)	$\frac{V_{Sd}}{V_{Rd}} + \frac{M_{Sd}}{M_{Rd}} \leq 1.2$ with $\frac{V_{Sd}}{V_{Rd}} \leq 1.0$ and $\frac{M_{Sd}}{M_{Rd}} \leq 1.0$
N-M (tension and bending)	$\frac{N_{Sd}}{N_{Rd}} + \frac{M_{Sd}}{M_{Rd}} \leq 1.0$
V-N-M (shear, tension and bending)	$\frac{V_{Sd}}{V_{Rd}} + \frac{N_{Sd}}{N_{Rd}} + \frac{M_{Sd}}{M_{Rd}} \leq 1.0$

Cyclic loading:

- Anchorage of X-BT threaded stud in steel base material is not affected by cyclic loading.
- Fatigue strength is governed by fracture of the shank. For more details see "New Generation Hilti X-BT-GR, X-BT-MR and X-BT-ER Threaded Fastener Specification".

Application requirements

Application limit and thickness of base material

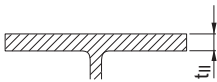

$t_{II} \geq 8 \text{ mm [5/16"]} \rightarrow$ No through-penetration.
No limits with regard to steel strength.

Thickness of fastened material

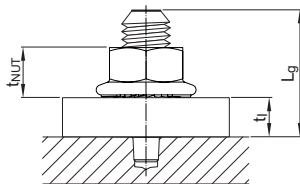

- X-BT-GR M8: $2.0 \leq t \leq 7.0 \text{ mm}$
- X-BT-MR M10/W10: $2.0 \leq t \leq 15.0 \text{ mm}$
- X-BT-MR M8: $2.0 \leq t \leq 14.0 \text{ mm}$
- X-BT-MR M6/W6: $2.0 \leq t \leq 10.0 \text{ mm}^*$

* if base material sits on the collar of the stud $t_{II, \min} = 1.0 \text{ mm}$

Spacing and edge distances

Edge distance:

- $c \geq 10 \text{ mm}$ (load reduction factor $\alpha_c = 1.00$)
- $6 \text{ mm} \leq c < 10 \text{ mm}$ (load reduction factor $\alpha_c = 0.65$)

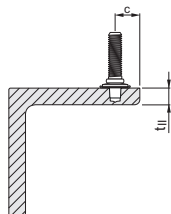

Spacing:

- $s \geq 15 \text{ mm}$

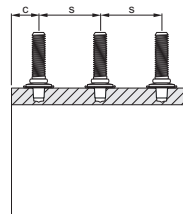

Corrosion information

The corrosion resistance of S31803 (1.4462) stainless steel material is equivalent to AISI 316 (A4) steel grade. For detailed information see “New Generation Hilti X-BT-GR, X-BT-MR and X-BT-ER Threaded Fastener Specification”.

Fastener selection and system recommendation

Fastener program

Designation	Item no.	Tool Designation
X-BT-GR M8/7 SN 8	2194344	BX 3-BTG, DX 351-BTG
X-BT-MR M6/10 SN 8	2252199	BX 3-BT, DX 351-BT
X-BT-MR M6/14 SN8	2194337	DX 351-BT
X-BT-MR W6/10 SN 8	2252470	BX 3-BT, DX 351-BT
X-BT-MR W6/14 SN 8	2194338	DX 351-BT
X-BT-MR M8/14 SN 8	2194339	BX 3-BT, DX 351-BT
X-BT-MR M10/15 SN 8	2194340	BX 3-BT, DX 351-BT
X-BT-MR W10/15 SN 8	2194341	BX 3-BT, DX 351-BT

Cartridge selection and tool energy setting

DX 351-BTG, DX 351-BT: 6.8/11 M high precision brown cartridge

Battery selection and fastener guide adjustment

BX 3-BT, BX 3-BTG: 22 V cordless tool battery platform

Battery recommendation: B 22/2.6, also allowed B 22/3.0, B 22/4.0, B 22/5.2

The recommended fastener guide position is “1” (if required, adjust the fastener guide position based on job site tests and IFU).

Fastening quality assurance

Fastening inspection

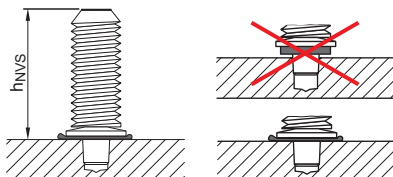

X-BT-GR M8

$h_{NVS} = 15.7-16.8 \text{ mm}$

X-BT-MR M6/W6/M8/M10/W10

$h_{NVS} = 25.7-26.8 \text{ mm}$

Installation

X-BT-MR M8

Fastened material:

- Hole diameter: 13 to 14 mm: Use of supplied flange nut ①
- Hole diameter: beyond 14 to 18 mm: Use of supplied flange nut with supplement washer (maximum thickness of fixed component to be reduced with thickness of washer) ②

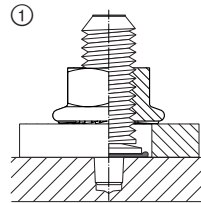

X-BT-MR M10/W10

Fastened material:

- Hole diameter: 13 to 18 mm: Use of supplied flange nut ①
- Hole diameter: beyond 18 to 22 mm: Use of supplied flange nut with supplement washer (maximum thickness of fixed component to be reduced with thickness of washer) ②

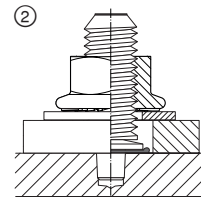

X-BT-MR M6/W6

Fastened material:

- Hole diameter: 6.5 – 6.7: Fastener sits on collar of stud, use of supplied flange nut ③
- Hole diameter: 6.7 to 11 mm: Use of supplied flange nut with supplement washer sitting on collar ④
- Hole diameter: > 12 mm, fixed part sits on base material, use of flange nut with supplemental washer to cover hole clearance (maximum thickness of fixed component to be reduced with thickness of washer) ②

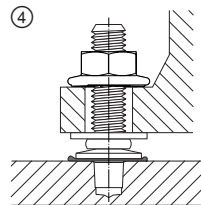
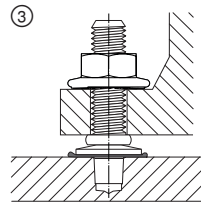

Remarks on group fastenings

For group fastenings with up to 4 fasteners per group and shear force introduction via the sealing washer, the resistance of all fasteners can be added up, provided the hole in the fastened material is equal or less than 14 mm. For detailed information see “New Generation Hilti X-BT-GR, X-BT-MR and X-BT-ER Threaded Fastener Specification”.

Pre-drill with **TX-BT 4.7/7** step shank drill bit

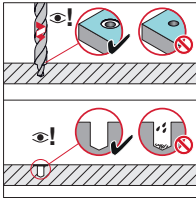
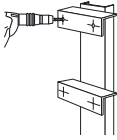

Pre-drill until shoulder grinds a shiny ring.
The drill hole and the area around drilled hole must be clean and free from liquids and debris.

Tighten using a screwdriver with torque clutch

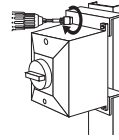

Tightening torque:
 $T_{rec} \leq 20 \text{ Nm}$ (14.8 ft-lb)!

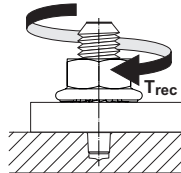

Hilti Torque tool X-BT 1/4"
– 20 Nm / 14.8 ft-lb
2212510



X-BT 1/4" 20 Nm / 14.8 lb-ft

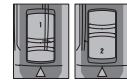

Gear



Clutch

Hilti cordless screwdriver setting recommendations

Hilti cordless screwdriver	X-BT-MR M6/W6		X-BT-MR M8		X-BT-MR M10/W10	
	Gear	Clutch	Gear	Clutch	Gear	Clutch
SF 14-A	3	15	3	12	3	13
SF 10W-A22	4	15	4	8	4	11
SF 8M-A22	4	15	4	12	4	11
SFC 14-A	2	15	2	13	2	11
SFC 22-A	2	15	2	14	2	11
SF 6-A22	-	-	1	1	1	1

These are abbreviated instructions which may vary by application.
ALWAYS review/follow the instructions accompanying the product.

Form and friction lock for shear connection
Shear load transfer via friction lock is relevant if non-slip connections are required in the service state:

- Fixing the position of channel sections with slotted holes and forces in direction of the slots
- Connections with hole clearance beyond 14 mm

Slotted holes or bigger hole clearance allow easier assembly and geometric adjustment of the fixed component. Consequently form lock mechanism by means of direct contact of the fixed component with the washer of the X-BT-MR cannot be easily ensured with little slip in those cases. The New Generation X-BT-MR fasteners allow the use higher torque of 20 Nm resulting in a friction shear connection capacity. That friction lock can be utilized to fix the position of the attached component as well as for shear load transfer if the demand is comparably small. In case of high shear demand, the form lock mechanism has to be activated and can further be optimized for group fastenings (for more details on group fastenings relying on form lock, see „New Generation Hilti X-BT-GR, X-BT-MR and X-BT-ER Threaded Fastener Specification“)

Examples of friction lock:

- MQ-41 channel with X-BT-MR M10/15 SN 8 and varying distances e_1 and e_2

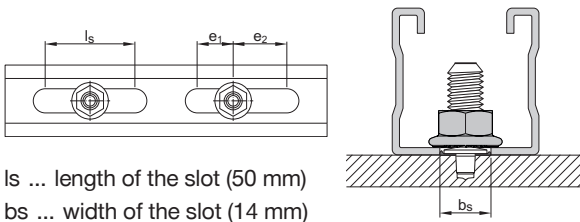

l_s ... length of the slot (50 mm)
 b_s ... width of the slot (14 mm)

- X-BT-MR connections with maximum hole diameter in fixed material

X-BT-MR M8/14 SN 8,

max. hole diameter = 18 mm

X-BT-MR M10/15 SN 8,

max. hole diameter = 22 mm

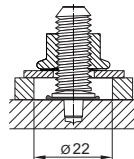
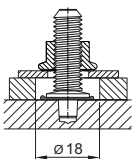
Conditions and remarks:

- The use of friction lock connection forces requires the application of an installation torque $T = 20$ Nm.
- Friction lock not suitable in case of base material vibrations.
- The friction lock values are suitable to fix the position of components and in case of lower shear load demand. Full shear load capacity are developed by means of form lock via contact of the fixed component with the sealing washer of the X-BT-MR.

X-BT-MR-N Stainless steel threaded stud for narrow through hole

Product data

Dimensions

X-BT-MR-N M8/14 N 4

X-BT-MR-N M8/4 N 4

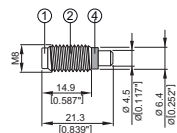
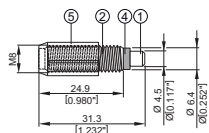

Note on drill-bit:

X-BT-MR-N requires the use of the specific drill bit TX-BT 4/5.5. The drill bit TX-BT 4/7, which is used for X-BT, X-BT-MF and X-BT-ER fasteners must not be used for X-BT-MR-N studs.

General information

Material specifications

- ① Shank:
 - CR 500 (CrNiMo alloy) equivalent to A4 / S31803 (1.4462)
 - AISI grade 316 material N 08926 (1.4529) ¹
 - Available on request
- ② Threaded sleeve: S31609
 - (X5CrNiMo 17-12-2+2H, 1.4401)
- ④ Sealing washers: Chloroprene rubber CR 3.1107, black*
- ⑤ Guide sleeve: Plastic

* Resistant to UV, salt water, water, ozone, oils, etc.

¹) For High Corrosion Resistance HCR material inquire at Hilti

Designation according to Unified Numbering System (UNS)

Recommended fastening tools

DX 351-BT / BTG

See **X-BT fastener program** in the next pages and **Tools and equipment** chapter for more details.

Approvals

ABS, LR, DNV-GL, BV



Applications

Examples

Threaded stud applications especially for:

- High strength steel
- Coated steel structures
- Through penetration of base steel is not allowed

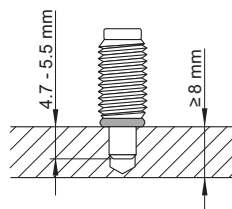

Load data

Recommended loads – steel

Steel grade: Europe, USA	S235, A36	S355, Grade 50 and stronger steel
Tension, N_{rec} [kN/lb]	1.8 / 405	2.3 / 517
Shear, V_{rec} [kN/lb]	2.6 / 584	3.4 / 764
Moment, M_{rec} [Nm/lbft]	8.2 / 6	8.2 / 6
Torque, T_{rec} [Nm/lbft]	8 / 5.9	8 / 5.9

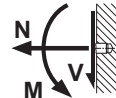

Example:

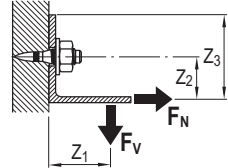

Recommended loads – cast iron *

Tension, N_{rec} [kN/lb]	0.5 / 115
Shear, V_{rec} [kN/lb]	0.75 / 170
Moment, M_{rec} [Nm/lbft]	8.2 / 6

Conditions for recommended loads:

- Global factor of safety for static pull-out > 3 (based on 5% fractile value)
- Minimum edge distance = 6 mm [$1/4"$].
- Effect of base metal vibration and stress considered.
- Redundancy (multiple fastening) must be provided.
- The recommended loads in the table refer to the resistance of the individual fastening and may not be the same as the loads F_N and F_V acting on the fastened part.
Note: If relevant, prying forces need to be considered in design, see example. Moment acting on fastener shank only in case of a gap between base and fastened material.

*Requirements of spheroidal graphite cast iron base material

Subject	Requirements
Cast iron	Spheroidal graphite cast iron according to EN 1563
Strength class	EN-GJS-400 to EN-GJS-600 according to EN 1563
Chemical analysis and amount of carbon	3.3–4.0 mass percentage
Microstructure	Form IV to VI (spherical) according to EN ISO 945-1:2010 Minimum size 7 according to Figure 4 of EN ISO 945-1:2010
Material thickness	$t_{II} \geq 20$ mm

Design resistance – steel

Steel grade:		S235	S355
Europe			
Tension	N_{Rd} [kN]	2.9	3.7
Shear	V_{Rd} [kN]	4.2	5.4
Moment	M_{Rd} [Nm]	18.4	18.4

Design resistance – cast iron *

Tension	N_{Rd} [kN]	0.8
Shear	V_{Rd} [kN]	1.2
Moment	M_{Rd} [Nm]	13.1

Recommended interaction formula for combined loading - steel and cast iron base material

Combined loading situation	Interaction formula
----------------------------	---------------------

V–N (shear and tension) $\frac{V}{V_{rec}} + \frac{N}{N_{rec}} \leq 1.2$ with $\frac{V}{V_{rec}} \leq 1.0$ and $\frac{N}{N_{rec}} \leq 1.0$

V–M (shear and bending) $\frac{V}{V_{rec}} + \frac{M}{M_{rec}} \leq 1.2$ with $\frac{V}{V_{rec}} \leq 1.0$ and $\frac{M}{M_{rec}} \leq 1.0$

N–M (tension and bending) $\frac{N}{N_{rec}} + \frac{M}{M_{rec}} \leq 1.0$

V–N–M (shear, tension and bending) $\frac{V}{V_{rec}} + \frac{N}{N_{rec}} + \frac{M}{M_{rec}} \leq 1.0$

Cyclic loading:

- Anchorage of **X-BT-MR-N** threaded stud in steel base material is not affected by cyclic loading.
- Fatigue strength is governed by fracture of the shank. Inquire at Hilti for test data if high cycle loading has to be considered in the design.

Application requirements

Thickness of base material

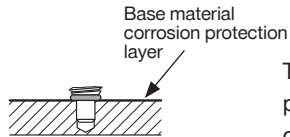
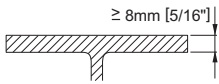

Thickness of base material corrosion protection layer $\leq 0.4\text{mm}$. For thicker coatings, please contact Hilti.

Thickness of fastened material

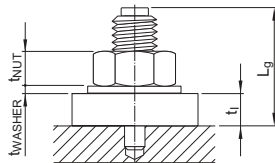

X-BT-MR-N M8/4 N 4: $t_1 \leq 4\text{ mm}$

X-BT-MR-N M8/14 N 4: $4\text{ mm} \leq t_1 \leq 14\text{ mm}$

For thickness less than 4 mm, reduction of shear loading is required, please contact Hilti.

Spacing and edge distances

Edge distance: $\geq 6\text{ mm}$

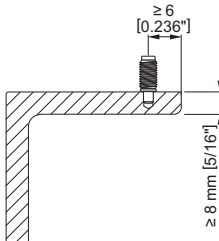

Spacing: $\geq 15\text{ mm}$

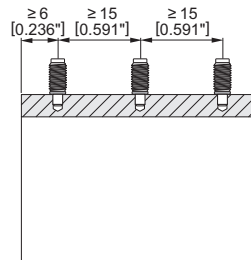

Corrosion information

The corrosion resistance of Hilti CR500 and S31803 stainless steel material is equivalent to AISI 316 (A4) steel grade.

Application limit

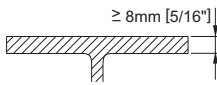

- $t_{II} \geq 8 \text{ mm } [5/16"] \rightarrow$ No through penetration
- No limits with regards to steel strength

Fastener selection and system recommendation

Fastener program

Designation	Item no.	Tool Designation
X-BT-MR-N M8/14 N 4	2112004	DX 351 BT
X-BT-MR-N M8/4 N 4	2112003	DX 351 BTG

Cartridge selection and tool energy setting

6.8/11 M high precision brown cartridge

Fine adjustment by installation tests on site

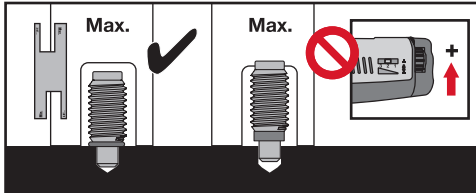
Fastening quality assurance
Fastening inspection

X-BT-MR-N M8/4 N 4
 $h_{NVS} = 15.7\text{--}16.8\text{ mm}$

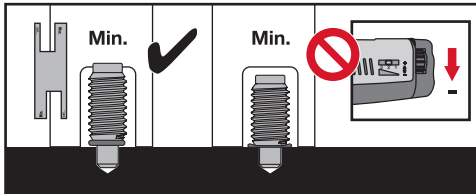

X-BT-MR-N M8/14 N 4
 $h_{NVS} = 25.7\text{--}26.8\text{ mm}$

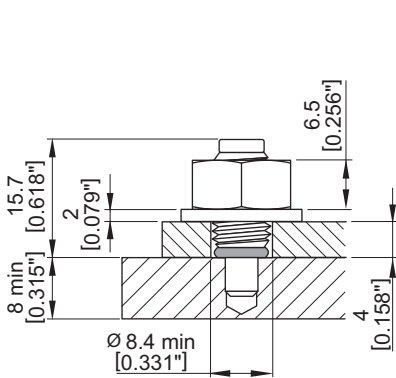
Installation

X-BT-MR-N M8/4 N 4

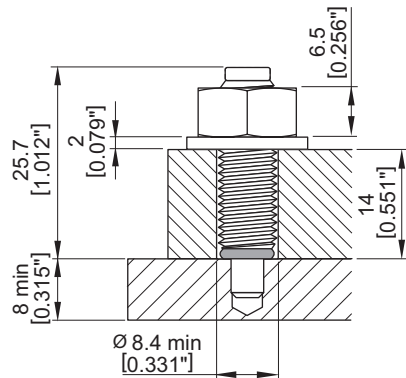

X-BT-MR-N M8/14 N 4

Pre-drill with **TX-BT 4/5.5** step shank drill bit

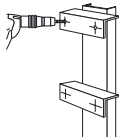

Pre-drill until the shoulder grinds a shiny ring (to ensure proper drilling depth)



Before fastener installation:

the drilled hole must be clear of liquids and debris. The area around the drilled hole must be free from liquids and debris.

Tighten using a screwdriver with torque clutch

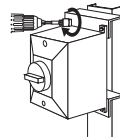

Tightening torque:
T_{rec} ≤ 8 Nm (5.9 ft-lb)!

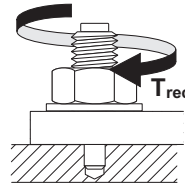

Hilti Torque tool X-BT 1/4"

Hilti screwdriver:	Torque setting:
SFC 14-A	6
SFC 18-A	3
SFC 22-A	5
SBT4-A22	5

These are abbreviated instructions which may vary by application.
ALWAYS review/follow the instructions accompanying the product.

X-BT-MF Composite threaded stud

Product data

Dimensions

X-BT-MF M/W 10/10 SN4

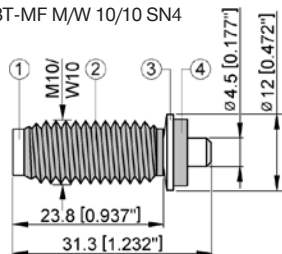

M10 nut

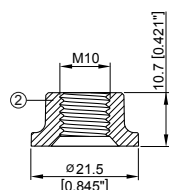

W10 nut

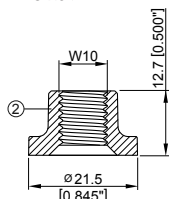

W10 = 3/8" UNC 2 thread

General information

Material specifications

- ① Shank: 1.4362 according to EN 10088-2
ASTM A240 UNS S32304
- ② Threaded sleeve and nut: Glass-fiber reinforced polyamide material - ISO 1874: PA6T/6I, MH, 12-190, GF50 (glass-fiber content: 50%), Flammability rating: UL94 HB
- ③ SN12 washer: S 31635
(X2CrNiMo 17-12-2, 1.4404)
- ④ Sealing washer: Chloroprene rubber CR 3.1107, black

Recommended fastening tools

DX 351-BT

See **X-BT-MF fastener program** in the next pages and **Tools and equipment** chapter for more details.

Approvals

ICC ESR-2347

Applications

Examples

Threaded stud applications especially for:

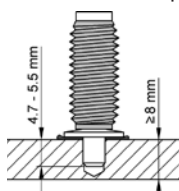

- High strength steel
- Coated steel structures
- Through penetration of base steel is not allowed

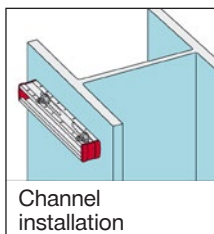

Channel installation

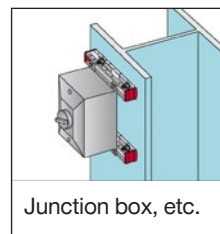

Junction box, etc.

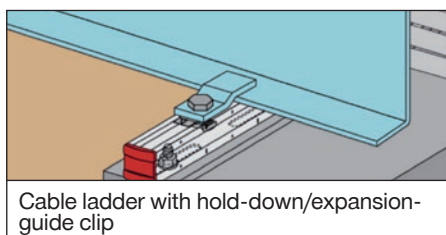

Cable ladder with hold-down/expansion-guide clip

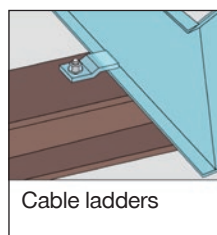

Cable ladders



Signage

Load data

Recommended loads

For structural steel (ultimate strength of base material $R_m \geq 350$ MPa)

Service temperature	-40°C to +60°C -40°F to +140°F	+60°C to +100°C +140°F to 212°F
Tension, N_{rec} [kN/lb]	1.5 / 340	1.0 / 225
Shear, V_{rec} [kN/lb]	2.2 / 500	1.4 / 315
Moment, M_{rec} [Nm/lbft]	8.2 / 6	8.2 / 6
Torque, T_{rec} [Nm/lbft]	$\leq 8 / \leq 5.9$	
During installation		
In service temp. range	-40°C to +100°C / -40°F to +212°F	
Installation temperature	-10°C to +60°C / 14°F to 140°F	

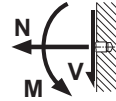

Example:

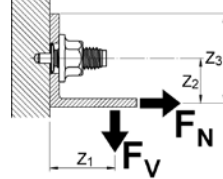

Conditions for recommended loads:

- Use with Hilti glass-fiber reinforced polyamide material nuts, M10 and W10 (Ⓜ according to General Information - Material specifications)
 - Not to be used with any additional washer which provide an axial force when deformed, e.g. spring or lock washer, etc.
 - Global factor of safety > 3 (based on 5% fractile value)
 - Minimum edge distance = 6 mm [$1/4"$].
 - Effect of base metal vibration and stress considered.
 - Redundancy (multiple fastening) must be provided.
 - The recommended loads in the table refer to the resistance of the individual fastening and may not be the same as the loads F_N and F_V acting on the fastened part.
- Note: If relevant, prying forces need to be considered in design, see example. Moment acting on fastener shank only in case of a gap between base and fastened material.
- **Minimum temperature for installation and adjustments = -10°C**

Design loads

For structural steel (ultimate strength of base material $R_m \geq 350$ MPa)

Service temperature	-40°C to +60°C -40°F to +140°F	+60°C to +100°C +140°F to +212°F
Tension, N_{Rd} [kN/lb]	2.0 / 450	1.35 / 300
Shear, V_{Rd} [kN/lb]	3.0 / 675	1.9 / 425
Moment, M_{Rd} [Nm/lbft]	18.4 / 13.6	18.4 / 13.6
In service temp. range	-40°C to +100°C / -40°F to +212°F	
Installation temperature	-10°C to +60°C / 14°F to 140°F	

Recommended interaction formula for combined loading

Combined loading situation	Interaction formula
V-N (shear and tension)	$\frac{V}{V_{rec}} + \frac{N}{N_{rec}} \leq 1.2$ with $\frac{V}{V_{rec}} \leq 1.0$ and $\frac{N}{N_{rec}} \leq 1.0$
V-M (shear and bending)	$\frac{V}{V_{rec}} + \frac{M}{M_{rec}} \leq 1.2$ with $\frac{V}{V_{rec}} \leq 1.0$ and $\frac{M}{M_{rec}} \leq 1.0$
N-M (tension and bending)	$\frac{N}{N_{rec}} + \frac{M}{M_{rec}} \leq 1.0$
V-N-M (shear, tension and bending)	$\frac{V}{V_{rec}} + \frac{N}{N_{rec}} + \frac{M}{M_{rec}} \leq 1.0$

Cyclic loading:

- Anchorage of X-BT-MF threaded stud in steel base material is not affected by cyclic loading.
- Fatigue strength is governed by fracture of the shank. Inquire at Hilti for test data if high cycle loading has to be considered in the design.

Application requirements

Thickness of base material

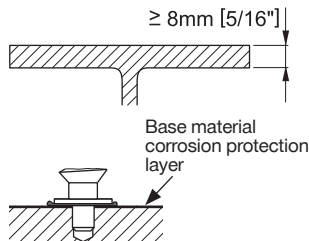

Where through penetration is not allowed*

Thickness of base material corrosion protection layer ≤ 0.4mm. For thicker coatings, please contact Hilti.

*Note: Corrosion protection may be compromised if base material thickness is less than 8mm.

Please contact Hilti for load recommendations if base material thickness is less than 8mm and through penetration allowed.

Thickness of fastened material

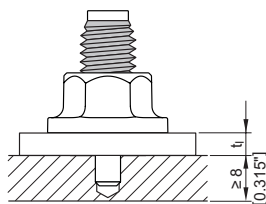

$2.0 \leq t_1 \leq 10.0$ mm
 $0.08'' \leq t_1 \leq 0.39''$

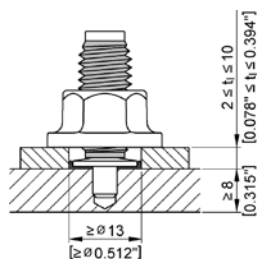

Fastened material hole \varnothing
 ≥ 13mm (0.51")

Spacing and edge distances

Edge distance: $\geq 6 \text{ mm}$

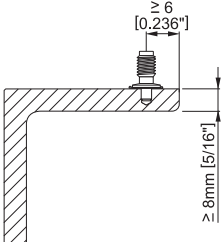

Spacing: $\geq 15 \text{ mm}$

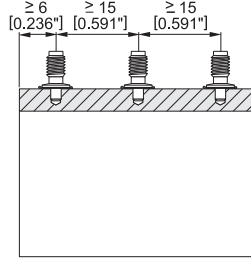

Durability

From a durability point of view, it can be assumed that the Hilti X-BT-MF system will have a lifetime over 20 years even in mildly corrosive environment (C3 environment according to EN-ISO 12944-2).

Corrosion information

For fastenings exposed to outdoor environments in mildly corrosive conditions where HDG coated parts are commonly specified or used.

Not for use in atmospheres with chlorides (marine atmospheres) or in heavily polluted environments (e.g. sulphur dioxide).

Vibration (Transportation, handling and base material vibration)

When installed according to instruction for use and fastening quality assurance, the X-BT-MF system (stud and Hilti glass-fiber reinforced polyamide material nuts) is resistant to transportation, handling and base material vibration.

The use of additional lock washer is not required. Lock washer will affect the integrity and functionality of the Hilti glass-fiber reinforced polyamide material nuts. Therefore additional lock or spring washers must not be used in combination with the X-BT-MF system.

For more information regarding vibration, please refer to “X-BT-MF Additional Technical Information”.

Application limit

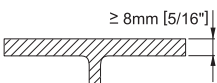

- $t_{II} \geq 8 \text{ mm}$ [$5/16''$] → No through penetration
- No limits with regards to steel strength

Fastener selection and system recommendation

Fastener program

Designation	Item no.	Tool designation
X-BT-MF M10/10 SN4	2083549	DX 351-BT
X-BT-MF W10/10 SN4	2083620	DX 351-BT

Accessories

Designation	Item no.	For use with
Socket X-NSD 1/4" – 16mm	2097397	X-BT-MF M10/10 SN4 and T-handle or Torque tool
Socket X-NSD 1/4" – 9/16"	2107229	X-BT-MF W10/10 SN4 and T-handle or Torque tool
T-handle X-NSD 1/4"	2115130	X-NSD sockets
Torque tool X-BT 1/4"	2119272	X-NSD sockets

Cartridge selection and tool energy setting

6.8/11 M high precision brown cartridge

Fine adjustment by installation tests on site

Fastening quality assurance

Fastening inspection

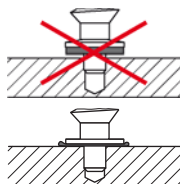
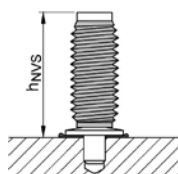

X-BT-MF

$h_{NVS} = 25.7 - 26.8 \text{ mm}$
 $= 1.012" - 1.055"$

Installation

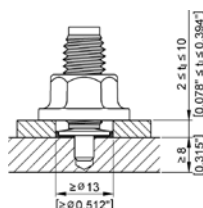

Fastened material hole
 $\phi \geq 13 \text{ mm (0.51")}$

Remark: for group fastenings subjected to shear loading the fastened material hole diameter should not exceed 14mm

Pre-drill with **TX-BT 4/7** step shank drill bit

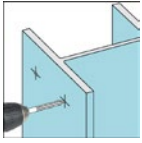

Pre-drill until the shoulder grinds a shiny ring (to ensure proper drilling depth)



Before fastener installation:

The drilled hole and the area around the drilled hole must be clear of liquids and debris.

Tighten using a screwdriver with torque clutch

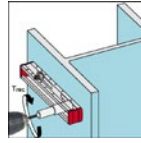

Tightening torque:
 $T_{rec} \leq 8 \text{ Nm}$ (5.9 ft-lb)!

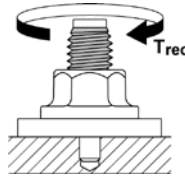

Hilti Torque tool X-BT 1/4"

Hilti screwdriver:	Torque setting:
SFC 14-A	6
SFC 18-A	3
SFC 22-A	3

These are abbreviated instructions which may vary by application.
ALWAYS review/follow the instructions accompanying the product.

S-BT Screw-in stainless steel and carbon steel threaded stud

Product data

Dimensions

S-BT-MR M10/15 SN 6
 S-BT-MR M10/15 SN 6 AL**)
 S-BT-MR W10/15 SN 6
 S-BT-MR W10/15 SN 6 AL**)

S-BT-MF M10/15 AN 6
 S-BT-MF W10/15 AN 6

S-BT-MR M10/15 SN 5***)
 S-BT-MR W10/15 SN 5***)

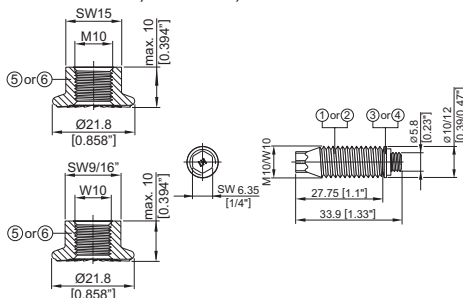

S-BT-MR M8/7 SN 6
 S-BT-MR M8/7 SN 6 AL**)
 S-BT-GR M8/7 SN 6*)
 S-BT-GR M8/7 SN 6 AL***)

S-BT-MF M8/7 AN 6
 S-BT-GF M8/7 AN 6*)

S-BT-MR M8/7 SN 5***)
 S-BT-GR M8/7 SN 5*)***)

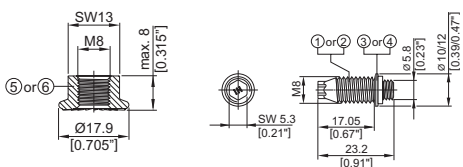

S-BT-MR M8/15 SN 6
 S-BT-MR M8/15 SN 6 AL**)

S-BT-MF M8/15 AN 6

S-BT-MR M8/15 SN 5***)

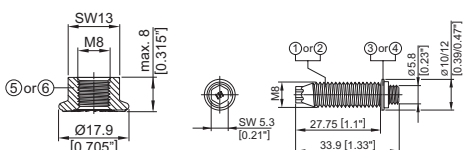

General information

Material specifications

- ① Threaded shank: Stainless steel (S-BT-_R)
"S 31803 (1.4462)"
zinc-coated
- ② Threaded shank: Carbon steel (S-BT-_F)
"1038 / duplex-coated"
- ③ SN12-R washers: Stainless steel (S-BT-_R)
"S 31635 (1.4404)"
- ④ AN10-F washers: Ø 10 mm [0.39"]
Aluminum (S-BT-_F)
- ⑤ Serrated flange nut*): Stainless steel (S-BT-MR)
grade A4 - 70/80
- ⑥ Serrated flange nut*): Carbon steel (S-BT-MF)
HDG, grade 8

Sealing ring of
 sealing washers: Chloroprene rubber CR
 3.1107, black
 resistant to UV, salt water,
 water, ozone, oils, etc.

Drilling tool, setting tool, accessories and inserts

Refer to section "Fastener selection and system recommendation" for more details.

Reports and type approvals

ICC-ES ESR-4185, ABS: 16-HS1550085-PDA, DNV-GL: TAS0000N6, LR: 16/00063, BV: 45116/A BV, Russian Maritime Register of Shipping: 16.40059.250



- *) S-BT-GR and S-BT-GF for grating fastening: package does not include serrated flange nuts
- ***) for use in aluminum base material
- ***) this items are not available at the moment

Applications

Examples

Multipurpose Fastening	Grating with X-FCM and X-FCS-R *)
S-BT-MR _____	S-BT-GR _____
S-BT-MF _____	S-BT-GF _____

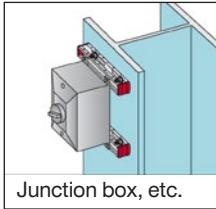

Junction box, etc.

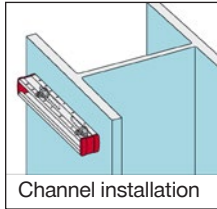

Channel installation



Signage

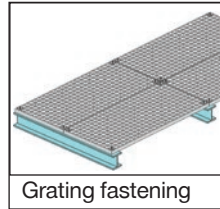

Grating fastening

*) Load data, application requirements, corrosion information, fastener selection, system recommendation, material specification and coating refer to section X-FCM Grating Fastening System on X-FCS-R Grating Fastening System in the Direct Fastening Technology Manual.

Load data

Recommended loads

	S-BT-_____6			S-BT-_____5 *)			
	Steel S235 A36	Steel S355 Grade 50	Aluminum $f_u \geq 270$ MPa	Steel S235 A36	Steel S355 Grade 50	Steel S235 A36	Steel S355 Grade 50
Drill hole type and base material thickness	Pilot hole, $t_{II} \geq 6 \text{ mm}$ [0.24"] Drill through hole, 5 mm [0.20"] $\leq t_{II} < 6 \text{ mm}$ [0.24"]			Drill through hole, 3 mm [0.12"] $\leq t_{II} < 5 \text{ mm}$ [0.20"]		Pilot hole, 5 mm [0.20"] $\leq t_{II} < 6 \text{ mm}$ [0.24"]	
Tension, N_{rec} [kN/lb]	1.8 / 405	2.3 / 520	1.0 / 225	1.0 / 225	1.3 / 290	1.0 / 225	1.3 / 290
Shear, V_{rec} [kN/lb]	2.6 / 585	3.2 / 720	1.5 / 340	1.5 / 340	1.9 / 430	1.5 / 340	1.9 / 430
Moment, M_{rec} [Nm/lbft]	7.0 / 5.2	7.0 / 5.2	4.8 / 3.5	7.0 / 5.2	7.0 / 5.2	6.2 / 4.6	6.2 / 4.6

Design resistance

	S-BT-_____6			S-BT-_____5 *)			
	Steel S235 A36	Steel S355 Grade 50	Aluminum $f_u \geq 270$ MPa	Steel S235 A36	Steel S355 Grade 50	Steel S235 A36	Steel S355 Grade 50
Drill hole type and base material thickness	Pilot hole, $t_{II} \geq 6 \text{ mm}$ [0.24"] Drill through hole, 5 mm [0.20"] $\leq t_{II} < 6 \text{ mm}$ [0.24"]			Drill through hole, 3 mm [0.12"] $\leq t_{II} < 5 \text{ mm}$ [0.20"]		Pilot hole, 5 mm [0.20"] $\leq t_{II} < 6 \text{ mm}$ [0.24"]	
Tension, N_{Rd} [kN/lb]	2.5 / 560	3.2 / 720	1.4 / 315	1.4 / 315	1.8 / 405	1.4 / 315	1.8 / 405
Shear, V_{Rd} [kN/lb]	3.6 / 810	4.5 / 1010	2.1 / 470	2.1 / 470	2.7 / 610	2.1 / 470	2.7 / 610
Moment, M_{Rd} [Nm/lbft]	9.8 / 7.2	9.8 / 7.2	6.7 / 4.9	9.8 / 7.2	9.8 / 7.2	8.7 / 6.4	8.7 / 6.4

*) this items are not available at the moment

Conditions for recommended loads:

- Use S-BT-MR and S-BT-MF (multipurpose fastening) only with the supplied Hilti serrated flange nuts M8, M10, W10 (Ⓢ or Ⓣ) as per according to General Information – Material specifications)
- Global factor of safety Ω for static pull-out and static shear ≥ 3 (based on 5% fracture ultimate test value)
- Minimum edge distance = 6 mm [0.24"], spacing ≥ 18 mm [0.709"]
- Effect of base metal vibration and stress (e.g. areas with tensile stress) considered.
- Redundancy (multiple fastening) must be provided.
- If eccentric loading exists (e.g. use of an angle clip), moments caused by off-center loading must be considered.

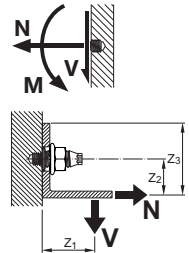

Recommended interaction formula for combined loading – steel and aluminum base material

$$\mathbf{V-N} \text{ (shear and tension)} \quad \frac{V}{V_{rec}} + \frac{N}{N_{rec}} \leq 1.2 \text{ with } \frac{V}{V_{rec}} \leq 1.0 \text{ and } \frac{N}{N_{rec}} \leq 1.0$$

$$\mathbf{V-M} \text{ (shear and bending)} \quad \frac{V}{V_{rec}} + \frac{M}{M_{rec}} \leq 1.2 \text{ with } \frac{V}{V_{rec}} \leq 1.0 \text{ and } \frac{M}{M_{rec}} \leq 1.0$$

$$\mathbf{N-M} \text{ (tension and bending)} \quad \frac{N}{N_{rec}} + \frac{M}{M_{rec}} \leq 1.0$$

$$\mathbf{V-N-M} \text{ (shear, tension and bending)} \quad \frac{V}{V_{rec}} + \frac{N}{N_{rec}} + \frac{M}{M_{rec}} \leq 1.0$$

Cyclic loading:

S-BT threaded studs are only to be used for fastenings subject to static or quasi-static loading. Inquire at Hilti for test data if cyclic loading has to be considered in the design.

Application Requirements

Base material thickness t_{II} and type of bore hole

S-BT-MR M8/7 SN 6	S-BT-MR M8/15 SN 6	S-BT-MR M10/15 SN 6	S-BT-MR M8/7 SN 5 **)
S-BT-MR M8/7 SN 6 AL*)	S-BT-MR M8/15 SN 6 AL*)	S-BT-MR M10/15 SN 6 AL*)	S-BT-MR M8/15 SN 5 **)
S-BT-MF M8/7 AN 6	S-BT-MF M8/15 AN 6	S-BT-MF M10/15 AN 6	S-BT-GR M8/7 SN 5 **)
S-BT-GR M8/7 SN 6		S-BT-MR W10/15 SN 6	S-BT-MR M10/15 SN 5 **)
S-BT-GR M8/7 SN 6 AL*)		S-BT-MR W10/15 SN 6 AL*)	S-BT-MR W10/15 SN 5 **)
S-BT-GF M8/7 AN 6		S-BT-MF W10/15 AN 6	

Pilot hole

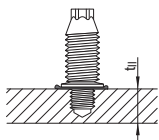

Base material thickness
steel and aluminum:
 $t_{II} \geq 6 \text{ mm}$

Drill through hole

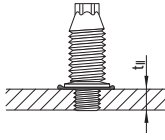

Base material thickness
steel: $3 \text{ mm} \leq t_{II} < 6 \text{ mm}$
aluminum: $5 \text{ mm} \leq t_{II} < 6 \text{ mm}$

Pilot hole

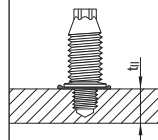

Base material
thickness steel:
 $5 \text{ mm} \leq t_{II} < 6 \text{ mm}$

*) for use in aluminum base material

**) this items are not available at the moment

Thickness of base material corrosion protection layer $\leq 0.8 \text{ mm}$ [0.0315"].

For thicker coatings, please contact Hilti.

Base material
corrosion
protection
layer

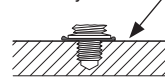

Thickness of fastened material t_1

S-BT-____/7____ 1.6 mm [0.063"] $\leq t_1 \leq 7.0 \text{ mm}$ [0.28"]

S-BT-____/15____ 1.6 mm [0.063"] $\leq t_1 \leq 15.0 \text{ mm}$ [0.59"]

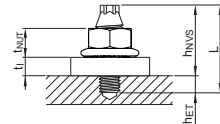

Spacing & edge distances

Edge distance: $\geq 6 \text{ mm}$ [0.24"]

Spacing: $\geq 18 \text{ mm}$ [0.709"] for all S-BT M8

$\geq 22 \text{ mm}$ [0.866"] for all S-BT M10 and S-BT W10

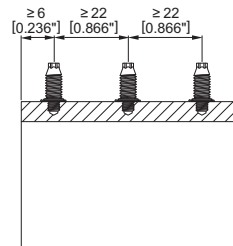
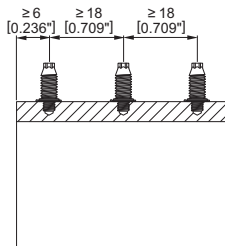
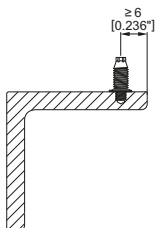

Corrosion information

The S-BT stainless steel fasteners are made from the duplex stainless steel type 1.4462, which is equivalent to AISI 316 (A4) steel grade. This grade of stainless steel is classified in the corrosion resistance class IV according to DIN EN 1993-1-4:2015, which makes the material suitable for aggressive environments like in coastal and offshore applications.

The microstructures of duplex stainless steels consist of a mixture of austenite and ferrite phases. Compared to the austenitic stainless steel grades, duplex stainless steels are magnetic. The surface of the S-BT stainless steel fasteners is zinc-coated (anti-friction coating) in order to reduce the thread forming torque when the stud is screwed in into the base material.

The coating of the carbon steel S-BT fasteners consists of an electroplated Zn-alloy for cathodic protection and a top coat for chemical resistance (Duplex-coating). The thickness of the coating is 35 µm. The use of this coating is limited to the corrosion category C1, C2 and C3 according to the standard EN ISO 9223. For higher corrosion categories stainless steel fasteners should be used.

In case of a **drill through hole or a pilot hole in thin base material**, rework of the coating on the back side of the plate/profile may be needed.

	S-BT-_____AN 6		S-BT-_____SN 6		S-BT-_____SN 5 ⁴⁾	
Corrosivity category C	C3 medium corrosive		C5 very high corrosive		C5 very high corrosive	
Drill hole type and base material thickness t_{b1} ¹⁾	Topside protection	Backside protection	Topside protection	Backside protection	Topside protection	Backside protection
Drill through hole 3 mm [0.12"] ≤ t_{b1} < 6 mm [0.24"]	✓	x ²⁾	✓	x ²⁾	n.a.	n.a.
Pilot hole 5 mm [0.20"] ≤ t_{b1} < 6 mm [0.24"]	n.a.	n.a.	n.a.	n.a.	✓	✓ ³⁾
Pilot hole 6 mm [0.24"] ≤ t_{b1} < 7 mm [0.28"]	✓	✓	✓	✓ ³⁾	✓	✓
Pilot hole t_{b1} ≥ 7 mm [0.28"]	✓	✓	✓	✓	✓	✓

1) Real base material thickness, not nominal material thickness or material thickness with coating.

2) Damage of the coating on the back side of the plate/profile require a rework of the coating.

3) Damage of the coating on the back side of the plate / profile require a rework of the coating, if the drilling tools SF BT 22-A or SF BT 18-A were used for drilling the bore hole. If the tool SBT 4-A22 was used for drilling the bore hole, no damage of the coating on the back side of the plate / profile will occur.

4) This items are not available at the moment.

Application limit

The base material is limited to steel grade with a maximum tensile strength $f_u = 630$ MPa [91 ksi].

The minimum tensile strength of steel is $f_u \geq 340$ MPa [49 ksi].

The minimum tensile strength of aluminum is $f_u \geq 270$ MPa [39 ksi].

Minimum thickness of base material t_{II} : refer to section “Application Requirements”.

Maximum thickness of base material t_{II} : no limits.

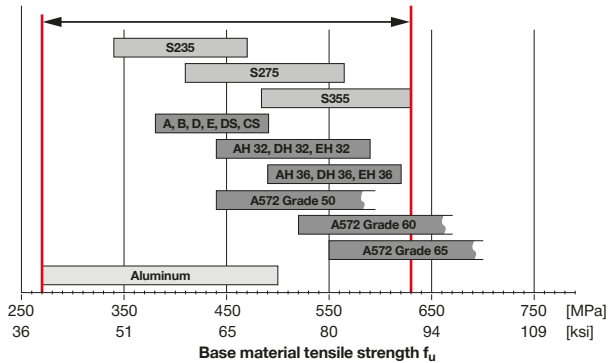

Fastener selection and system recommendation

	Fastener	Drilling tool	Setting tool	Drill bit	Depth gauge
Stainless steel	S-BT-MR M8/7 SN 5 *)	SBT 4-A22, SF BT 18-A or SF BT 22-A	SBT 4-A22, SFC 18-A or SFC 22-A		S-DG BT M8/7 Short 5 *)
	S-BT-MR M8/15 SN 5 *)			TS-BT 4.3-74 S *)	S-DG BT M8/15 Long 5 *)
	S-BT-GR M8/7 SN 5 *)				S-DG BT M8/7 Short 5 *)
	S-BT-MR M8/7 SN 6			TS-BT 5.5-74 S	
	S-BT-MR M8/7 SN 6 AL			TS-BT 5.5-74 AL	S-DG BT M8/7 Short 6
	S-BT-MR M8/15 SN 6			TS-BT 5.5-74 S	
	S-BT-MR M8/15 SN 6 AL			TS-BT 5.5-74 AL	S-DG BT M8/15 Long 6
	S-BT-MR M8/7 SN 6			TS-BT 5.5-74 S	
	S-BT-GR M8/7 SN 6 AL			TS-BT 5.5-74 AL	S-DG BT M8/7 Short 6
	S-BT-MR M10/15 SN 5 *)				
	S-BT-MR W10/15 SN 5 *)			TS-BT 4.3-74 S *)	S-DG BT M10-W10/15 Long 5 *)
	S-BT-MR M10/15 SN 6			TS-BT 5.5-74 S	
	S-BT-MR M10/15 SN 6 AL			TS-BT 5.5-74 AL	
	S-BT-MR W10/15 SN 6			TS-BT 5.5-74 S	S-DG BT M10-W10/15 Long 6
S-BT-MR W10/15 SN 6 AL	TS-BT 5.5-74 AL				
Carbon steel	S-BT-GF M8/7 AN 6				S-DG BT M8/7 Short 6
	S-BT-MF M8/7 AN 6				
	S-BT-MF M8/15 AN 6			TS-BT 5.5-74 S	S-DG BT M8/15 Long 6
	S-BT-MF M10/15 AN 6				
	S-BT-MF W10/15 AN 6				S-DG BT M10-W10/15 Long 6
	S-BT-MF W10/15 AN 6				

*) this items are not available at the moment

Fastener quality assurance

In order to ensure the exact screw-in depth and a proper compressed sealing washer, the S-BT studs have to be installed with the appropriate depth gauge. With this tool the screw-in depth can be adjusted in a range of 0 - 1.5 mm (3 steps, 0.5mm per step).

The S-CC BT calibration card is needed to check the initial stand-off of the S-BT stud and to adjust/calibrate the S-DG depth gauge. After finding the right adjustment level for the S-DG depth gauge, the gauge can be adjusted and the studs can be installed without additional check of the S-DG depth gauge.

The depth gauge has to be re-adjusted (calibrated) at following times:

- Start of the installation process
- Change of the working position (upwards, downwards, horizontal) and base material (thickness, strength, type)
- Installer change
- After each packaging respectively after the installation of 100 S-BT studs

The lifetime of the S-DG BT depth gauge is ≥ 1000 settings.

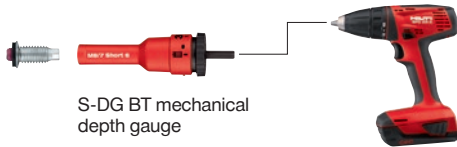

S-DG BT mechanical depth gauge

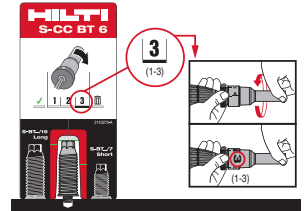

Design and functionality of the mechanical calibration card S-CC BT

Fastening inspection

The installer is responsible for the correct setting of the S-BT studs.

For the periodical verification of the correct stud stand-off the S-CG BT check gauge can be used.

Verify stud stand-off h_{NVS} with check gauge S-CG BT

S-BT-___/7___6 $h_{NVS} = 18.6 \text{ mm to } 19.1 \text{ mm [0.732" to 0.752"]}$

S-BT-___/15___6 $h_{NVS} = 29.3 \text{ mm to } 29.8 \text{ mm [1.153" to 1.173"]}$

S-BT-___/7___5 *) $h_{NVS} = 19.6 \text{ mm to } 20.1 \text{ mm [0.772" to 0.791"]}$

S-BT-___/15___5 *) $h_{NVS} = 30.3 \text{ mm to } 30.8 \text{ mm [1.193" to 1.213"]}$

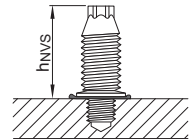

*) this items are not available at the moment

Designation	Product name	Comment
S-DG BT M8/7 Short 6	Depth gauge	for exact setting of S-BT M8/7 _N 6
S-DG BT M8/15 Long 6	Depth gauge	for exact setting of S-BT M8/15 _N 6
S-DG BT M10-W10/15 Long 6	Depth gauge	for exact setting of S-BT M10/W10 _N 6
S-CC BT 6	Calibration card	for calibration of the depth gauge (short/long studs)
S-CG BT /7 Short 6	Check gauge	for verification of the stand-off for short studs (7 mm)
S-CG BT /15 Long 6	Check gauge	for verification of the stand-off for long studs (15 mm)

Installation

S-BT fasteners made of stainless steel with washer- \varnothing 12mm (S-BT-_R)

Fastened material hole $\varnothing \geq 13$ mm [0.51"]

S-BT fasteners made of carbon steel with washer- \varnothing 10mm (S-BT-_F)

Fastened material hole $\varnothing \geq 11$ mm [0.43"]

Important: for group fastenings subjected to shear loading the fastened material hole diameter should not exceed 14 mm [0.55"] (S-BT-_R) and 12 mm [0.47"] (S-BT-_F) respectively.

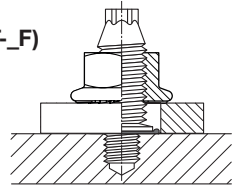

Installation

1 Mark location for each fastening	2 Pre-drill with TS-BT stepped drill bit	3 Screw-in S-BT studs into drilled hole	4 Fasten channel on base material	5 Fasten accessory on channel																		
	<p>Usage of SBT 4-A22, SF BT 18-A or SF BT 22-A. Pre-drill until the shoulder grinds a shiny ring to assure proper drilling depth.</p> <p>Before fastener installation: The drilled hole and the area around the drilled hole must be clear of liquids and debris.</p>	<p>Usage of SBT 4-A22, SFC 18-A or SFC 22-A in combination with the calibrated depth gauge S-DG BT.</p> <p>Verify stud stand-off h_{NVS} with check gauge S-CG BT</p> <p>Sealing washer must be properly compressed!</p>	<p>Position channel on S-BT studs and hold in place. Tighten the nuts with the suited tightening torque T_{rec}.</p> <p>T_{rec} ref. to table below. Tighten the nuts using</p> <ul style="list-style-type: none"> • SBT 4-A22, SFC 18-A / 22-A with socket S-NS • Torque tool X-BT 1/4" (8 Nm) or S-BT 1/4" (5 Nm) • Torque wrench <table border="1" data-bbox="621 1109 784 1244"> <thead> <tr> <th></th> <th colspan="2">T_{rec}</th> </tr> <tr> <th>Hilti screw-driver:</th> <th>5 Nm</th> <th>8 Nm</th> </tr> <tr> <th></th> <th colspan="2">setting:</th> </tr> </thead> <tbody> <tr> <td>SBT 4-A22</td> <td>4</td> <td>5</td> </tr> <tr> <td>SFC 18-A</td> <td>4</td> <td>5</td> </tr> <tr> <td>SFC 22-A</td> <td>4</td> <td>5</td> </tr> </tbody> </table>		T_{rec}		Hilti screw-driver:	5 Nm	8 Nm		setting:		SBT 4-A22	4	5	SFC 18-A	4	5	SFC 22-A	4	5	<p>Tighten the bolts with the suited tightening torque T_{rec} (see IFU of the Hilti wing nuts).</p>
	T_{rec}																					
Hilti screw-driver:	5 Nm	8 Nm																				
	setting:																					
SBT 4-A22	4	5																				
SFC 18-A	4	5																				
SFC 22-A	4	5																				
<p>Important: These are abbreviated instructions which may vary by application. ALWAYS review / follow the instructions for use (IFU) accompanying the product. In case of a drill through hole, rework of the coating on the back side of the plate / profile may be needed.</p>																						

Tightening torque serrated flange nut

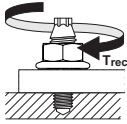

Drill hole type and base material thickness	S-BT- 6			S-BT- 5 *)			
	Pilot hole, $t_{H1} \geq 6 \text{ mm [0.24"]}$ Drill through hole, $5 \text{ mm [0.20"]} \leq t_{H1} < 6 \text{ mm [0.24"]}$			Drill through hole, $3 \text{ mm [0.12"]} \leq t_{H1} < 5 \text{ mm [0.20"]}$		Pilot hole, $5 \text{ mm [0.20"]} \leq t_{H1} < 6 \text{ mm [0.24"]}$	
Base material	Steel S235 A36	Steel S355 Grade 50	Aluminum $f_u \geq 270 \text{ MPa}$	Steel S235 A36	Steel S355 Grade 50	Steel S235 A36	Steel S355 Grade 50
Tightening torque serrated flange nut $T_{rec} \text{ [Nm/lbft]}$	8 / 5.9	8 / 5.9	5 / 3.6	5 / 3.6	5 / 3.6	5 / 3.6	5 / 3.6

Important: The tightening torque (T_{rec}) for the serrated flange nut is dependent on the stud type, the base material type and thickness, and the drill hole type. Exceeding the tightening torque (T_{rec}) leads to damage of the S-BT stud's anchorage with negative impact on the load values and the sealing function.

*) this items are not available at the moment

Fastener program

Designation	Item no.	Product name	Comment	Application
S-BT-GF M8/7 AN 6	2140527	Threaded stud	use with X-FCM grating disc	Grating
S-BT-MF M8/7 AN 6	2139174	Threaded stud	package includes serrated flange nut	Multipurpose
S-BT-MF M8/15 AN 6	2148618	Threaded stud	package includes serrated flange nut	Multipurpose
S-BT-MF M10/15 AN 6	2140528	Threaded stud	package includes serrated flange nut	Multipurpose
S-BT-MF W10/15 AN 6	2139173	Threaded stud	package includes serrated flange nut	Multipurpose
S-BT-GR M8/7 SN 5 *)	2149240	Threaded stud	use with X-FCM grating disc	Grating
S-BT-GR M8/7 SN 6	2140529	Threaded stud	use with X-FCM grating disc	Grating
S-BT-GR M8/7 SN 6 AL	2140742	Threaded stud	use with X-FCM grating disc	Grating
S-BT-MR M8/7 SN 5 *)	2139171	Threaded stud	package includes serrated flange nut	Multipurpose
S-BT-MR M8/7 SN 6	2139172	Threaded stud	package includes serrated flange nut	Multipurpose
S-BT-MR M8/7 SN 6 AL	2140743	Threaded stud	package includes serrated flange nut	Multipurpose
S-BT-MR M8/15 SN 5 *)	2148622	Threaded stud	package includes serrated flange nut	Multipurpose
S-BT-MR M8/15 SN 6	2148612	Threaded stud	package includes serrated flange nut	Multipurpose
S-BT-MR M8/15 SN 6 AL	2148614	Threaded stud	package includes serrated flange nut	Multipurpose
S-BT-MR M10/15 SN 5 *)	2148623	Threaded stud	package includes serrated flange nut	Multipurpose
S-BT-MR M10/15 SN 6	2140740	Threaded stud	package includes serrated flange nut	Multipurpose
S-BT-MR M10/15 SN 6 AL	2140744	Threaded stud	package includes serrated flange nut	Multipurpose
S-BT-MR W10/15 SN 5 *)	2148624	Threaded stud	package includes serrated flange nut	Multipurpose
S-BT-MR W10/15 SN 6	2140741	Threaded stud	package includes serrated flange nut	Multipurpose
S-BT-MR W10/15 SN 6 AL	2140745	Threaded stud	package includes serrated flange nut	Multipurpose
TS-BT 5.5-74 S	2143137	Stepped drill bit	for base material steel	
TS-BT 5.5-74 AL	2143138	Stepped drill bit	for base material aluminum	
TS-BT 4.3-74 S *)	2143139	Stepped drill bit	for base material steel	
S-DG BT M8/7 Short 6	2143260	Depth gauge	for exact setting of the S-BT	
S-DG BT M10-W10/15 Long 6	2143261	Depth gauge	for exact setting of the S-BT	
S-DG BT M8/15 Long 6	2148575	Depth gauge	for exact setting of the S-BT	
S-DG BT M8/7 Short 5 *)	2149241	Depth gauge	for exact setting of the S-BT	
S-DG BT M10-W10/15 Long 5 *)	2149242	Depth gauge	for exact setting of the S-BT	
S-DG BT M8/15 Long 5 *)	2149243	Depth gauge	for exact setting of the S-BT	
S-CC BT 6	2143270	Calibration card	for calibration of the depth gauge	
S-BT 1/4" - 5 Nm	2143271	Torque tool	manual torque tool (5 Nm)	
X-BT 1/4" - 8 Nm	2119272	Torque tool	manual torque tool (8 Nm)	
S-NS 13 C 95/3 3/4"	2149244	Nut setter	for serrated flange nut M8	
S-NS 15 C 95/3 3/4"	2149245	Nut setter	for serrated flange nut M10	
S-NS 9/16" C 95/3 3/4"	2149246	Nut setter	for serrated flange nut W10	

*) this items are not available at the moment

X-ST-GR Stainless steel threaded stud for fastening to steel

Product data

Dimensions

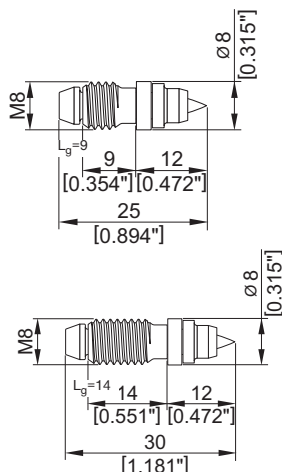

General information

Material specifications

Shank: P558 (CrMnMo alloy)

$f_u \geq 2000 \text{ N/mm}^2$

Threaded sleeve: A4 (AISI 316)

Washers: polyethylene

Recommended fastening tools

DX 460, DX 5 with fastener guide X-5-460-F8N15

DX 76 PTR with fastener guide X-76-F-8-GR-PTR

See **X-ST-GR fastener program** in the next pages and **Tools and equipment** chapter for more details.

Approvals

ICC ESR-2347

ABS

Applications

Examples

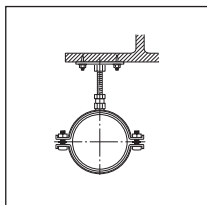

Base plates for pipe rings

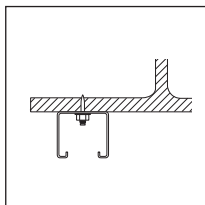

Installation rails

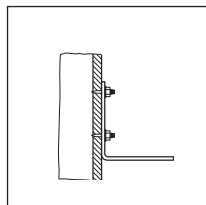

Facade brackets

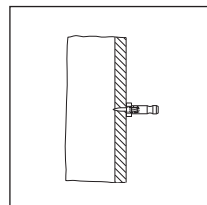

Special purpose connections

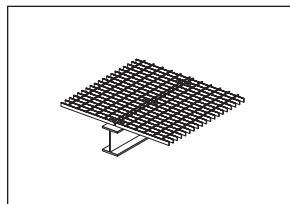

Grating

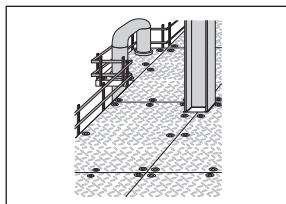

Checker plate

Load data

Recommended loads

N_{rec} [kN]	V_{rec} [kN]	M_{rec} [Nm]
1.8	1.8	5.5

Condition:

- For safety-relevant fastenings sufficient redundancy of the entire system is required.

Arrangements to reduce or prevent moment on shank:

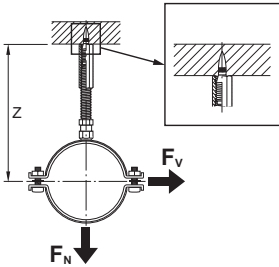

Application requirements

Thickness of base material

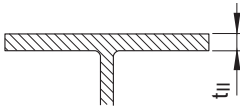

$$t_{II} \geq 6 \text{ mm}$$

Thickness of fastened material

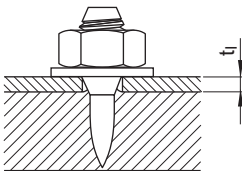

$$t_I \leq L_g - t_{washer} - t_{nut}$$

$$t_I \leq 10 \text{ mm for X-ST-GR M8/10 P8}$$

$$t_I \leq 5 \text{ mm for X-ST-GR M8/5 P8}$$

Spacing and edge distances (mm)

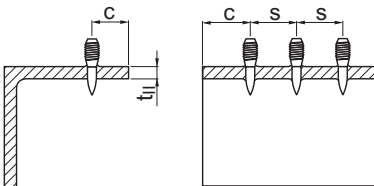

$$c, s \geq 15 \text{ mm}$$

Corrosion information

For fastenings exposed to outdoor environments in mildly corrosive conditions where HDG coated parts are commonly specified or used. Not for use in atmospheres with chlorides (marine atmospheres) or in heavily polluted environments (e.g. sulphur dioxide).

Application limit

Steel: DX 460, DX 5

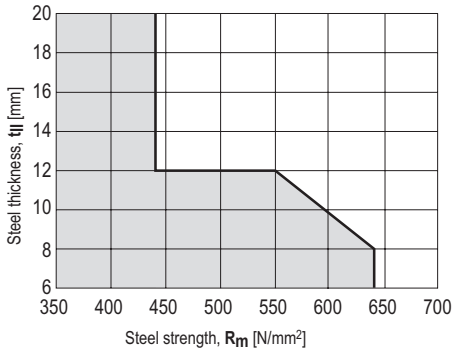

Steel: DX 76 PTR

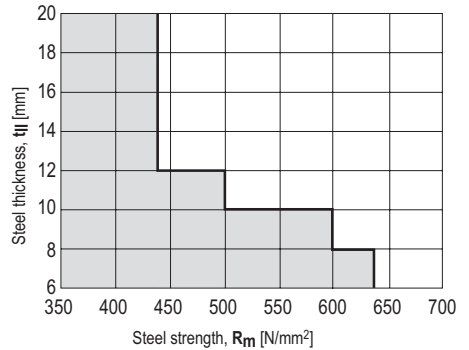

Fastener selection and system recommendation

Fastener program

Designation	Item no.	L_g [mm]
X-ST-GR M8/5 P8	2122209	9
X-ST-GR M8/10 P8	2122460	14

Cartridge selection

DX 460, DX 5

6.8/11M black or red cartridge

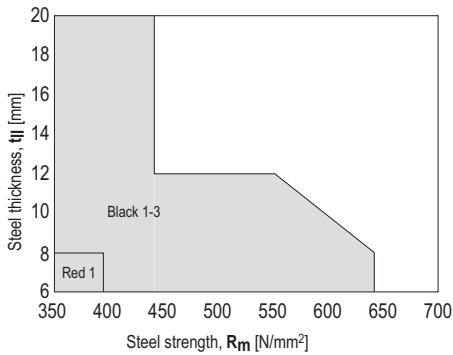

DX 76 PTR

6.8/18M yellow or red cartridge

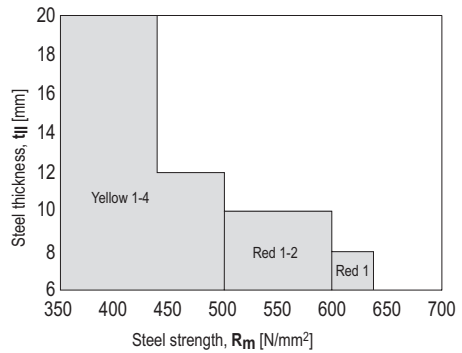

Fastening quality assurance

Fastening inspection

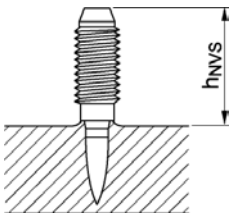

Fastener	h_{Nvs} [mm]
X-ST-GR M8/5 P8	12.0 – 15.0
X-ST-GR M8/10 P8	17.0 – 20.0

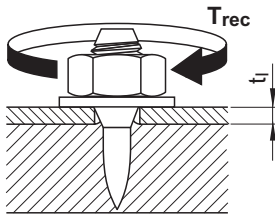
Installation

Tightening torque
 $T_{rec} = 8.5 \text{ Nm}$

X-CR M Stainless steel threaded stud for fastening to concrete and steel

Product data

Dimensions

X-CR M8-__-42 P8 (DX-Kwik)

Threaded sleeve: A4 (AISI 316)

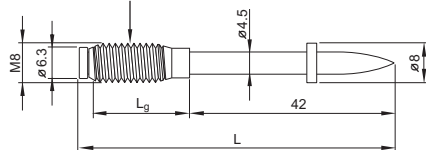

X-CR M8-15-12 FP10

Threaded sleeve: A4 (AISI 316)

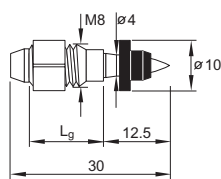

X-CRM8-9-12 P8

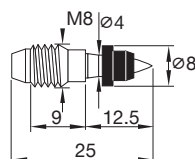

General information

Material specifications

Shank:	CrNiMo alloy $f_u \geq 1800 \text{ N/mm}^2$ (49 HRC)
Threaded sleeve:	A4 (AISI 316)
Zinc coating to improve anchoring in concrete (X-CR M8-__-42):	5–13 μm
Washers/ guidance sleeve:	polyethylene

Recommended fastening tools

DX 460, DX 5, DX 36, DX 2,
DX 76, DX 76 PTR

See **X-CR M fastener program** in the next pages and **Tools and equipment** chapter for more details.

Approvals

DIBt (Germany):	X-CR M8-__-42 P8 (DX-Kwik)
ICC ESR-2347:	X-CR M8-9-12,
ABS, LR:	X-CR M8-15-12



Note: technical data presented in these approvals and design guidelines reflect specific local conditions and may differ from those published in this handbook.

Applications

Examples

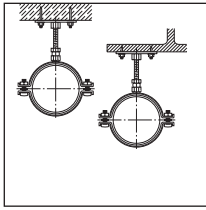

Base plates for pipe rings

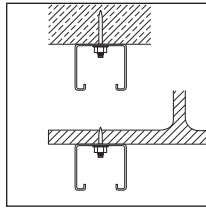

Installation rails

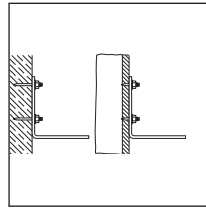

Facade brackets

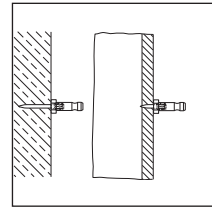

Special purpose connections

Load data

Recommended loads

Fastening to steel

	N_{rec} [kN]	V_{rec} [kN]	M_{rec} [Nm]
X-CR M8	1.8	1.8	5.5

Conditions:

- For safety-relevant fastenings sufficient redundancy of the entire system is required.

Fastening to concrete – DX-Kwik method (pre-drilling)

	$N_{rec,1}$ [kN]	$N_{rec,2}$ [kN]	V_{rec} [kN]	M_{rec} [Nm]
X-CR M8-__-42 P8	3.0	0.9	3.0	5.5

Conditions:

- $N_{rec,1}$: concrete in compressive zone
- $N_{rec,2}$: concrete in tension zone
- $f_{cc} \geq 20 \text{ N/mm}^2$
- A sufficient redundancy has to be ensured, that the failure of a single fastening will not lead to collapse of the entire system.
- Observance of all pre-drilling requirements

Arrangements to reduce or prevent moment on shank:

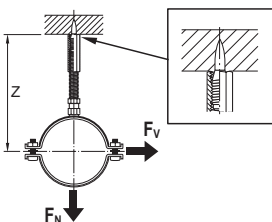

Application requirements

Thickness of base material

Concrete – DX-Kwik

$h_{\min} = 100 \text{ mm}$

Steel

$t_{II} \geq 6 \text{ mm}$

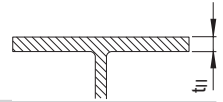

Thickness of fastened material

X-CR M8

$t_I \leq L_g - t_{\text{washer}} - t_{\text{nut}} \approx \text{up to } 13.0 \text{ mm}$

Spacing and edge distances (mm)

Fastening to steel

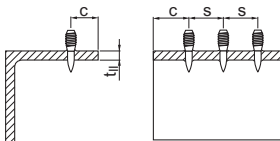

$c, s \geq 15 \text{ mm}$

Fastening to concrete

Pairs

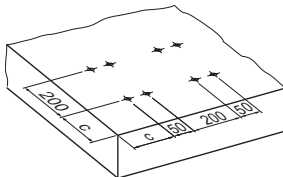

Reinforced * Non-reinforced

c 100 150

Row along edge

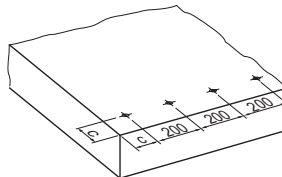

Reinforced * Non-reinforced

c 80 150

General (e.g. group of fasteners)

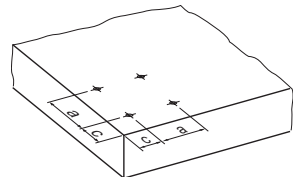

Reinforced * Non-reinforced

c 80 150

a 80 100

* Minimum $\varnothing 6$ reinforcing steel continuous along all edges and around all corners. Edge bars must be enclosed by stirrups

Corrosion information

For fastenings exposed to weather or other corrosive conditions. Not for use in highly corrosive surroundings like swimming pools or highway tunnels.

Application limits

Concrete:

No general restrictions existent. Limitations are dependent on application and user requirements.

Steel: DX 76, DX 76 PTR

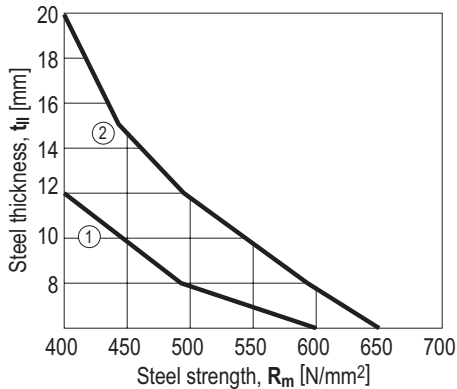

- ① X-CRM8-15-12 FP10 / DX 76 (impact)
- ② X-CRM8-15-12 FP10 / DX 76 (co-acting)

Fastener selection and system recommendation

Fastener program

Fastened thickness $t_{f,max}$ [mm]	Fastener Designation ¹⁾	Item no.	L_g [mm]	L_s [mm]	Tools
Base material concrete, DX-Kwik method					
5.0	X-CR M8-14-42 P8	255911	14	42	DX 460, DX 5, DX 36, DX 2
13.0	X-CR M8-22-42 P8	255910	22	42	DX 460, DX 5, DX 36, DX 2
Base material steel					
6.0	X-CR M8-9-12 FP10	372032	9	12.5	DX 76, DX 76 PTR, DX 5, DX 460
6.0	X-CR M8-15-12 FP10	372 034	15	12.5	DX 76, DX 76 PTR, DX 5, DX 460

¹⁾ Type threading: M = metric

Cartridge selection and tool energy setting

Base material	Designation	Tool
Concrete	6.8/11M yellow or red cartridge	DX 460, DX 5, DX 36, DX 2
Steel	6.8/11M red cartridge	DX 460, DX 5
Steel	6.8/18M cartridge	DX 76, DX 76 PTR

Tool energy adjustment by setting tests on site.

Fastening quality assurance

Fastening inspection

Fastening to concrete

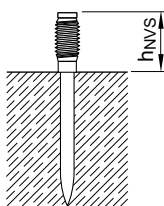

DX-Kwik (pre-drilling)

Fastener	h_{NVS} [mm]
X-CR M8-14-42 P8	12.0 – 16.0
X-CR M8-22-42 P8	20.0 – 24.0

Fastening to steel

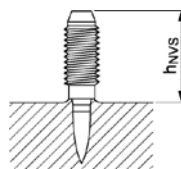

Fastener	h_{NVS} [mm]
X-CR M8-9-12 FP10	12.0 – 15.0
X-CR M8-15-12 FP10	17.0 – 20.0

Installation

Fastening to concrete

DX-Kwik (pre-drilling)

X-CR M8- -42 P8

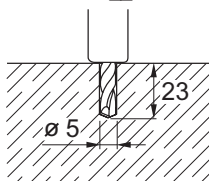

Pre-drill with drill bit
TE-C-5/23B (Item-no.
28557) or TE-C-5/23
(Item no. 00061787)

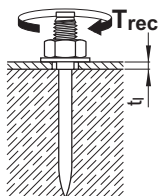

Tightening torque
 $T_{rec} = 10 \text{ Nm}$

Fastening to steel

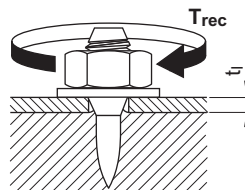

Tightening torque
X-CR M8 $T_{rec} = 8.5 \text{ Nm}$

These are abbreviated instructions which may vary by application.
ALWAYS review/follow the instructions accompanying the product.

X-BT-ER Stainless steel threaded stud for electrical connection

Product data

Dimensions

X-BT-ER M10/7 SN 8
X-BT-ER W10/7 SN 8

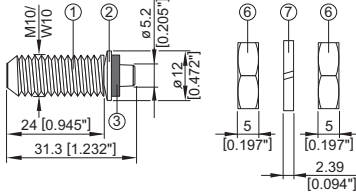

X-BT-ER M8/7 SN 8

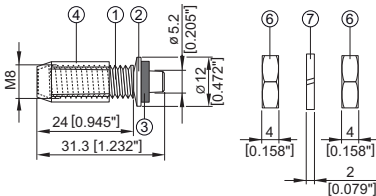

X-BT-ER M6/3 SN 8
X-BT-ER W6/3 SN 8

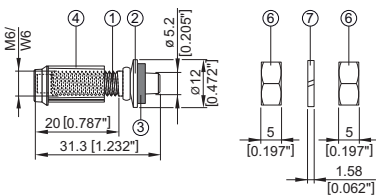

General information

Material specifications

- ① Shank:
CR 500 (CrNiMo alloy) Equivalent to A4 / AISI grade 316 material
S31803 (1.4462)
- ② Threaded sleeve: X5CrNiMo 17-12-2+2H, 1.4401
- ③ SN washer: S 31635 (X2CrNiMo 17-12-2, 1.4404)
- ④ Sealing washer: Elastomer, black *
* Resistant to UV, salt water, water, ozone, oils, etc.
- ⑤ Nuts A4 / AISI grade 316 material
- ⑥ Lock washers A4 / AISI grade 316 material
- ⑦ Guide Sleeve Plastic

Recommended fastening tools

BX 3-BT
DX 351-BT

See **X-BT fastener program** in the next pages and **Tools and equipment** chapter for more details.

Approvals for X-BT-ER stainless steel threaded studs for electrical connections

ABS 18-HS175518, DNV-GL TAS00001 SV,
BV 54554, LR 19/0003, UL-file E257067



Applications

Examples

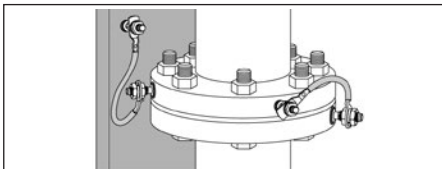

Functional and protective bonding in pipe
(Outer diameter of installed surface ≥ 150 mm)

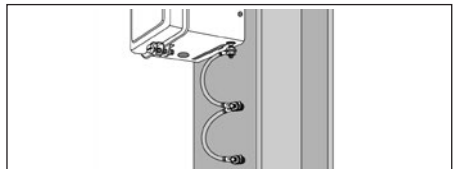

Protective bonding circuit - Double point connection

Functional bonding and terminal connection in a circuit

For low permanent current due to static charge built up in pipes or for low permanent current when closing an electrical circuit

Single point connection

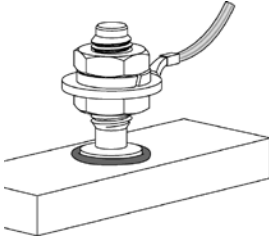

Recommended electrical connectors:

X-BT-ER M10/7 SN 8

X-BT-ER W10/7 SN 8

X-BT-ER M8/7 SN 8

X-BT-ER M6/3 SN 8, X-BT-ER M6/7 SN 8

X-BT-ER W6/3 SN 8, X-BT-ER W6/7 SN 8

Maximum allowable permanent current = 40 A

Note:

- Recommended connected cable size (tested to 40 A) according to IEC/EN 60204-1: $\leq 10 \text{ mm}^2$ copper ($\leq 8 \text{ AWG}$). Fastening of thicker cable is acceptable provided the maximum permanent current of 40 A is not exceeded and the provisions on cable lug thickness are observed.

Protective bonding circuit

For discharging short circuit current while protecting electrical equipment or earth / ground or bonded cable trays and ladders

Single point connection

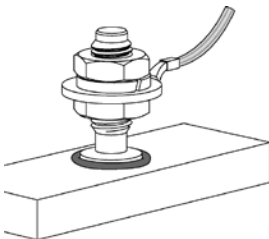

Recommended electrical connectors:

X-BT-ER M10/7 SN 8

X-BT-ER W10/7 SN 8

X-BT-ER M8/7 SN 8

X-BT-ER M6/3 SN 8, X-BT-ER M6/7 SN 8

X-BT-ER W6/3 SN 8, X-BT-ER W6/7 SN 8

Max. short circuit current for period of 1 s = 1250 A

Note:

- Recommended connected cable size (tested to 1250 A for 1 s) following IEC/EN 60947-7-2: $\leq 10 \text{ mm}^2$ copper ($\leq 8 \text{ AWG}$). Fastening of thicker cable is acceptable provided the maximum current of 1250 A for a period of 1 second is not exceeded and the provisions on cable lug thickness are observed.
- Recommended connected cable size (tested to 750 A for 4 s) according to UL 467: $\leq 10 \text{ AWG}$

Double point connection

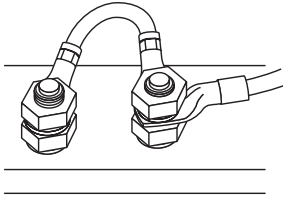

Recommended electrical connectors:

- X-BT-ER M10/7 SN 8**
- X-BT-ER W10/7 SN 8**
- X-BT-ER M8/7 SN 8**
- X-BT-ER M6/7 SN 8**
- X-BT-ER W6/7 SN 8**

Max. short circuit current for period of 1 s = 1800 A

Note:

- Recommended connected cable size (tested to 1800 A for 1 s) following IEC/EN 60947-7-2: $\leq 16 \text{ mm}^2$ copper ($\leq 6 \text{ AWG}$). Fastening of thicker cable is acceptable provided the maximum current of 1800 A for a period of 1 second is not exceeded and the provisions on cable lug thickness are observed.

Lightning protection

For high temporary current due to lightning.

Single point connection

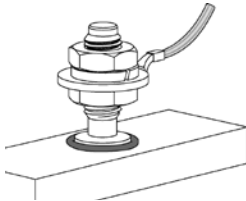

Recommended electrical connectors:

- X-BT-ER M10/7 SN 8**
- X-BT-ER W10/7 SN 8**
- X-BT-ER M8/7 SN 8**
- X-BT-ER M6/3 SN 8, X-BT-ER M6/7 SN 8**
- X-BT-ER W6/3 SN 8, X-BT-ER W6/7 SN 8**

Maximum test current (according to EN 62561-1):
 $\leq 50 \text{ kA}$ for 2 ms

When one nut is utilized and cable lug is in contact with base material.

- Cable lug must be in direct contact with non-coated base material.
- Extra M10/W10 stainless steel washer to be used and installed between lock washer and cable lug.
- Base material must not contact the X-BT-ER SN washer, lock washer and nut.
- Cable lug thickness = 2 mm to 12 mm. Cable lug hole diameter $\geq 14 \text{ mm}$.
- **Max. tightening torque = 20 Nm.**

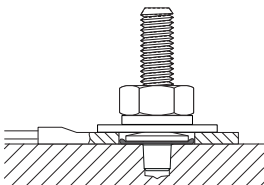

Recommended electrical connectors:

- X-BT-ER M10/7 SN 8**
- X-BT-ER W10/7 SN 8**
- X-BT-ER M8/7 SN 8**
- X-BT-ER M6/3 SN 8, X-BT-ER M6/7 SN 8**
- X-BT-ER W6/3 SN 8, X-BT-ER W6/7 SN 8**

Maximum test current:
 $\leq 100 \text{ kA}$ for 2 ms

Application requirements

Thickness of base material

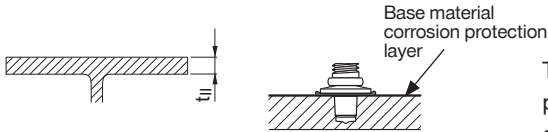

Thickness of base material corrosion protection layer ≤ 0.4 mm. For thicker coatings, please contact Hilti.

Thickness of cable lug

X-BT-ER M8/M10/W10
X-BT-ER M6/W6 /7 SN 8

$t_{cl} \leq 7$ mm (0.28")

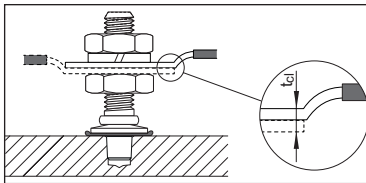

X-BT-ER M6/W6 /3 SN 8

$t_{cl} \leq 3$ mm (0.12")

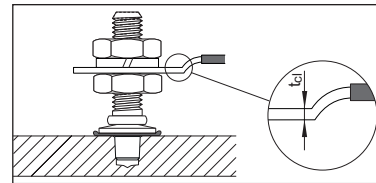

Spacing and edge distances

Edge distance:

$c \geq 6$ mm

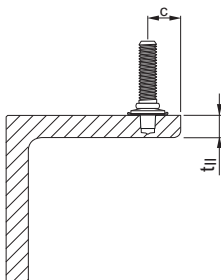

Spacing:

$s \geq 15$ mm

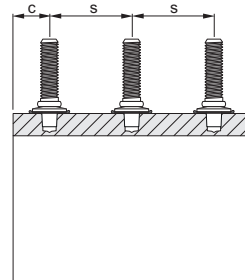

Corrosion information

The corrosion resistance of Hilti CR500 and S31803 stainless steel material is equivalent to AISI 316 (A4) steel grade.

Application limit

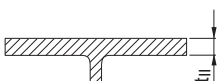

- $t_{II} \geq 8$ mm [5/16"] no through penetration
- $t_{II} \geq 6$ mm for through penetration
- No limits with regards to steel strength

Fastener selection and system recommendation BX 3-BT

Fastener program

Designation	Item no.	Tool designation	Fastener Guide designation
X-BT-ER M10/7 SN 8	2194352	BX 3-BT	X-FG B3-BT M
X-BT-ER M8/7 SN 8	2194351	BX 3-BT	X-FG B3-BT M
X-BT-ER M6/3 SN 8	2252195	BX 3-BT	X-FG B3-BT M
X-BT-ER W10/7 SN 8	2194353	BX 3-BT	X-FG B3-BT W
X-BT-ER W6/3 SN 8	2252198	BX 3-BT	X-FG B3-BT W

Fastener selection and system recommendation DX 351-BT

Fastener program

Designation	Item no.	Tool designation	Fastener Guide designation
X-BT-ER M10/7 SN 8	2194352	DX 351-BT	BT FG M1024
X-BT-ER M8/7 SN 8	2194351	DX 351-BT	BT FG M1024
X-BT-ER M6/3 SN 8	2252195	DX 351-BT	BT FG M1024
X-BT-ER M6/7 SN 8	2194349	DX 351-BT	BT FG M1024
X-BT-ER W10/7 SN 8	2194353	DX 351-BT	BT FG W1024
X-BT-ER W6/3 SN 8	2252198	DX 351-BT	BT FG W1024
X-BT-ER W6/7 SN 8	2194350	DX 351-BT	BT FG W1024

Cartridge selection and tool energy setting

6.8/11 M high precision brown cartridge

Fine adjustment by installation tests on site

Fastening quality assurance

Fastening inspection

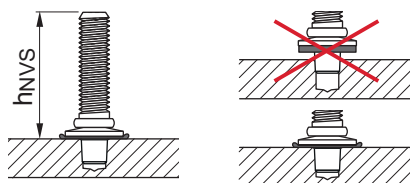

X-BT-ER M/W10, X-BT-ER M8 and X-BT-ER M/W6

$h_{NVS} = 25.7 - 26.8 \text{ mm}$
 $= 1.01'' - 1.055''$

Installation for electrical connections

Single point connection for all X-BT-ER

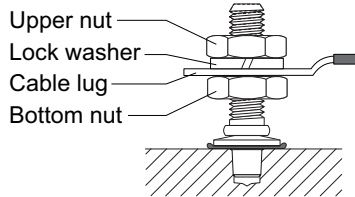
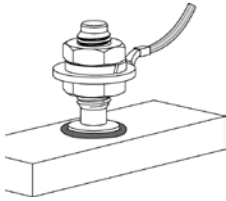

Double point connection only for X-BT-ER M6/W6 and X-BT-ER M8

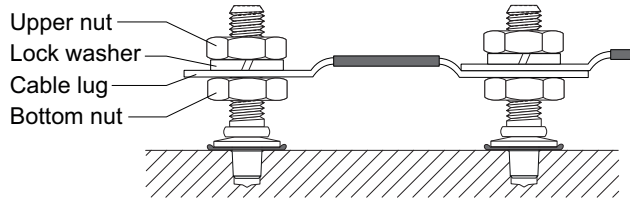
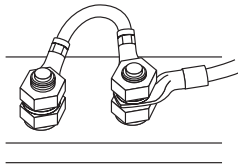

Torque recommendation for X-BT-ER

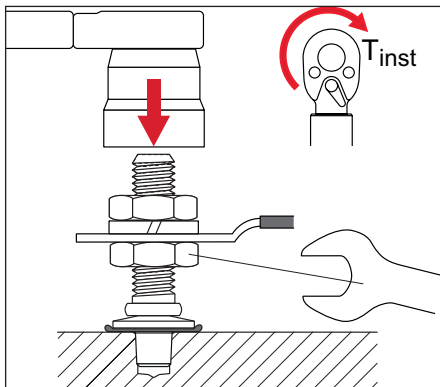

Hold the bottom nut with a spanner while tightening the upper nut.

Tightening torque:

$$T_{inst} = 8 - 20 \text{ Nm}$$

These are abbreviated instructions which may vary by application.

ALWAYS review/follow the instructions accompanying the product.

S-BT-ER, S-BT-EF Screw-in stainless steel and carbon steel threaded stud

Product data

Dimensions

S-BT-ER M10/15 SN 6
 S-BT-ER W10/15 SN 6
 S-BT-EF M10/15 AN 6
 S-BT-EF W10/15 AN 6

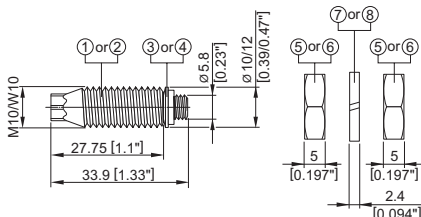

S-BT-ER M8/15 SN 6
 S-BT-EF M8/15 AN 6

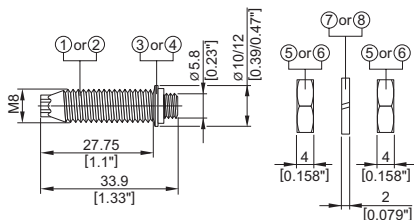

S-BT-ER M10 HC 35*)
 S-BT-ER W10 HC AWG2*)
 S-BT-ER M10 HC 120
 S-BT-ER W10 HC AWG4/0
 S-BT-EF M10 HC 35*)
 S-BT-EF W10 HC AWG2*)
 S-BT-EF M10 HC 120
 S-BT-EF W10 HC AWG4/0

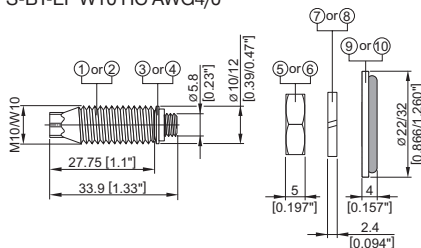

General information

Material specifications

- ① Threaded shank: Stainless steel (S-BT-ER)
"S 31803 (1.4462)"
zinc-coated
- ② Threaded shank: Carbon steel (S-BT-EF)
"1038 / duplex-coated"
- ③ SN12-R washers: Stainless steel (S-BT-ER)
"S 31603 (1.4404)"
- ④ AN10-F washers: Aluminum (S-BT-EF)
Stainless steel (S-BT-ER)
grade A4 / AISI 316 material
- ⑤ Nut: Carbon steel (S-BT-EF)
HDG
- ⑥ Nut: Stainless steel (S-BT-ER)
grade A4 / AISI 316 material
- ⑦ Lock washer: Carbon steel (S-BT-EF)
HDG
- ⑧ Lock washer: Stainless steel (S-BT-ER)
grade A4 / AISI 316 material
- ⑨ Conductivity disc: HDG
Ø 22 mm [0.866"]
(HC 35/AWG2)
Copper alloy CuSn8
(tin-coated) with sealing ring
- ⑩ Conductivity disc: HDG
Ø 32 mm [1.260"]
(HC 120/AWG4/0)
Copper alloy CuSn8
(tin-coated) with sealing ring

Sealing ring of sealing washers: Chloroprene rubber CR 3.1107, black, resistant to UV, salt water, water, ozone, oils etc.

Conductivity discs: FKM, Resistant to UV, salt water, water, ozone, oils, etc.

Drilling tool, setting tool, accessories and

inserts

Refer to section "Fastener selection and system recommendation" for more details.

Reports and type approvals



*) this items are available only on special request

Applications

Examples

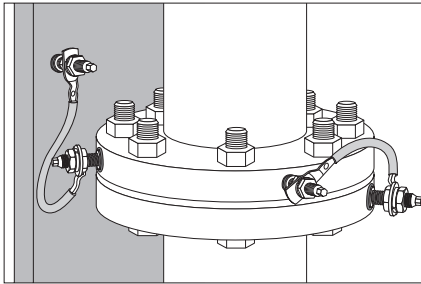

Functional and protective bonding of pipes *)
(outer diameter of installed surface ≥ 150 mm)

*) only for Type A cable connections

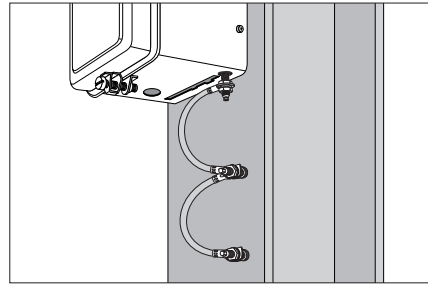

Protective bonding circuit – Double point connection

Functional bonding and terminal connection in a circuit

For permanent current (leakage current) due to static charge built up in pipes or when closing an electrical circuit.

Single point connection

Type A

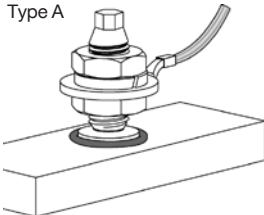

Recommended electrical connectors:

S-BT-ER M10/15 SN 6
S-BT-ER W10/15 SN 6
S-BT-EF M10/15 AN 6
S-BT-EF W10/15 AN 6
S-BT-ER M8/15 SN 6
S-BT-EF M8/15 AN 6

Maximum allowable permanent current

$I_{th} = 57$ A

Type B

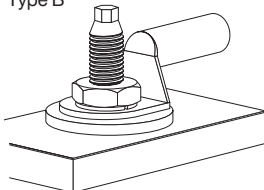

S-BT-ER M10 HC 35*)
S-BT-ER W10 HC AWG2*)
S-BT-EF M10 HC 35*)
S-BT-EF W10 HC AWG2*)

$I_{th} = 125$ A

S-BT-ER M10 HC 120
S-BT-ER W10 HC AWG4/0
S-BT-EF M10 HC 120
S-BT-EF W10 HC AWG4/0

$I_{th} = 269$ A

Note:

- Recommended maximal cross section of connected cable according **IEC 60947-7-2 and IEC 60947-7-1**:
 10 mm² (8 AWG) copper (tested permanent current $I_{th} = 57$ A)
 35 mm² (2 AWG) copper (tested permanent current $I_{th} = 125$ A)
 120 mm² (4/0 AWG) copper (tested permanent current $I_{th} = 269$ A)
- Fastening of thicker cable is acceptable, if the maximum allowable permanent current I_{th} is not exceeded and the provisions on cable lug thickness t_{cl} are observed.

*) this items are available only on special request

Protective bonding circuit

For discharging short circuit current while protecting electrical equipment or earth / ground cable trays and ladders.

Single point connection

Type A

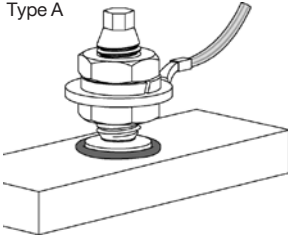

Recommended electrical connectors:

S-BT-ER M10/15 SN 6
 S-BT-ER W10/15 SN 6
 S-BT-EF M10/15 AN 6
 S-BT-EF W10/15 AN 6
 S-BT-ER M8/15 SN 6
 S-BT-EF M8/15 AN 6

Max. short circuit current according to IEC and UL

$I_{CW} = 1.20 \text{ kA (IEC)}$
 $I_{CW} = 0.75 \text{ kA (UL)}$

Type B

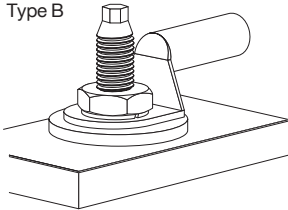

S-BT-ER M10 HC 35*)
 S-BT-ER W10 HC AWG2*)
 S-BT-EF M10 HC 35*)
 S-BT-EF W10 HC AWG2*)

$I_{CW} = 4.20 \text{ kA (IEC)}$
 $I_{CW} = 3.90 \text{ kA (UL)}$

S-BT-ER M10 HC 120
 S-BT-ER W10 HC AWG4/0
 S-BT-EF M10 HC 120
 S-BT-EF W10 HC AWG4/0

$I_{CW} = 14.40 \text{ kA (IEC)}$
 $I_{CW} = 10.10 \text{ kA (UL)}$

Note:

- Recommended maximal cross section of connected cable according **IEC 60947-7-2 and IEC 60947-7-1**:
 10 mm² (8 AWG) copper (tested short circuit current $I_{CW} = 1.20 \text{ kA}$ for 1 s)
 35 mm² (2 AWG) copper (tested short circuit current $I_{CW} = 4.20 \text{ kA}$ for 1 s)
 120 mm² (4/0 AWG) copper (tested short circuit current $I_{CW} = 14.40 \text{ kA}$ for 1 s)
 according **UL 467**:
 10 AWG copper (tested short circuit current $I_{CW} = 0.75 \text{ kA}$ for 4 s)
 2 AWG copper (tested short circuit current $I_{CW} = 3.90 \text{ kA}$ for 6 s)
 4/0 AWG copper (tested short circuit current $I_{CW} = 10.10 \text{ kA}$ for 9 s)
- Fastening of thicker cable is acceptable, if the maximum short circuit current I_{CW} and the exposure time is not exceeded and the provisions on cable lug thickness t_{cl} are observed.

Double point connection

Type A

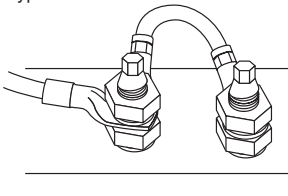

Recommended electrical connectors:

S-BT-ER M10/15 SN 6
 S-BT-ER W10/15 SN 6
 S-BT-EF M10/15 AN 6
 S-BT-EF W10/15 AN 6
 S-BT-ER M8/15 SN 6
 S-BT-EF M8/15 AN 6

Max. short circuit current according to IEC

$I_{CW} = 1.92 \text{ kA (IEC)}$

*) this items are available only on special request

Note:

- Recommended maximal cross section of connected cable according **IEC 60947-7-2 and IEC 60947-7-1**:
16 mm² (6 AWG) copper (tested short circuit current $I_{CW} = 1.92$ kA for 1 s)
- Fastening of thicker cable is acceptable, if the maximum short circuit current I_{CW} and the exposure time is not exceeded and the provisions on cable lug thickness t_{Cl} are observed.

Lightning protection

For high temporary current due to lightning.

Single point connection
Classification N

(acc. IEC 62561-1)

Type A



Recommended electrical connectors:

S-BT-ER M10/15 SN 6
S-BT-ER W10/15 SN 6
S-BT-EF M10/15 AN 6
S-BT-EF W10/15 AN 6
S-BT-ER M8/15 SN 6
S-BT-EF M8/15 AN 6

Maximum lightning current

$I_{imp} = 50$ kA for ≤ 5 ms
 (according to IEC 62561-1)

Type B

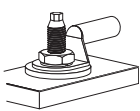

S-BT-ER M10 HC 35*)
S-BT-ER W10 HC AWG2*)
S-BT-EF M10 HC 35*)
S-BT-EF W10 HC AWG2*)
S-BT-ER M10 HC 120
S-BT-ER W10 HC AWG4/0
S-BT-EF M10 HC 120
S-BT-EF W10 HC AWG4/0

Classification H

(acc. IEC 62561-1)

Type B

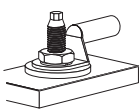

Recommended electrical connectors:

S-BT-ER M10 HC 35*)
S-BT-ER W10 HC AWG2*)
S-BT-EF M10 HC 35*)
S-BT-EF W10 HC AWG2*)
S-BT-ER M10 HC 120
S-BT-ER W10 HC AWG4/0
S-BT-EF M10 HC 120
S-BT-EF W10 HC AWG4/0

$I_{imp} = 100$ kA for ≤ 5 ms
 (according to IEC 62561-1)

*) this items are available only on special request

When S-BT-ER / -EF is used in class H applications only type B cable connection is allowed.

Tightening torque of 8 Nm must be observed accurately for type B cable connection.

Application Requirements

Base material thickness $t_{II} \geq 6$ mm

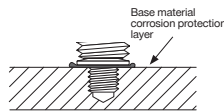
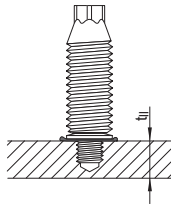

Thickness of base material corrosion protection layer ≤ 0.8 mm [0.0315"].

For single point connection type B conductivity disc must be in direct contact with non-coated base material.

Cable lug characteristics and connector types

Cable lug thickness t_{cl} and inner hole diameter d_2

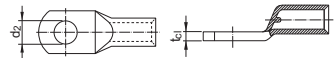

Fastener	Single point connector		Double point connector	
	Type A		Type A	
	t_{cl} [mm]	d_2 [mm]	t_{cl} [mm]	d_2 [mm]
S-BT-ER M10/15 SN 6	≤ 7	10.5	≤ 7	10.5
S-BT-ER W10/15 SN 6	≤ 7	10.5	≤ 7	10.5
S-BT-EF M10/15 AN 6	≤ 7	10.5	≤ 7	10.5
S-BT-EF W10/15 AN 6	≤ 7	10.5	≤ 7	10.5
S-BT-ER M8/15 SN 6	≤ 7	8.5	≤ 7	8.5
S-BT-EF M8/15 AN 6	≤ 7	8.5	≤ 7	8.5

Fastener	Single point connector	
	Type B	
	t_{c1} [mm]	d_2 [mm]
S-BT-ER M10 HC 35*)	≤ 12	10.5
S-BT-ER W10 HC AWG2*)	≤ 12	10.5
S-BT-EF M10 HC 35*)	≤ 12	10.5
S-BT-EF W10 HC AWG2*)	≤ 12	10.5
S-BT-ER M10 HC 120	≤ 12	10.5
S-BT-ER W10 HC AWG4/0	≤ 12	10.5
S-BT-EF M10 HC 120	≤ 12	10.5
S-BT-EF W10 HC AWG4/0	≤ 12	10.5

Single point connector		Double point connector
Type A	Type B	Type A

*) this items are available only on special request

Spacing & edge distances

Edge distance:

Type A connector: ≥ 6 mm [0.236"]

Type B connector: ≥ 20 mm [0.787"]

Spacing:

Type A connector: ≥ 22 mm [0.866"]

Type B connector: ≥ 40 mm [1.575"]

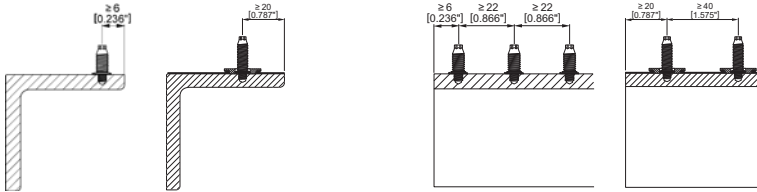

Installation temperature and service temperature

The **installation temperature** is the temperature at which the S-BT studs are installed. A distinction is made between the temperature of the base material and the temperature of the S-BT studs, drilling and installation tools and accessories. The installation temperature range can be found in the table below.

The **service temperature** is the temperature at which the S-BT studs operate. The S-BT studs will operate effectively and without any loss in performance (loads, sealing function, etc.) within the specified service temperature range. Outside this temperature range the S-BT studs may fail.

Designation	Installation temperature		Service temperature	
	min	max	min	max
Base material	-40 °C	+60 °C	-40 °C	+100 °C
S-BT studs	-10 °C	+60 °C	-40 °C	+100 °C
Drilling & Installation tools and accessories	-10 °C	+60 °C	n.a.	n.a.

Note:

The service temperature range of the connected cable lugs and cables has to be observed. For details please contact the supplier of the cable lugs and cables. When using Hilti S-BT fasteners in combination with fire rated boundaries in Shipbuilding facilities, the max. service temperature for a period of 60 minutes is higher. For more details refer to section 5.10 "Fire resistance" in the S-BT Specification binder.

Corrosion information

The S-BT-ER stainless studs are made from the duplex stainless steel type 1.4462, which is equivalent to AISI 316 (A4) steel grade. This grade of stainless steel is classified in the corrosion resistance class IV according to DIN EN 1993-1-4:2015, which makes the material suitable for aggressive environments such as coastal and offshore applications.

The microstructures of duplex stainless steels consist of a mixture of austenite and ferrite phases. Compared to the austenitic stainless steel grades, duplex stainless steels are magnetic. The surface of the S-BT-ER stainless steel fasteners is zinc-coated (anti-friction coating) in order to reduce the thread forming torque when the stud is screwed in into the base material.

The coating of the carbon steel S-BT-EF fasteners consists of an electroplated Zn-alloy for cathodic protection and a top coat for chemical resistance (Duplex-coating). The thickness of the coating is 35 µm. This product is designed for use in corrosive categories C1, C2 and C3 according to the standard EN ISO 9223.

The conductivity disc of the S-BT-ER / -EF HC is made from copper alloy CuSn8 with a tin-coating on the surface and a sealing ring on the bottom side. The copper alloy is classified as largely insensitive to stress corrosion cracking and pitting corrosion. The conductivity disc is designed for use in corrosion categories C1 - C5 according to EN ISO 9223. It is therefore suitable for use in aggressive environments like coastal and offshore applications.

To prevent corrosion of the base material due to the drilling process the following base material thickness t_{II} has to be given.

	Fastener	
	Carbon steel S-BT-EF	Stainless steel S-BT-ER
Corrosivity category C Corrosion resistance class (CRC)	C1, C2, C3	CRC III, IV
Base material thickness t_{II} ¹⁾		
6 mm [0.24"] ≤ t_{II} < 7 mm [0.28"] Pilot drill may cause damage to backside coating	✓	✓ ²⁾
t_{II} ≥ 7 mm [0.28"] Pilot drill will not affect backside of base material	✓	✓

1) Real base material thickness, not nominal material thickness or material thickness with coating.

2) Damage of the coating on the back side of the plate / profile require a rework of the coating, if the drilling tools SF BT 22-A or SF BT 18-A were used for drilling the bore hole. If the tool SBT 4-A22 was used for drilling the bore hole, no damage of the coating on the back side of the plate / profile will occur.

Application limit

The base material is limited to steel grade with a maximum tensile strength $f_u = 630$ MPa [91 ksi].

The minimum tensile strength of steel is $f_u \geq 340$ MPa [49 ksi].

Minimum thickness of base material t_{II} : refer to section "Application Requirements".

Maximum thickness of base material t_{II} : no limits.

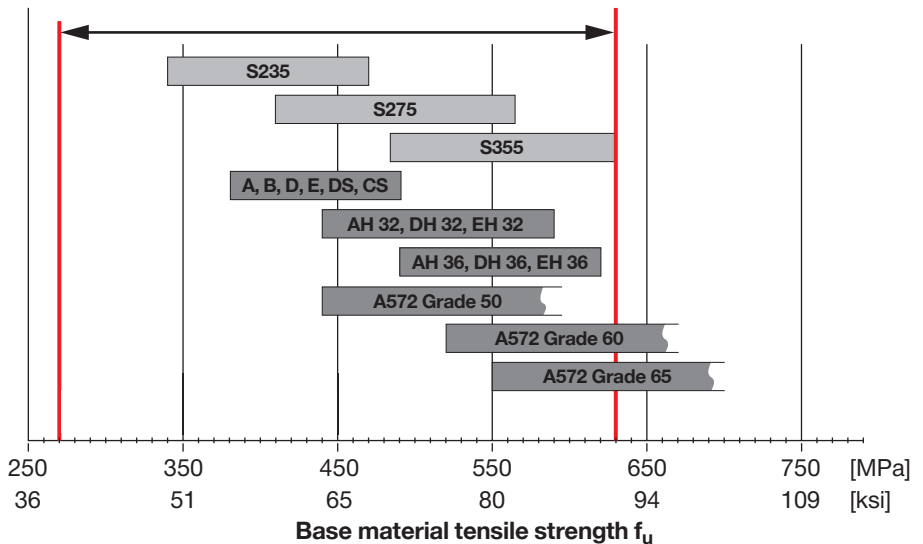

Fastener selection and system recommendation

Fasteners	Drilling tool	Setting tool	Stepped drill bit	Depth gauge
S-BT-ER M8/15 SN 6	SBT 4-A22, SF BT 18-A or SF BT 22-A	SBT 4-A22, SFC 18-A or SFC 22-A	TS-BT 5.5-74 S	S-DG BT M8/15 Long 6
S-BT-EF M8/15 AN 6				S-DG BT M10-W10/15 Long 6
S-BT-ER M10/15 SN 6				
S-BT-ER W10/15 SN 6				
S-BT-EF M10/15 AN 6				
S-BT-EF W10/15 AN 6				

Fasteners	Drilling tool	Setting tool	Stepped drill bit + coating removal drill bit	Depth gauge
S-BT-ER M10 HC 35*)	SBT 4-A22, SF BT 18-A or SF BT 22-A	SBT 4-A22, SFC 18-A or SFC 22-A	TS-BT 5.5-74 S TS-BT HC 35/AWG2	S-DG BT M10-W10 HC 6
S-BT-ER W10 HC AWG2*)				
S-BT-EF M10 HC 35*)				
S-BT-EF W10 HC AWG2*)				
S-BT-ER M10 HC 120			TS-BT 5.5-74 S TS-BT HC 120/AWG4/0	
S-BT-ER W10 HC AWG4/0				
S-BT-EF M10 HC 120				
S-BT-EF W10 HC AWG4/0				

Fastener quality assurance

In order to ensure the exact screw-in depth and a proper compressed sealing washer, the S-BT studs have to be installed with the appropriate depth gauge. With this tool the screw-in depth can be adjusted in a range of 0 - 1.5 mm (3 steps, 0.5mm per step). The S-CC BT calibration card is needed to check the initial stand-off of the S-BT stud and to adjust/calibrate the S-DG depth gauge. After finding the right adjustment level for the S-DG depth gauge, the gauge can be adjusted and the studs can be installed without additional check of the S-DG depth gauge. The depth gauge has to be re-adjusted (calibrated) at following times:

- Start of the installation process
- Change of the working position (upwards, downwards, horizontal) and base material (thickness, strength, type)
- Installer change
- After each packaging respectively after the installation of 100 S-BT studs

The lifetime of the S-DG BT depth gauge is ≥ 1000 settings.

The installer is responsible for the correct setting of the S-BT studs.

For the periodical verification of the correct stud stand-off the S-CG BT check gauge can be used.



S-DG BT mechanical depth gauge

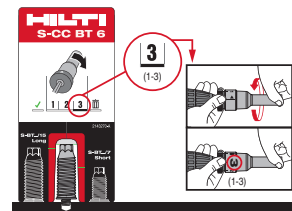

Design and functionality of the mechanical calibration card S-CC BT

*) this items are available only on special request

Fastening inspection

 Verify stud stand-off h_{NVS} with check gauge S-CG BT

 $h_{NVS} = 29.3 \text{ mm to } 29.8 \text{ mm [1.153" to 1.173"]}$

- S-BT-ER M10/15 SN 6**
- S-BT-ER W10/15 SN 6**
- S-BT-EF M10/15 AN 6**
- S-BT-EF W10/15 AN 6**
- S-BT-ER M8/15 SN 6**
- S-BT-EF M8/15 AN 6**

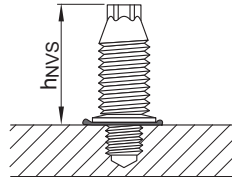

Design and functionality of the check gauge S-CG BT

 $h_{NVS} = 26.10 \text{ mm to } 26.60 \text{ mm [1.028" to 1.047"]}$

- S-BT-ER M10 HC ____**
- S-BT-ER W10 HC ____**
- S-BT-EF M10 HC ____**
- S-BT-EF W10 HC ____**

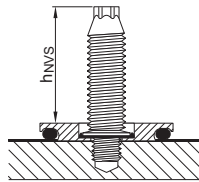

Designation	Product name	Comment
S-DG BT M8/15 Long 6	Depth gauge	for exact setting of S-BT-ER M8/15 SN 6, S-BT-EF M8/15 AN 6
S-DG BT M10-W10/15 Long 6	Depth gauge	for exact setting of S-BT-ER M10/15 SN 6, S-BT-ER W10/15 SN 6, S-BT-EF M10/15 AN 6, S-BT-EF W10/15 AN 6
S-DG BT M10-W10 HC 6	Depth gauge	for exact setting of S-BT-ER M10 HC ____, S-BT-ER W10 HC ____, S-BT-EF M10 HC ____, S-BT-EF W10 HC ____
S-CC BT 6	Calibration card	for calibration of the depth gauge for S-BT-ER and S-BT-EF
S-CC BT HC 6	Calibration card	for calibration of the depth gauge for S-BT-ER M10 HC ____, S-BT-ER W10 HC ____, S-BT-EF M10 HC ____, S-BT-EF W10 HC ____
S-CG BT /15 Long 6	Check gauge	for verification of the stand-off for S-BT-ER and S-BT-EF
S-CG BT HC	Check gauge	for verification of the stand-off for S-BT-ER M10 HC ____, S-BT-ER W10 HC ____, S-BT-EF M10 HC ____, S-BT-EF W10 HC ____

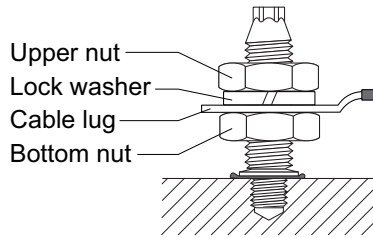
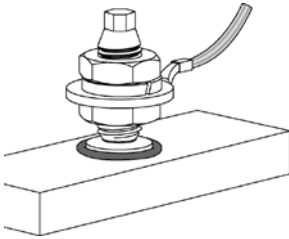
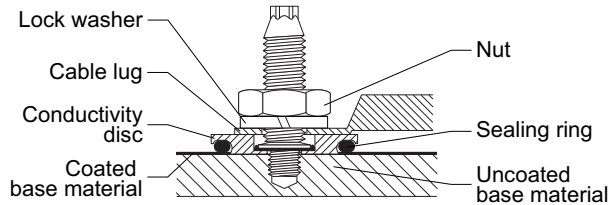
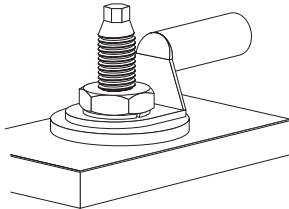
Installation
Single point connection
Single point connection type A:

Single point connection type B:

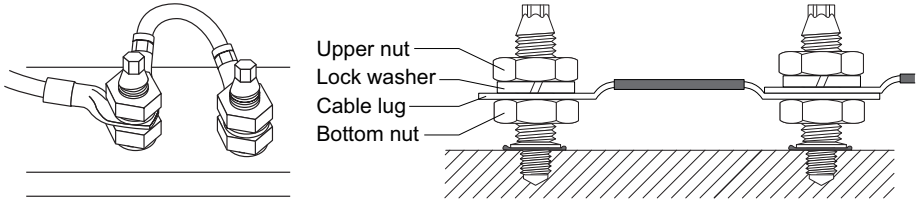
For Type B cable connection the following requirements have to be observed:

- The conductivity disc must be in direct contact with the non-coated base material.
Coating has to be removed with the coating removal drill bit.
- **Tightening torque of 8 Nm** must be observed accurately.

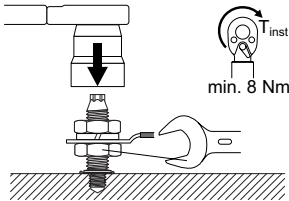
Double point connection
Double point connection type A:

Torque recommendation for all S-BT-ER and S-BT-EF
Single point connection type A and double point connection type A:

Hold the bottom nut with a spanner while tightening the upper nut.

 T_{inst}
min. 8 Nm

Tightening Torque:

Min. 8 Nm

Max. 20 Nm

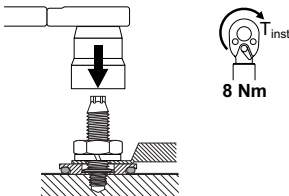
Single point connection type B:

 T_{inst}
8 Nm

The tightening torque is **8 Nm**. Exceeding or falling below this tightening torque value is not allowed. Tighten the nut using torque tool X-BT 1/4" (8 Nm), torque wrench or Hilti screw driver SBT 4-A22, SFC 18-A, SFC 22-A (torque setting 5) with socket S-NS.

Important: These are abbreviated instructions which may vary by application. ALWAYS review / follow the instructions for use (IFU) accompanying the product

Fastener program

Designation	Item no.	Product name	Comment	Application
S-BT-EF M8/15 AN 6	2186208	Threaded stud	package includes nuts and lock washers	Electrical connection
S-BT-EF M10/15 AN 6	2186204	Threaded stud		
S-BT-EF W10/15 AN 6	2186206	Threaded stud		
S-BT-ER M8/15 SN 6	2186207	Threaded stud	package includes nuts and lock washers	Electrical connection
S-BT-ER M10/15 SN 6	2186203	Threaded stud		
S-BT-ER W10/15 SN 6	2186205	Threaded stud		
S-BT-ER M10 HC 35*)	2204737	Threaded stud	package includes nuts, lock washers and conductor discs	Electrical connection
S-BT-ER W10 HC AWG2*)	2204738	Threaded stud		
S-BT-ER M10 HC 120	2204739	Threaded stud		
S-BT-ER W10 HC AWG4/0	2206611	Threaded stud		
S-BT-EF M10 HC 35*)	2204930	Threaded stud	package includes nuts, lock washers and conductor discs	Electrical connection
S-BT-EF W10 HC AWG2*)	2204931	Threaded stud		
S-BT-EF M10 HC 120	2204932	Threaded stud		
S-BT-EF W10 HC AWG4/0	2206612	Threaded stud		
TS-BT 5.5-74 S	2143137	Stepped drill bit	for base material steel	
TS-BT HC 35/AWG2	2204935	Coating removal drill bit	for removal of the coating from the base material	
TS-BT HC 120/AWG4/0	2204736	Coating removal drill bit	for removal of the coating from the base material	
S-DG BT M10-W10/15 Long 6	2143261	Depth gauge	for exact setting of the S-BT	
S-DG BT M8/15 Long 6	2148575	Depth gauge	for exact setting of the S-BT	
S-DG BT M10-W10/15 HC 6	2204933	Depth gauge	for exact setting of the S-BT ____ HC ____	
S-CC BT 6	2143270	Calibration card	for calibration of the depth gauge	
S-CC BT HC 6	2204934	Calibration card	for calibration of the depth gauge	

*) this items are available only on special request

X-FCM Grating fastening system

Product data

Dimensions

X-FCM

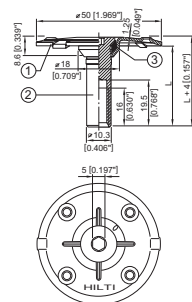

X-FCM-M_L

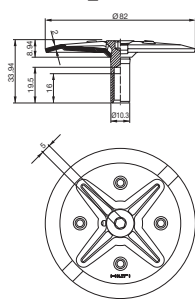

General information

Material specifications

See fastener selection for more details.

Recommended fastening tools

See **X-FCM fastener program** in the next pages and **Tools and equipment** chapter for more details.

Approvals

DNV GL, BV: X-FCM-M, X-FCM-R

ABS, LR: all types

No approvals for X-FCM-M_L

X-ST-GR M8/10 P8

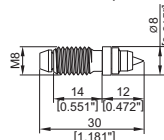

X-CRM8-15-12 FP10

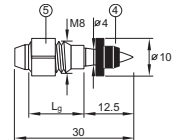

X-CRM8-15-12 P8

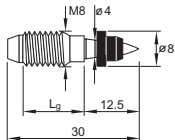

X-EM8H-15-12 FP10

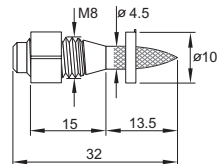

X-BT M8-15-6 SN12-R

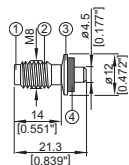

X-BT-GR M8/7 SN8

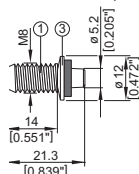

S-BT-GF M8/7 AN 6
S-BT-GR M8/7 SN 6
S-BT-GR M8/7 SN 6 AL

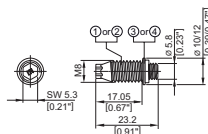

X-EM8H-15-12 P8

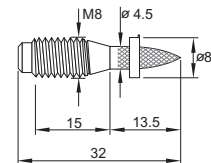

Applications

Example

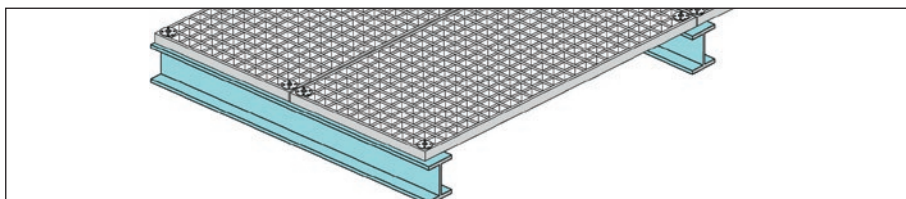

Grating (steel and fiberglass reinforced)

Load data

Recommended tensile loads N_{rec} [kN]

Grating opening type

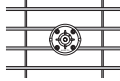
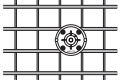
	Rectangular		Square	
				
	Bar spacing [mm]		Bar spacing [mm]	
	18	30	18	30
X-FCM	0.8 ²⁾	0.8 ²⁾	2.4 ¹⁾³⁾	0.8 ²⁾
X-FCM-M	0.8 ²⁾	0.8 ²⁾	1.8 ¹⁾³⁾	0.8 ²⁾
X-FCM-R	1.4 ²⁾³⁾	1.0 ²⁾	1.8 ¹⁾³⁾	1.0 ²⁾

Grating opening type

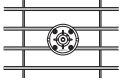
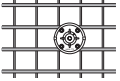
	Rectangular		Square	
				
	Bar spacing [mm]		Bar spacing [mm]	
	30	57	30	60
X-FCM-M_L	0.8 ²⁾	0.8 ²⁾	1.8 ¹⁾³⁾	0.8 ²⁾

- 1) Loading is limited by recommended load for threaded stud.
- 2) Loading is limited by elastic limit of the **X-FCM** disk. Exceeding recommended loads can result in plastic deformation of disk.
- 3) $N_{rec} = 1.0$ kN
 For S-BT-GR M8/7 SN 6 AL in aluminum base material.
 For S-BT-GR M8/7 SN 6 and S-BT-GF M8/7 AN 6 in steel base material $3 \text{ mm} \leq t_{II} < 5 \text{ mm}$ (drill through hole)
 $N_{rec} = 1.8$ kN
 For S-BT-GR M8/7 SN 6 and S-BT-GF M8/7 AN 6 in steel base material $t_{II} \geq 5 \text{ mm}$.

Notes:

X-FCM, X-FCM-M, X-FCM-R, X-FCM-M_L resist shear by friction and are not suitable for explicit shear load designs, e.g. diaphragms. Depending on surface characteristics, shear loads of up to about 0.3 kN will not result in permanent deformation. Therefore small unexpected shear loads can generally be accommodated without damage.

Characteristic tensile loads N_{Rk} :

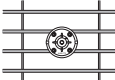
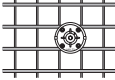
Type	Grating – bar spacing	X-FCM-R with		X-CRM / X-ST-GR
		X-BT (X-BT-GR M8/7 SN 6 for $t_{II} \geq 6 \text{ mm}$) S235 / A36 steel	S355 / Grade 50 steel	
	Rectangle 18 mm	4.2 kN / 945 lb*	4.2 kN / 945 lb*	4.2 kN / 945 lb*
	Rectangle 30 mm	3.0 kN / 675 lb*	3.0 kN / 675 lb*	3.0 kN / 675 lb*
	Square 18 mm	5.4 kN / 1215 lb	6.9 kN / 1550 lb	5.4 kN / 1215 lb
	Square 30 mm	3.0 kN / 675 lb*	3.0 kN / 675 lb*	3.0 kN / 675 lb*

* Loading is limited by elastic limit of the **X-FCM-R** disc.

Characteristic tensile loads N_{Rk} :

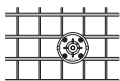
		X-FCM-R with		
		S-BT-GR M8/7 SN 6, pilot hole, $t_{H1} \geq 6$ mm		
Type	Grating – bar spacing	S235 / A36 steel	S355 / Grade 50 steel	Aluminum $R_m \geq 270$ N/mm ²
	Rectangle 18 mm	4.2 kN / 945 lb*	4.2 kN / 945 lb*	3.0 kN / 675 lb
	Rectangle 30 mm	3.0 kN / 675 lb*	3.0 kN / 675 lb*	3.0 kN / 675 lb
	Square 18 mm	5.4 kN / 1215 lb	6.9 kN / 1550 lb	3.0 kN / 675 lb
	Square 30 mm	3.0 kN / 675 lb*	3.0 kN / 675 lb*	3.0 kN / 675 lb

* Loading is limited by elastic limit of the X-FCM-R disc.

Load displacement behaviour – examples:

Tensile load

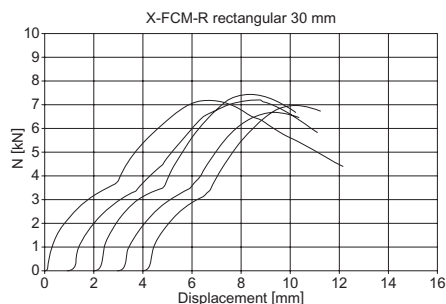

Shear load

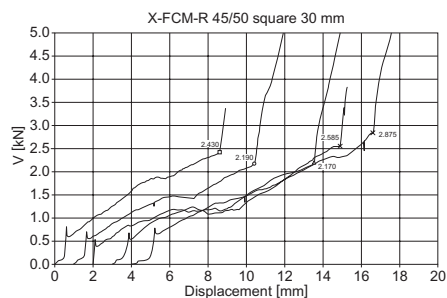

Application requirements

Thickness of base material

X-BT

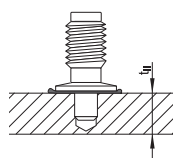

$t_{H1} \geq 8$ mm

S-BT-GF M8/7 AN 6
S-BT-GR M8/7 SN 6
S-BT-GR M8/7 SN 6 AL*)

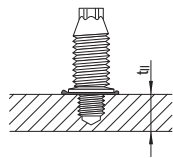

$t_{H1} \geq 6$ mm
pilot hole

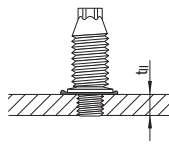

steel: 3 mm $\leq t_{H1} < 6$ mm, aluminum: 5 mm $\leq t_{H1} < 6$ mm
drill through hole

X-ST-GR,
X-CRM and
X-EM8H

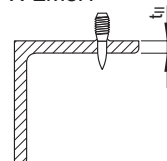

$t_{H1} \geq 6$ mm

*) for use in aluminum base material

Thickness of fastened material

Grating height: 25–50 mm with standard X-FCM. For other dimensions special X-FCM are available on demand.

Spacing and edge distances

X-ST-GR, X-CRM, X-EM8H

Edge distances: $c \geq 15 \text{ mm}$

Spacing: $s \geq 15 \text{ mm}$

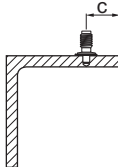

X-BT, S-BT

Edge distance: $c \geq 6 \text{ mm}$

Spacing: $s \geq 15 \text{ mm}$

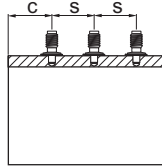

Corrosion information

For coastal and offshore applications, X-BT or S-BT-GR stainless steel fasteners have to be used, see fastener selection.

The coating of the carbon steel S-BT fasteners consists of an electroplated Zn-alloy for cathodic protection and a top coat for chemical resistance (Duplex-coating). The thickness of the coating is 35 μm . The use of this coating is limited to the corrosion category C1, C2 and C3 according the standard EN ISO 9223. For higher corrosion categories stainless steel fasteners should be used. In case of a **drill through hole**, rework of the coating on the back side of the plate / profile may be needed.

The intended use of the X-ST-GR and X-CRM fasteners comprises fastenings exposed to outdoor environments in mildly corrosive conditions where HDG coated parts are commonly specified or used. Not for use in atmospheres with chlorides (marine atmospheres) or in heavily polluted environments (e.g. sulphur dioxide).

The intended use of the X-EM8H carbon steel fasteners only comprises fastenings which are not directly exposed to external weather conditions or moist atmospheres.

Application limits

DX 460, DX 5

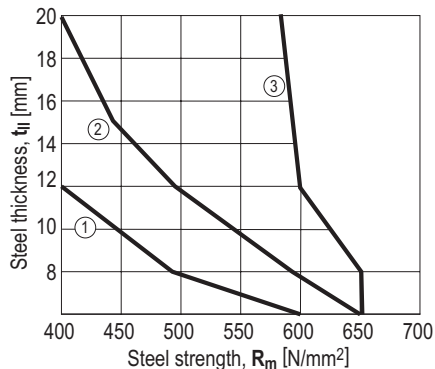

- ① X-CRM8-15-12 P8 / DX 460, DX 5 (impact)
- ② X-CRM8-15-12 P8 / DX 460, DX 5 (co-acting)
- ③ X-EM8H-15-12 P8 / DX 460, DX 5 (impact)

DX 76, DX 76 PTR

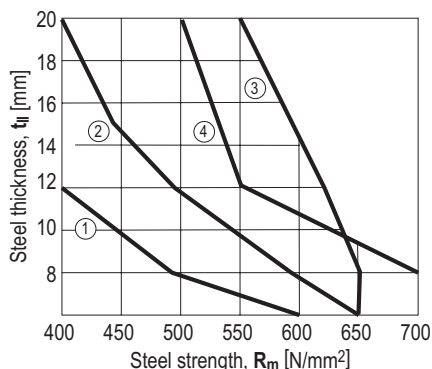

- ① X-CRM8-15-12 FP10 / DX 76, DX 76 PTR (impact)
- ② X-CRM8-15-12 FP10 / DX 76, DX 76 PTR (co-acting)
- ③ X-EM8H-15-12 FP10 / DX 76, DX 76 PTR (impact)
- ④ X-EM8H-15-12 P8 / DX 76, DX 76 PTR (impact)

X-ST-GR:

DX 460, DX 5

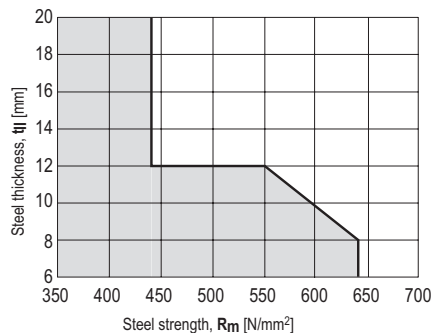

DX 76 PTR

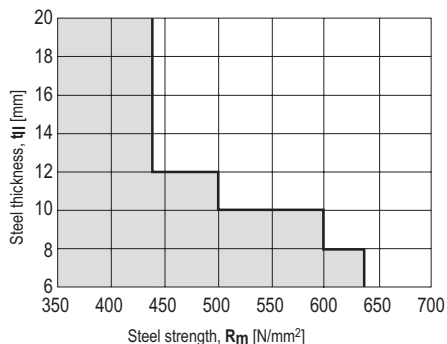

X-BT: No application limits → using in high strength steel (f_u up to 1000 MPa)

No through penetration → $t_{II} \geq 8 \text{ mm}$ [$\frac{5}{16}$ "]

S-BT:

The base material is limited to steel grade with a maximum tensile strength $f_u = 630 \text{ MPa}$ (91 ksi). The minimum tensile strength of steel is $f_u \geq 340 \text{ MPa}$ (49 ksi). The minimum tensile strength of aluminum is $f_u \geq 270 \text{ MPa}$ (39 ksi). Minimum thickness of base material t_{II} : refer to section "Thickness of base material" Maximum thickness of base material t_{II} : no limits

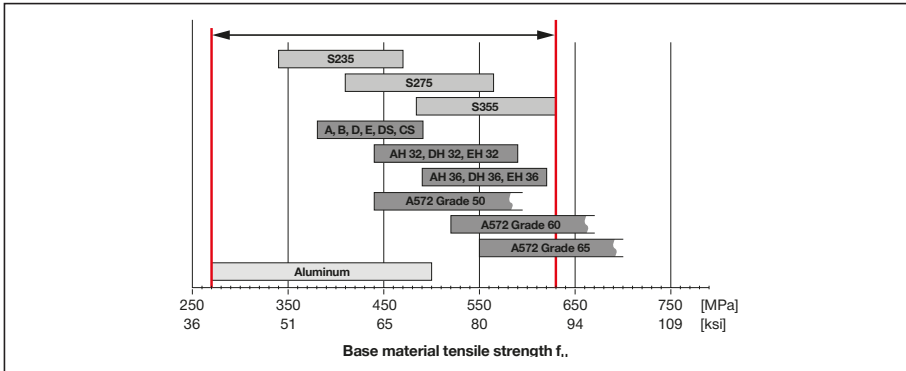

Fastener selection and system recommendation
Fastener program
Application areas

Indoors, dry and non corrosive environment

Indoors, mildly corrosive environment, or for limited lifetime use

Marine, offshore, petrochemical, caloric (coal, oil) power plants, etc.

X-FCM system

X-FCM

Zinc plated

Item no.

X-FCM-M

Duplex coated

Item no.

X-FCM-R

Stainless steel

Item no.

Dimensions
 Grating
 height
 [mm]

Tools
X-FCM 25/30

 26582
 or
 2117353

X-FCM-M 25/30

 378683
 or
 2117357

X-FCM-R 25/30 247181
 or
 2117391

23
25-30

1)

X-FCM 1"-1 1/4"

 247175
 or
 2117354

X-FCM-M 1"-1 1/4"

 378686
 or
 2117358

X-FCM-R 1"-1 1/4" 247184
 or
 2117392

27
29-34

1)

X-FCM 35/40

 26583
 or
 2117355

X-FCM-M 35/40

 378684
 or
 2117359

X-FCM-R 35/40 247182
 or
 2117393

33
35-40

1)

X-FCM 45/50

 26584
 or
 2117356

X-FCM-M 45/50

 378685
 or
 2117390

X-FCM-R 45/50 247183
 or
 2117394

43
45-50

1)

X-FCM-M 31/36 L 2042852*

 *For use with
 X-BT M8-15-6 SN12-R
 S-BT-GR M8
 S-BT-GF M8

 Note:
 Not for use in marine atmosphere or in heavily polluted environment.

 Note:
 Not for use in automobile tunnels, swimming pools or similar environments

25
31-36

1)

1) SF 100-A, SF 11-A, SF 150-A, SF 121-A, SF 14-A, SF 18-A, SFC 18-A, SF 22-A, SFC 22-A, SBT 4-A22,

Hilti Torque tool X-BT 1/4"

Threaded studs		Item no.	Tools
X-EM8H-15-12 P8		271981	²)
X-EM8H-15-12 FP10		271982	²)
	X-BT M8-15-6 SN12-R	377074	³)
	X-CR M8-15-12 P8	372033	²)
	X-CR M8-15-12 FP10	372034	²)
	S-BT-GF M8/7 AN 6	2140527	⁴), ⁵)
	S-BT-GR M8/7 SN 6	2140529	⁴), ⁵)
	S-BT-GR M8/7 SN 6 AL	2140742	⁴), ⁵)
	X-ST-GR M8/10 P8	2122460	²)

²) DX 76 PTR, DX 460, DX 5

⁴) SF BT 18-A, SF BT 22-A and SBT 4-A22 for drilling the hole

³) BX 3-BTG, DX 351-BTG

⁵) SFC 18-A, SFC 22-A and SBT 4-A22 for screw-in the fastener

Cartridge selection and tool energy setting

- X-BT:** 6.8/11M high precision brown cartridges
- X-CRM:** 6.8/11M yellow or red cartridges with DX 460, DX 5
6.8/18M blue cartridges with DX 76 and DX 76 PTR
- X-ST-GR:** 6.8/11M black or red cartridges with DX 460, DX 5
6.8/18M yellow or red cartridges with DX 76 PTR
- X-EM8H:** 6.8/11M red or black cartridges with DX 460, DX 5
6.8/18M blue, red or black cartridges with DX 76 and DX 76 PTR

Tool energy adjustment by setting tests on site.

Material specifications and coatings

	X-FCM-R		X-FCM-M + X-FCM-M_L		X-FCM		All systems ³) Absorber ¹)
	① Disk	② Threaded stem	① Disk	② Threaded stem	① Disk	② Threaded stem	
Material designation	X2CrNiMo17122	X2CrNiMo17122	DC 04	11SMNPB30+C	DC 04	11SMNPB30+C	Polyurethane Black
Coating	none	none	Duplex *	Duplex *	≥ 20µm Zn	10-20 µm Zn	-

¹) resistant to: UV, saltwater ozone, oil, grease

*) comparable to 45 µm HDG steel (480 h Salt spray test per DIN 50021)

Threaded studs

	X-BT			X-ST-GR		X-EM8H
	Shank ①	Threaded sleeve ② SN12-R washer ③	Sealing ring of sealing washer ¹⁾ ④	Shank	Threaded sleeve	
Material designation	Stainless steel CR 500 (A4 / AISI316)	X2CrNiMo17132 X5CrNiMo17122+2H (A4 / AISI316)	Elastomer, black	P558 (CrMnMo alloy)	(A4 / AISI316)	Carbon steel Ck 67 MOD
Coating	none	none		none	none	5–13 µm Zn ²⁾

¹⁾ resistant to: UV, saltwater ozone, oil, grease

²⁾ Zinc applied by electroplating. Intended for corrosion protection during shipment, storage, construction and service in protected environment. It is not adequate for protection against corrosion in outside or otherwise corrosive applications

Threaded studs

	S-BT- <u>R</u>			S-BT- <u>F</u>		
	Threaded Shank ①	SN 12-R washer ③	Sealing ring of sealing washer ¹⁾ ③	Threaded Shank ②	AN 10-F washer ④	Sealing ring of sealing washer ¹⁾ ④
Material designation	Stainless steel 1.4462 (A4 / AISI316)	Stainless steel 1.4404 (A4 / AISI316)	Elastomer, black	Carbon steel 1038	Aluminum	Elastomer, black
Coating	Zinc	none	none	Duplex-coating	none	HDG

¹⁾ resistant to: UV, salt water, ozone, oil, grease

²⁾ The surface of the S-BT stainless steel fasteners is zinc plated (anti-friction coating) in order to reduce the thread forming torque when the stud is screwed in into the base material.

Fastening quality assurance

Fastening inspection

X-BT M8-15-6 SN12-R

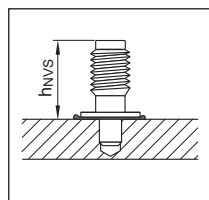

$h_{NVS} = 15.7-16.8 \text{ mm}$

X-BT-GR M8/7 SN8

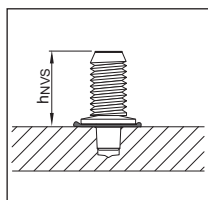

$h_{NVS} = 15.7-16.8 \text{ mm}$

X-CRM8-15-12

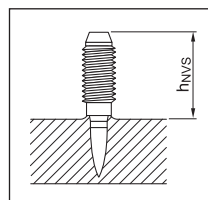

$h_{NVS} = 17-20 \text{ mm}$

X-EM8H-15-12

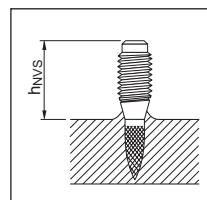

$h_{NVS} = 15.5-19.5 \text{ mm}$

X-ST-GR M8/10 P8

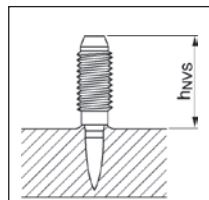

$h_{NVS} = 17.0-20.0 \text{ mm}$

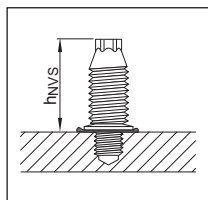

$h_{NVS} = 18.6-19.1 \text{ mm [0.732" - 0.752"]}$

S-BT-___/7___6

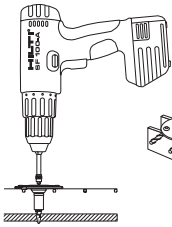

Tighten the disk



Tightening torque

$T_{rec} = \text{max. } 8 \text{ Nm}$

$T_{rec} = \text{max. } 5 \text{ Nm } ^1)$

¹⁾ For S-BT-GR M8/7 SN 6 AL in

aluminum base material

For S-BT-GR M8/7 SN 6 and

S-BT-GF M8/7 AN 6 in steel base material

$3 \text{ mm} \leq t_{II} < 5 \text{ mm}$ (drill through hole)

Tightening tool:

- Screwdriver with torque release coupling (TRC)
- 5 mm Allen-type bit
- Hilti Torque tool X-BT 1/4", which gives 8 Nm

Hilti screwdriver

	T_{rec}	
	5 Nm	8 Nm
	Torque setting	
SF 121-A	5	6
SF 150-A	4	5
SF 14	4	5
SF 14-A	5	6
SF 18-A	4	5
SFC 18-A	4	5
SF 22-A	4	5
SFC 22-A	4	5
SBT 4-A22	4	5

X-FCM-R HL Grating fastening system

Product data

Dimensions

X-FCM-R HL

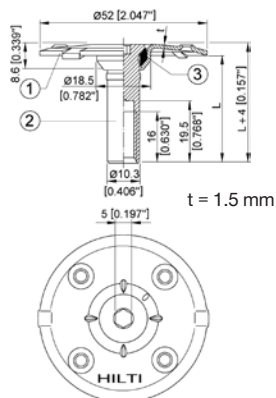

X-BT-GR M8/7 SN 8

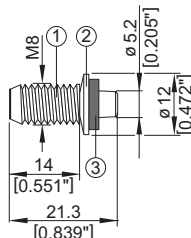

X-SEA-R30 M8

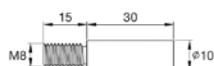

Features and benefits

The X-FCM-R HL together with the X-BT-GR M8 threaded fasteners forms a high resistance and robust fastening system to fix grating in marine C5 corrosive environment:

- High tension resistance for use in wave zones
- Robust shear behavior
- No rework of backside of coated base material with thickness ≥ 8 mm
- Base material coating up to 500 μm
- No application limits in terms of base material strength and thickness
- Vibration resistant

General information

Material specifications

Disk (1) and	A4 / 316
threaded stem (2):	1.4404, X2CrNiMo17-12-2
Absorber (3) ¹⁾ :	TPU – thermoplastic polyurethane, red

¹⁾ resistant to: UV, saltwater, ozone, oil, grease

X-SEA-R 30 M8:	A4 / 316
	1.4401 or 1.4571

Recommended fastening tools

See **X-FCM-R HL fastener program** in the next pages and **Tools and equipment** chapter for more details.

Approvals

ABS, BV
DNV GL, LR



Application

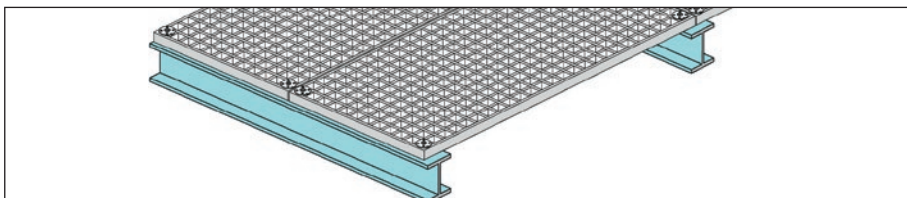

Position and fix steel or fibre-reinforced grating to steel

Load data

Recommended tensile loads N_{rec} [kN]

Grating opening type					Grating opening type	
Rectangular					Square	
Clear bar spacing [mm] ¹⁾					Clear mesh width [mm]	
18 to 24 >24 to 30 >30 to 35 >35 to 44					18 to 38 ²⁾ > 38 to 44 ¹⁾	
X-FCM-R HL	2.8	2.1	1.4	0.7	X-FCM-R HL	3.6 1.2

¹⁾ Loading is limited by elastic limit of the X-FCM-R HL grating fastener.

²⁾ Loading is limited by recommended load of threaded stud X-BT-GR M8/7 SN 8. Exceeding recommended loads might reduce the pre-tensioning of the connection.

Remark: Full utilization of X-FCM-R HL load data requires the use of the X-BT-GR M8/7 SN 8 threaded stud with $T = 16 - 20 \text{ Nm}$

Characteristic tensile loads N_{Rk} can be conservatively calculated by multiplying the recommended load values N_{rec} with the factor 2.8, $N_{Rk} = 2.8 * N_{rec}$

Recommended shear loads V_{rec} [kN]

Without extension adapter X-SEA-R

For grating with clear rectangular mesh width from 18 to 44 mm: $V_{rec} = 0.4 \text{ kN}$

For grating with clear square mesh width from 18 to 44 mm: $V_{rec} = 0.6 \text{ kN}$

With extension adapter X-SEA-R

For grating with clear rectangular or square mesh width from 18 to 44 mm: $V_{rec} = 0.4 \text{ kN}$

Notes:

Those recommended loads V_{rec} are based on friction under standard conditions without the presence of lubricants (e.g. oil, grease) and require the application of an installation torque $T = 16 - 20 \text{ Nm}$. The respective slips are in the range of 0.2 mm.

Those values allow robust positioning e.g. in case of transportation of preassembled units. Structural applications – e.g. stabilizing the compression flange of a supporting beam, if the grating is used as a diaphragm – are out of scope of the X-FCM-R HL grating fastener.

Load displacement behavior – examples:

Tensile load

Example with square grating and a clear mesh width of 30 x 30 mm

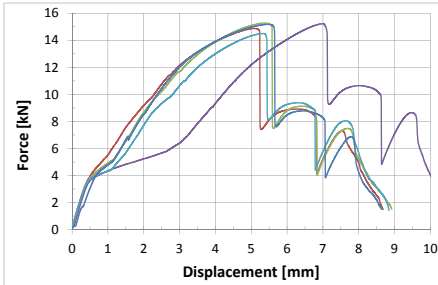

Failure mode: Pull-over of disk (1) over the threaded stem (2)

Shear load

Example with rectangular grating and a clear bar spacing of 44 mm

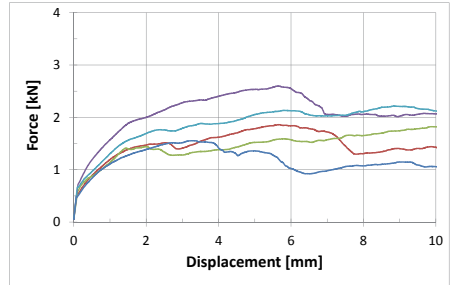

Notes:

Graph shows slipping behavior due to friction. The actual ultimate resistance will be significantly higher, as the grating itself will get into contact with the X-FCM-R HL fastener. However, those resistances are not used for design purpose due to the high deformation at those states.

Application requirements

Thickness of base material

X-BT-GR M8/7 SN8

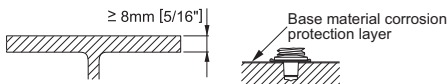

To prevent damage of back side coating: base material thickness ≥ 8 mm.

Thickness of base material corrosion protection considered up to 500 μm .

Thickness of fastened material

Grating height: 28–43 mm, 48–53 mm

Grating height: 58–73 mm, 78–83 mm with the extension adapter X-SEA-R30 M8.

Corrosion information

X-FCM-R HL and X-BT-GR grating fastening system is intended for use in coastal and offshore applications

Application limit

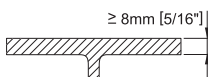

$t_{II} \geq 8$ mm [5/16"] \rightarrow No through penetration
No limits with regards to steel strength

Spacing and edge distance

Edge distance: $c \geq 10$ mm

Spacing: ≥ 15 mm

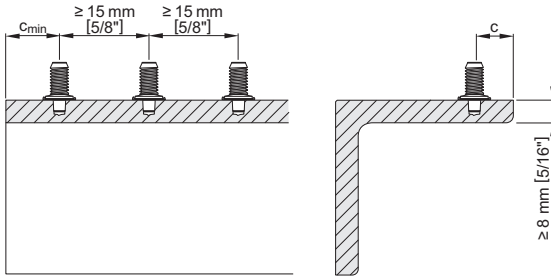

Fastener selection and system recommendation

Fastener program

X-FCM-R HL

Designation	Item no.	Dimensions	
		L [mm]	Grating height H_G [mm]
X-FCM-R HL 25/30	2194345	23	28 – 33
X-FCM-R HL 1" - 1¼"	2194346	27	32 – 37
X-FCM-R HL 35/40	2194347	33	38 – 43
X-FCM-R HL 45/50	2194348	43	48 – 53

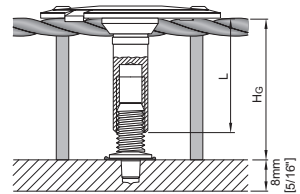

X-FCM-R HL in combination with X-SEA-R30 M8 (Item no. 432274)

Designation	Item no.	Dimensions	
		L [mm]	Grating height H_G [mm]
X-FCM-R HL 25/30	2194345	53	58 – 63
X-FCM-R HL 1" - 1¼"	2194346	57	62 – 67
X-FCM-R HL 35/40	2194347	63	68 – 73
X-FCM-R HL 45/50	2194348	73	78 – 83

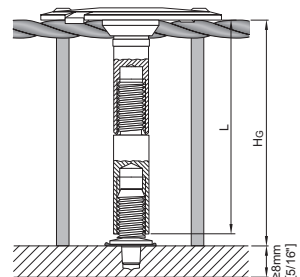

X-BT-GR stainless steel stud

Designation	Item no.	Tool
		Designation
X-BT-GR M8/7 SN 8	2194344	DX 351-BTG

Cartridge selection and tool energy setting

6.8/11 M10 high precision brown cartridge

The recommended tool energy setting = 1 (if required, increase of energy setting based on job site tests)

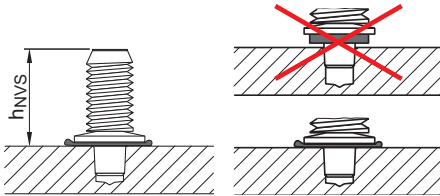
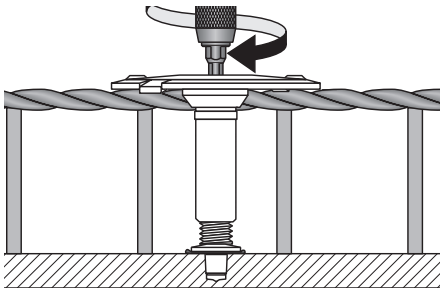
Fastening quality assurance
Fastening inspection

X-BT-GR M8/7 SN 8
 $h_{NVS} = 15.7-16.8 \text{ mm}$
Installation

Tightening torque $T = 16-20 \text{ Nm}$
Tightening tool:

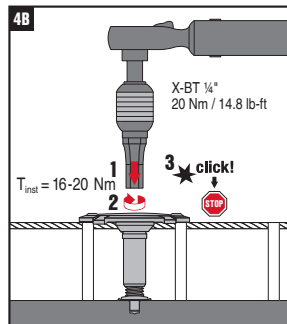
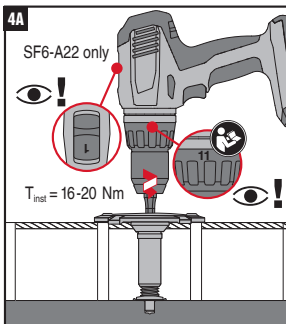
- Screwdriver (SF6, speed 1, clutch 11) with torque release coupling (TRC)
- 5 mm Allen-type bit
- Hilti torque tool X-BT ¼" 20 Nm

Details on installation are given in the instructions for use which are supplied together with the product.



X-FCI-M Grating fastening system

Product data

Dimensions

X-FCI-M and X-FCI-M L X-FCI-M C

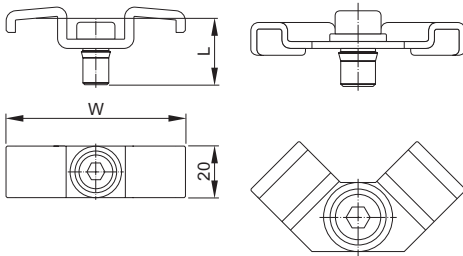

General information

Dimension

See main section Fastener selection and system recommendation for dimension W and L.

Material specifications

See section Material specifications and coatings in the next pages for more details.

Recommended fastening tools

See section Fastener selection and system recommendation in the next pages and Tools and Equipment chapter for more details.

X-ST-GR M8/10 P8

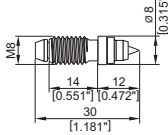

X-BT M8-15-6 SN12-R

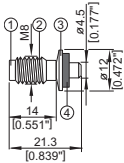

X-BT-GR M8/7 SN 8

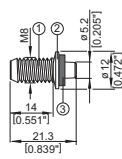

S-BT-GF M8/7 AN 6
S-BT-GR M8/7 SN 6
S-BT-GR M8/7 SN 6 AL

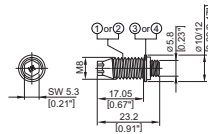

Application

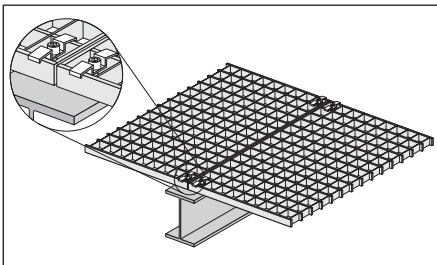

For fastenings exposed to weather and mildly corrosive conditions.

Not for use in marine atmospheres (upstream)!

Load data

Recommended tensile loads N_{rec} [kN]

$N_{rec} = 0.8 \text{ kN (180 lb)}$

Notes/Conditions:

- Tensile loading is limited by plastic deformation of the saddle clip
- X-FCI-M resists shear by friction and is not suitable for explicit shear load design

Application requirements

Thickness of base material

X-BT M8-15-6
SN12-R

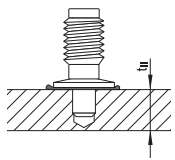

$t_{II} \geq 8 \text{ mm}$

X-BT-GR M8/7
SN 8

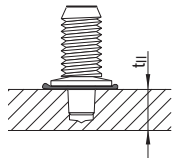

$t_{II} \geq 8 \text{ mm}$

S-BT-GF M8/7 AN 6
S-BT-GR M8/7 SN 6
S-BT-GR M8/7 SN 6 AL*)

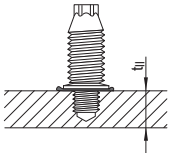

$t_{II} \geq 6 \text{ mm}$
pilot hole

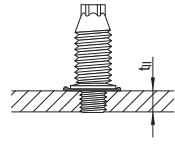

steel: $3 \text{ mm} \leq t_{II} < 6 \text{ mm}$, aluminum: $5 \text{ mm} \leq t_{II} < 6 \text{ mm}$
drill through hole

X-ST-GR

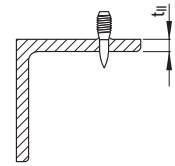

$t_{II} \geq 6 \text{ mm}$

*) for use in aluminum base material

Thickness of fastened material

Grating height: X-FCI-M:

HG = 28-52 mm (1.10" – 2.05"), other dimensions for X-FCI-M are available on demand.

See **Fastener selection** for detailed dimensions

Spacing and edge distances

X-ST-GR

Edge distances: $c \geq 15 \text{ mm}$

Spacing: $s \geq 15 \text{ mm}$

X-BT, X-BT-GR, S-BT

Edge distance: $c \geq 6 \text{ mm}$

Spacing: $s \geq 15 \text{ mm}$

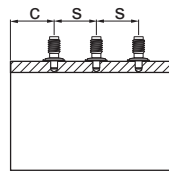
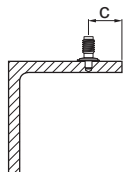

Corrosion information

X-FCI-M is used to weather and mildly corrosive conditions, not suitable for coastal and offshore applications.

X-BT, X-BT-GR and S-BT-GR stainless steel fasteners is suitable for coastal and offshore environment. However, they can only be used for weather and mildly corrosive conditions once combining with X-FCI-M.

The coating of the carbon steel S-BT fasteners consists of an electroplated Zn-alloy for cathodic protection and a top coat for chemical resistance (Duplex-coating). The thickness of the coating is 35 µm. The use of this coating is limited to the corrosion category C1, C2 and C3 according to the standard EN ISO 9223. For higher corrosion categories stainless steel fasteners should be used. In case of a drill through hole, rework of the coating on the back side of the plate/profile may be needed.

The intended use of the X-ST-GR fasteners comprises fastenings exposed to outdoor environments in mildly corrosive conditions where HDG coated parts are commonly specified or used. Not for use in atmospheres with chlorides (marine atmospheres) or in heavily polluted environments (e.g. sulphur dioxide).

Application limits

X-ST-GR:

DX 460, DX 5

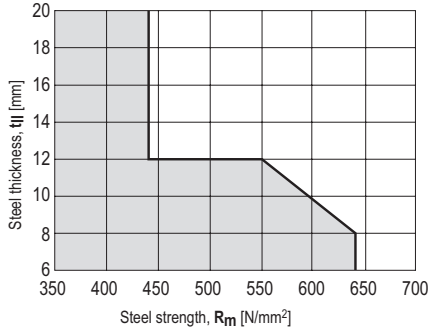

DX 76 PTR

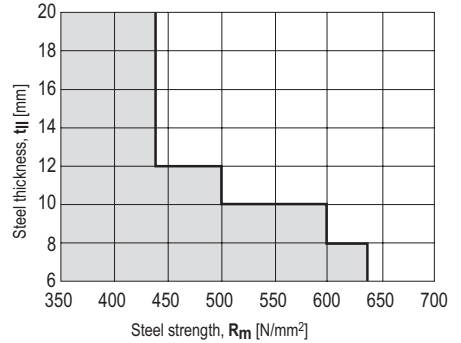

X-BT and X-BT-GR:

No application limits

→ using in high strength steel (f_u up to 1000 MPa)

No through penetration

→ $t_{II} \geq 8 \text{ mm}$ [$5/16''$]

S-BT:

The base material is limited to steel grade with a maximum tensile strength $f_u = 630 \text{ MPa}$ (91 ksi). The minimum tensile strength of steel is $f_u \geq 340 \text{ MPa}$ (49 ksi). The minimum tensile strength of aluminum is $f_u \geq 270 \text{ MPa}$ (39 ksi). Minimum thickness of base material t_{II} : refer to section "Thickness of base material" Maximum thickness of base material t_{II} : no limits

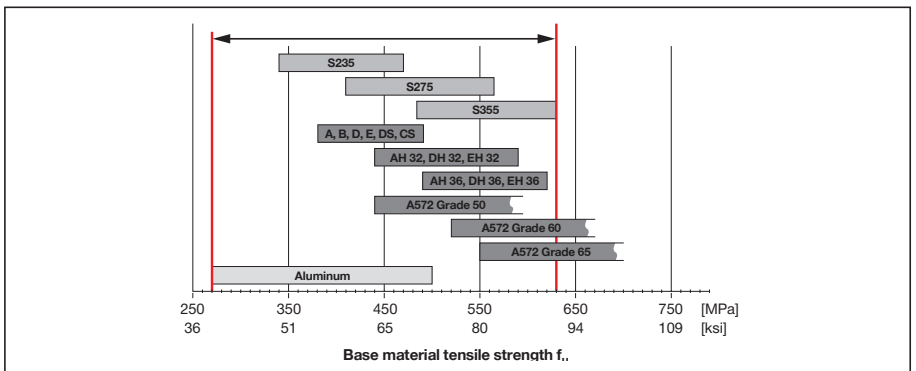

Fastener selection

Fastener	Item no.	W mm (inch)	L mm (inch)	Grating width a mm (inch)	Grating height H _G mm (inch)
X-FCI-M 28/32	2223485	40 (1.58")	22.5 (0.89")	23-38 (0.91"-1.50")	28-32 (1.10"-1.26")
X-FCI-M 33/37	2223486	40 (1.58")	27.5 (1.08")	23-38 (0.91"-1.50")	33-37 (1.30"-1.46")
X-FCI-M 38/42	2223487	40 (1.58")	32.5 (1.30")	23-38 (0.91"-1.50")	38-42 (1.50"-1.65")
X-FCI-M 43/47	2223488	40 (1.58")	37.5 (1.48")	23-38 (0.91"-1.50")	43-47 (1.69"-1.85")
X-FCI-M 48/52	2223489	40 (1.58")	42.5 (1.67")	23-38 (0.91"-1.50")	48-52 (1.89"-2.05")
X-FCI-M 28/32 L	2223661	67 (2.64")	21 (0.83")	35-65 (1.38"-2.56")	28-32 (1.10"-1.26")
X-FCI-M 33/37 L	2223662	67 (2.64")	26 (1.02")	35-65 (1.38"-2.56")	33-37 (1.30"-1.46")
X-FCI-M 38/42 L	2223663	67 (2.64")	31 (1.22")	35-65 (1.38"-2.56")	38-42 (1.50"-1.65")
X-FCI-M 43/47 L	2223664	67 (2.64")	36 (1.42")	35-65 (1.38"-2.56")	43-47 (1.69"-1.85")
X-FCI-M 48/52 L	2223665	67 (2.64")	41 (1.61")	35-65 (1.38"-2.56")	48-52 (1.89"-2.05")
X-FCI-M 28/32 C	2223667	32 (1.26")	21 (0.83")	30 + (1.18" +)	28-32 (1.10"-1.26")
X-FCI-M 33/37 C	2223668	32 (1.26")	26 (1.02")	30 + (1.18" +)	33-37 (1.30"-1.46")
X-FCI-M 38/42 C	2223669	32 (1.26")	31 (1.22")	30 + (1.18" +)	38-42 (1.50"-1.65")
X-FCI-M 43/47 C	2223670	32 (1.26")	36 (1.42")	30 + (1.18" +)	43-47 (1.69"-1.85")
X-FCI-M 48/52 C	2223671	32 (1.26")	41 (1.61")	30 + (1.18" +)	48-52 (1.89"-2.05")

Grating width of X-FCI-M _/_ (L)

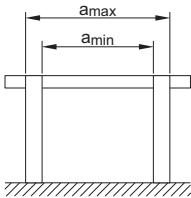

Grating height

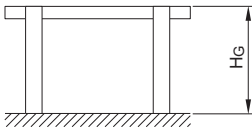

Grating width of X-FCI-M _/_ C

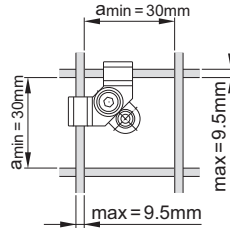

Threaded studs	Item no.
X-ST-GR M8/10 P8	2122460
X-BT M8-15-6 SN12-R	377074
X-BT-GR M8/7 SN 8	2194344
S-BT-GF M8/7 AN 6	2140527
S-BT-GR M8/7 SN 6	2140529
S-BT-GR M8/7 SN 6 AL	2140742

Cartridge selection and tool energy setting

- X-BT, X-BT-GR:** 6.8/11M high precision brown cartridges
X-ST-GR: 6.8/11M black or red cartridges with DX 460, DX 5
 6.8/18M yellow or red cartridges with DX 76 PTR

Tool energy adjustment by setting tests on site.

Material specifications and coatings

Fastener X-FCI-M	Saddle	Threaded stem	Washer ¹⁾
Material designation	DC0136	11SMNPB30+C	Stainless Steel 316
Coating	Duplex*	Duplex*	-

¹⁾ Metal washer only mounted on X-FCI-M L and X-FCI-M C items

*) comparable to 45 µm HDG steel (480 h Salt spray test per DIN 50021)

Threaded studs

	X-BT M8-15-6 SN12-R			X-ST-GR	
	Shank ①	Threaded sleeve ② SN12-R washer ③	Sealing ring of sealing washer ¹⁾ ④	Shank	Threaded sleeve
Material designation	Stainless steel 1.4462, CR 500 (A4 / AISI316)	X2CrNiMo17132 X5CrNiMo17122+2H (A4 / AISI316)	Elastomer, black	P558 (CrMnMo alloy)	(A4 / AISI316)
Coating	none	none		none	none

¹⁾ resistant to: UV, saltwater ozone, oil, grease

²⁾ Zinc applied by electroplating. Intended for corrosion protection during shipment, storage, construction and service in protected environment. It is not adequate for protection against corrosion in outside or otherwise corrosive applications

Threaded studs

	S-BT- <u>R</u> , X-BT-GR		Sealing ring of sealing washer ¹⁾ ③	S-BT- <u>F</u>		Sealing ring of sealing washer ¹⁾ ④
	Threaded Shank ①	SN 12-R washer ③		Threaded Shank ②	AN 10-F washer ④	
Material designation	Stainless steel 1.4462 (A4 / AISI316)	Stainless steel 1.4404 (A4 / AISI316)	Elastomer, black	Carbon steel 1038	Aluminum	Elastomer, black
Coating	Zinc ²⁾	none	none	Duplex-coating	none	HDG

¹⁾ resistant to: UV, salt water, ozone, oil, grease

²⁾ The surface of the S-BT stainless steel fasteners is zinc plated (anti-friction coating) in order to reduce the thread forming torque when the stud is screwed in into the base material.

³⁾ only S-BT is coated, X-BT-GR is uncoated

thread forming torque when the stud is screwed in into the base material.

Fastening quality assurance

Fastening inspection

X-BT M8-15-6 SN12-R

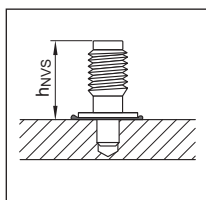

$h_{NVS} = 15.7 - 16.8 \text{ mm}$

X-BT-GR M8/7 SN 8

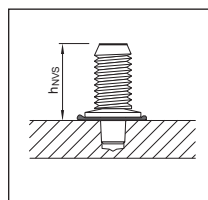

$h_{NVS} = 15.7 - 16.8 \text{ mm}$

X-ST-GR M8/10 P8

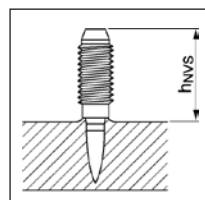

$h_{NVS} = 17.0 - 20.0 \text{ mm}$

S-BT-____/7____6

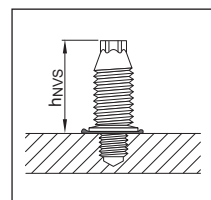

$h_{NVS} = 18.6 - 19.1 \text{ mm}$

Fastening quality assurance

Tighten the screw

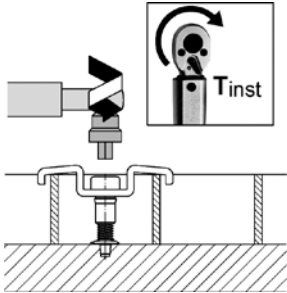

X-FCI-M and X-FCI-M L

$T_{rec} = 4-5 \text{ Nm}$
(3.0-3.7 ft-lb)

Tightening tool:

- Screwdriver with torque release coupling (TRC)
- 5 mm Allen-type bit

Hilti screwdriver	Gear	Torque setting
SF 14	2	5-6
SF 8M-A22	3	5
SF 10W-A22	4	4-5

X-FCI-M C

$T_{rec} = 6-8 \text{ Nm}$
(4.4-5.9 ft-lb)

Tightening tool:

- Screwdriver with torque release coupling (TRC)
- 5 mm Allen-type bit

Hilti screwdriver	Gear	Torque setting
SF 14	1	7
SF 8M-A22	3	7
SF 10W-A22	4	6

X-FCS Grating fastening system

Product data

Dimensions

X-FCS-R-3-25 31/35
X-FCS-R-3-25 37/41

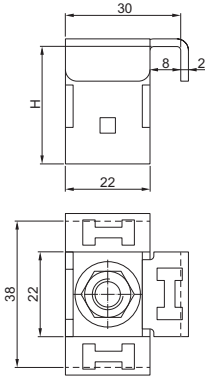

X-FCS-R-4-25 31/35
X-FCS-R-4-25 37/41

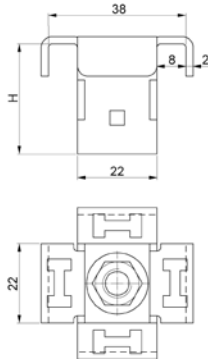

Features and benefits

The X-FCS system is an approved Fastening on Steel system for grating fastening with tensile and shear resistance capability.

General information

Material specification

See sub-section Material specifications in the next pages for more details.

Recommended fastening tools

See sub-section Fastener program in the next pages for more details.

Fastener approvals

ABS, BV, DNV-GL, LR



Fasteners

X-BT M8-15-6 SN12-R

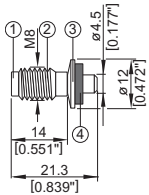

X-BT-GR M8/7 SN 8

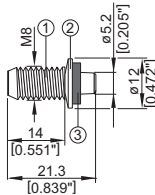

S-BT-GR M8/7 SN 6

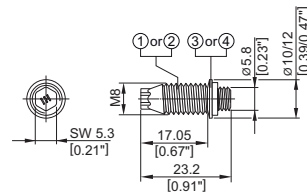

Application examples

X-FCS-R-3-25 31/35 and 37/41

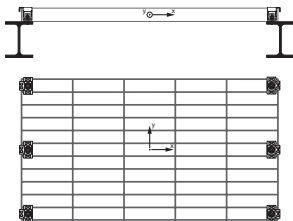

X-FCS-R-4-25 31/35 and 37/41

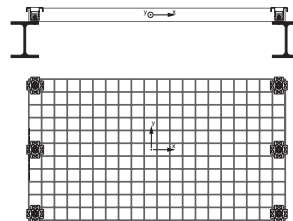

Grating fastening solution for shear relevant zones, e.g. gratings subjected to equipment movement, grating fastening on jackets, etc.

Load data

Recommended loads of individual X-FCS with X-BT and S-BT-GR

Tensile load N_{rec} [kN]		Shear load direction	Shear load V_{rec} [kN]	
S235 / A36 steel	S355 / Grade 50 steel		S235 / A36 steel	S355 / Grade 50 steel
1.8	2.3	a	2.6	3.2
		b	0.8	0.8
		c	2.6	3.2

Shear load directions

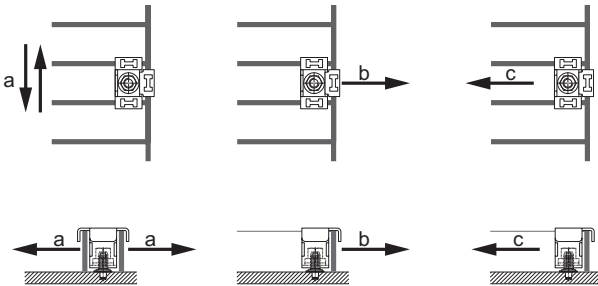

Interaction formula for combined load:

$$\frac{V}{V_{rec}} + \frac{N}{N_{rec}} \leq 1.2$$

Design loads of individual X-FCS with X-BT and S-BT-GR

Tensile load N_{Rd} [kN]		Shear load direction	Shear load V_{Rd} [kN]	
S235 / A36 steel	S355 / Grade 50 steel		S235 / A36 steel	S355 / Grade 50 steel
2.5	3.2	a	3.6	4.5
		b	1.1	1.1
		c	3.6	4.5

Load data
Recommended loads of individual X-FCS with X-BT-GR M8/7 SN 8

Tensile load N_{rec} [kN]				Shear load direction	Shear load V_{rec} [kN]
S235 / A36 steel		S355 / Grade 50 steel			For all grades \geq (S235/A36) and for both X-FCS-R-4 and FCS-R-3
X-FCS-R-4	X-FCS-R-3	X-FCS-R-4	X-FCS-R-3		
3.6	2.6	4.6	2.6	a	4.3
				b	0.8
				c	4.3

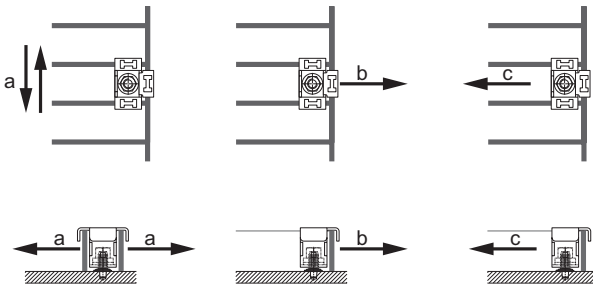
Shear load directions

Interaction formula for combined load:

$$\frac{V}{V_{rec}} + \frac{N}{N_{rec}} \leq 1.2$$

Design loads of individual X-FCS with X-BT-GR M8/7 SN 8

Tensile load N_{Rd} [kN]				Shear load direction	Shear load V_{Rd} [kN]
S235 / A36 steel		S355 / Grade 50 steel			For all grades \geq (S235/A36) and for both X-FCS-R-4 and FCS-R-3
X-FCS-R-4	X-FCS-R-3	X-FCS-R-4	X-FCS-R-3		
5.0	3.6	6.4	3.6	a	6.0
				b	1.1
				c	6.0

Design examples for grating component

Example: Recommend load for rectangular grating fastened with X-BT and/or S-BT-GR + X-FCS-R-3-25 with symmetrical loadings

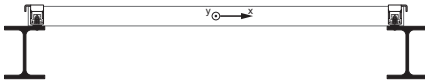

Steel : S235

$$N_{GR,rec} = 2 \cdot n \cdot N_{rec} \\ = 2 \cdot 3 \cdot 1.8 = 10.8 \text{ kN}$$

$$V_{GR,y,rec} = 2 \cdot n \cdot V_{rec,a} \\ = 2 \cdot 3 \cdot 2.6 = 15.6 \text{ kN}$$

$$V_{GR,x,rec} = n_1 \cdot V_{rec,c} \\ = 3 \cdot 2.6 = 7.8 \text{ kN}$$

3 no. of X-FCS-R-3-25 per side of rectangular grating

- No. of X-FCS on side 1, $n_1 = 3$ ¹⁾
- No. of X-FCS on side 2, $n_2 = 3$ ¹⁾

1) In event when different no. of X-FCS are used on each side of rectangular grating, the no. of X-FCS on side with less X-FCS will be considered as control in y-direction, i.e. $n = \min(n_1, n_2)$

Note: Due to lower stiffness of the X-FCS in b-direction compared with c-direction, the resistance in b-direction is conservatively neglected when calculating the resistance $V_{GR,x,Rd}$ or $V_{GR,x,rec}$ of rectangular grating.

Example: Design resistance of square grating fastened with X-BT and/or S-BT-GR + X-FCS-R-4-25 with symmetrical loadings

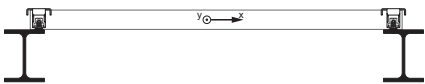

Steel : S355

$$N_{GR,Rd} = 2 \cdot n \cdot N_{Rd} \\ = 2 \cdot 3 \cdot 3.2 = 19.2 \text{ kN}$$

$$V_{GR,y,Rd} = 2 \cdot n \cdot V_{Rd,a} \\ = 2 \cdot 3 \cdot 4.5 = 27.0 \text{ kN}$$

$$V_{GR,x,Rd} = (n_1 + n_2) \cdot V_{Rd,a} \\ = (3 + 3) \cdot 4.5 = 27.0 \text{ kN}$$

3 no. of X-FCS-R-4-25 per side of rectangular grating

- No. of X-FCS on side 1, $n_1 = 3$ ¹⁾
- No. of X-FCS on side 2, $n_2 = 3$ ¹⁾

1) In event when different no. of X-FCS are used on each side of rectangular grating, the no. of X-FCS on side with lesser X-FCS will be considered as control in y-direction, i.e. $n = \min(n_1, n_2)$

Application requirements

Thickness of base material

X-BT and X-BT-GR

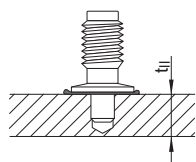

$$t_{II} \geq 8 \text{ mm}$$

S-BT-GR

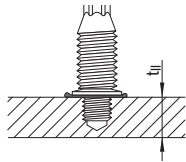

$$t_{II} \geq 6 \text{ mm}$$

S-BT-GR

$t_{II} = 5 \text{ mm}$ is acceptable if penetration of the base material is acceptable.

Grating height and opening size

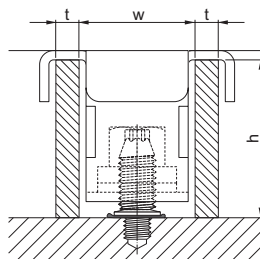
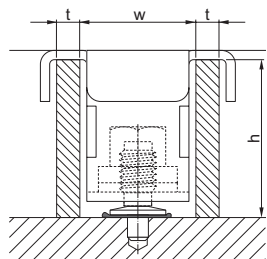

	Bar spacing, w [mm]	Bar thickness, t [mm]	Height, h [mm]
X-FCS-R-3-25 31/35	25	5	31 - 35
X-FCS-R-3-25 37/41			37 - 41
X-FCS-R-4-25 31/35			31 - 35
X-FCS-R-4-25 37/41			37 - 41

Edge distance and fastener spacing

X-BT, X-BT-GR and S-BT-GR

Edge distance: $c \geq 10 \text{ mm}$

Spacing: $s \geq 15 \text{ mm}$

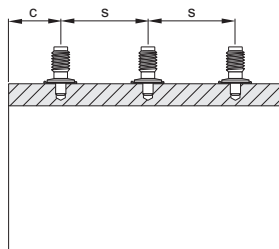
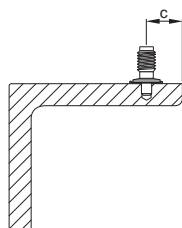

Corrosion information

The X-BT, X-BT-GR and S-BT-GR stainless fasteners are made from the duplex stainless steel type 1.4462, which is equivalent to AISI 316 (A4) steel grade.

This grade of stainless steel is classified in the corrosion resistance class IV according to DIN EN 1993-1-4:2015, which makes the material suitable for aggressive environments like in coastal and offshore applications.

Application limits

X-BT and X-BT-GR: No application limits → using in high strength steel
 No through penetration → $t_{II} \geq 8 \text{ mm [5/16"]}$

S-BT:

The base material is limited to steel grade with a maximum tensile strength $f_u = 630 \text{ MPa}$ (91 ksi). The minimum tensile strength of steel is $f_u \geq 340 \text{ MPa}$ (49 ksi).

Maximum thickness of base material t_{II} : no limits

Fastener selection and system recommendation

Fastener program

	Item no.	Tools
X-FCS-R-3-25 31/35	2198296	Screw drivers: SF 100-A, SF 11-A, SF 150-A, SF 121-A, SF 14, SF 14-A, SF 18-A, SFC 18-A, SF 22-A, SFC 22-A, SBT 4-A22
X-FCS-R-3-25 37/41	2198297	
X-FCS-R-4-25 31/35	2198298	
X-FCS-R-4-25 37/41	2198299	
		Nut setter: S-NS 12 C 95/3 3/4" (Item no. 2219157)

Tightening torque, $T_{rec} = 8 \text{ Nm}$ (for use with X-BT and S-BT-GR)
 $= 20 \text{ Nm}$ (for use with X-BT-GR M8/7 SN 8)

Threaded studs	Item no.	Tools	
X-BT M8-15-6 SN12-R	377074	BX 3-BTG, DX 351-BTG	
X-BT-GR M8/7 SN8	2194344		
S-BT-GR M8/7 SN6	2140529	Drilling the hole	SF BT 18-A, SF BT 22-A and SBT 4-A22
		Screwing in the fastener	SFC 18-A, SFC 22-A and SBT 4-A22

Cartridge selection and tool energy setting

X-BT and X-BT-GR: **6.8/11M high precision brown cartridges**

Tool energy adjustment by setting tests on site.

Material specifications

X-FCS	Body	Threaded nut
Material designation	A4 / 316L	A4 / 316

X-BT M8-15-6 SN12-R		X-BT-GR M8/7 SN 8 and S-BT-GR M8/7 SN 6	
① Shank: CR500 (CrNiMo alloy) S 31803 (1.4462) N 08926 (1.4529) 1	equivalent to A4 / AISI grade 316 material Available on request	Shank:	Stainless steel S 31803 (1.4462) zinc-coated (only S-BT)
② Threaded sleeve:	S 31609 (X5CrNiMo 17-12-2+2H, 1.4401)		
③ SN12-R washers:	S 31635 (X2CrNiMo 17-12-2, 1.4404)	SN12-R washers:	Ø 12 mm [0.47"] Stainless steel S 31635 (1.4404)
④ Sealing washers	Chloroprene rubber CR 3.1107, black*	Sealing washers	Chloroprene rubber CR 3.1107, black*

* Resistant to UV, salt water, water, ozone, oils, etc.

¹⁾ For High Corrosion Resistance HCR material inquire at Hilti

Fastening quality assurance

Fastening inspection

X-BT M8-15-6 SN12-R

S-BT-GR M8/7 SN 6

X-BT-GR M8/7 SN 8

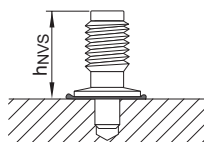

$h_{NVS} = 15.7 - 16.8 \text{ mm}$

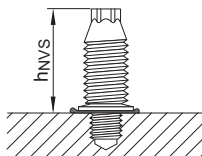

$h_{NVS} = 18.6 - 19.1 \text{ mm}$

X-GR Grating fastening system

Product data

Dimensions

X-GR an X-GR-L

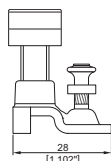
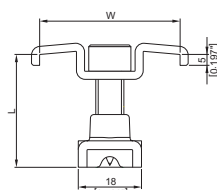

X-GR C

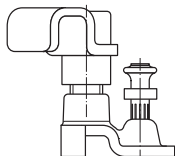

X-R 20-4.0 Zn P8

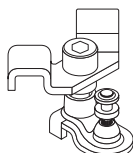
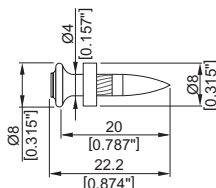

See Fastener selection for detailed dimensions

General information

Material specifications

Screw:

Carbon steel

Zinc coating: Duplex* coated

Nail:

Stainless steel: CrMnMo Alloy and zinc coated

Upper part:

Carbon steel: DD11 or DC01

Zinc coating: Duplex* coated

Bottom part:

Carbon steel: S315MC or DC04

Zinc coating: Duplex* coated

*) 480 h salt spray test per DIN 50021 and 10 cycles
Kesternich test per DIN 50018/2.0 (comparable to 45 µm HDG steel)

Recommended fastening tools

DX 460 GR and **DX 5 GR** with

X-5-460-F8GR fastener guide

See **X-GR fastener program** in the next pages and **Tools and equipment** chapter for more details.

Application

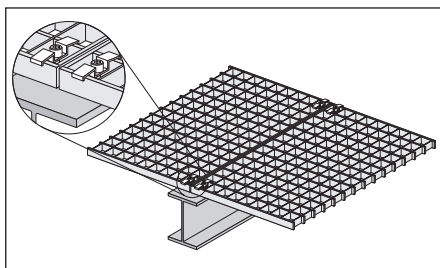

Fastening of grating

For fastenings exposed to weather and mildly corrosive conditions.

Not for use in marine atmospheres (upstream)!

Load data

Recommended tensile loads N_{rec} [kN]

$N_{rec} = 0.8 \text{ kN (180 lb)}$

Notes/Conditions:

- Tensile loading is limited by plastic deformation of the saddle clip
- X-GR resists shear by friction and is not suitable for explicit shear load designs
- For X-GR C: In case of dynamic load
 $N_{rec} = 0.6 \text{ kN (135 lb)}$

Application requirements

Thickness of base material

$t_{II} \geq 4 \text{ mm (0.157"')}$

Thickness of fastened material

Grating $H_G = 23\text{-}52 \text{ mm (0.91" - 2.05"')}$

height: Standard X-GR (X-GR 25/30, X-GR 1 1/4", X-GR 35/40):

See Fastener selection for detailed dimensions

Specials X-GR (X-GR 33/37, X-GR 43/47, X-GR 48/52, X-GR _/_ L and X-GR _/_ C):

Other dimensions special X-GR are available on demand

Grating opening types

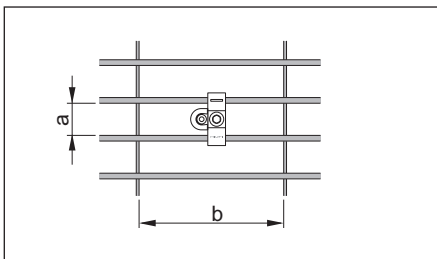

a : see Fastener selection

$b \geq 30 \text{ mm (1.18"')}$

Edge distances

$c \geq 15 \text{ mm (0.59"')}$

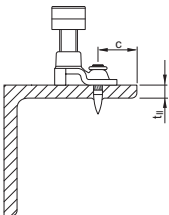

Corrosion information

For fastenings exposed to weather and mildly corrosive conditions. **Not for use in marine atmospheres (upstream)** or in heavily polluted environments.

Application limits

X-GR with DX 460, DX 5

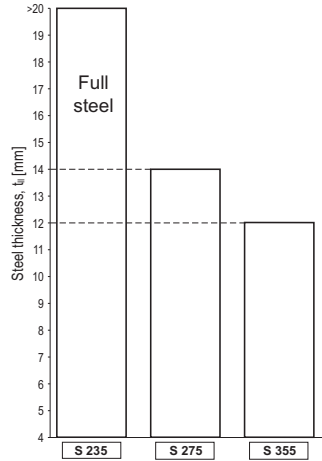
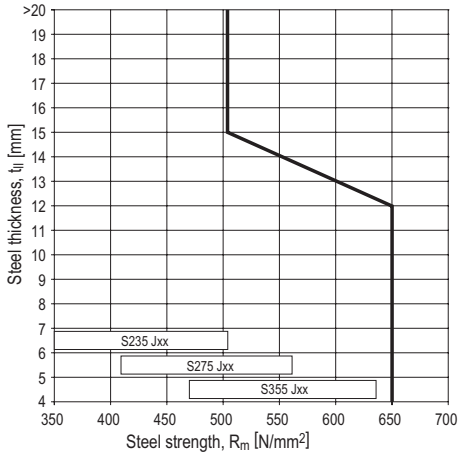

- S235: No application limit
- S275: Full coverage of grade up to 14mm base material thickness
- S355: Full coverage of grade up to 12mm base material thickness

Fastener selection

Fastener	Item no.	W mm (inch)	L mm (inch)	Grating width a mm (inch)	Grating height H _G mm (inch)
X-GR 25/30	2106415 or 2154241	40 (1.58")	32 (1.26")	23-38 (0.91"-1.50")	25-30 (0.98"-1.18")
X-GR 1 1/4"	2106416 or 2154243	40 (1.58")	34 (1.34")	23-38 (0.91"-1.50")	27-32 (1.06"-1.26")
X-GR 35/40	2106417 or 2154242	40 (1.58")	42 (1.65")	23-38 (0.91"-1.50")	35-40 (1.38"-1.57")
X-GR 33/37	2222597	40 (1.58")	32 (1.26")	23-38 (0.91"-1.50")	33-37 (1.30"-1.46")
X-GR 43/47	2222598	40 (1.58")	42 (1.65")	23-38 (0.91"-1.50")	43-47 (1.69"-1.85")
X-GR 48/52	2222599	40 (1.58")	47 (1.85")	23-38 (0.91"-1.50")	48-52 (1.89"-2.05")
X-GR 23/27 L	2222640	65 (2.56")	32 (1.26")	35-65 (1.38"-2.56")	23-27 (0.91"-1.06")
X-GR 28/32 L	2222641	65 (2.56")	37 (1.46")	35-65 (1.38"-2.56")	28-32 (1.10"-1.26")
X-GR 33/37 L	2222642	65 (2.56")	42 (1.65")	35-65 (1.38"-2.56")	33-37 (1.30"-1.46")
X-GR 38/42 L	2222643	65 (2.56")	47 (1.85")	35-65 (1.38"-2.56")	38-42 (1.50"-1.65")
X-GR 43/47 L	2222644	65 (2.56")	52 (2.05")	35-65 (1.38"-2.56")	43-47 (1.69"-1.85")
X-GR 48/52 L	2222645	65 (2.56")	57 (2.24")	35-65 (1.38"-2.56")	48-52 (1.89"-2.05")
X-GR 23/27 C	2222646	32 (1.26")	32 (1.26")	30 + (1.18" +)	23-27 (0.91"-1.06")
X-GR 28/32 C	2222647	32 (1.26")	37 (1.46")	30 + (1.18" +)	28-32 (1.10"-1.26")
X-GR 33/37 C	2222648	32 (1.26")	42 (1.65")	30 + (1.18" +)	33-37 (1.30"-1.46")
X-GR 38/42 C	2222649	32 (1.26")	47 (1.85")	30 + (1.18" +)	38-42 (1.50"-1.65")
X-GR 43/47 C	2222650	32 (1.26")	52 (2.05")	30 + (1.18" +)	43-47 (1.69"-1.85")
X-GR 48/52 C	2222651	32 (1.26")	57 (2.24")	30 + (1.18" +)	48-52 (1.89"-2.05")

Grating width of X-GR _/_ and X-GR _/_ L

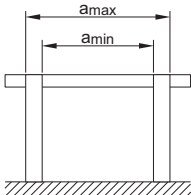

Grating height

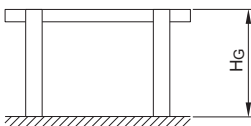

Grating width of X-GR _/_ C

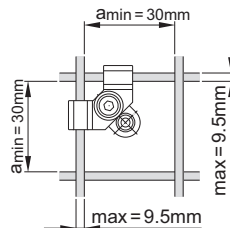

Cartridge selection and tool energy setting

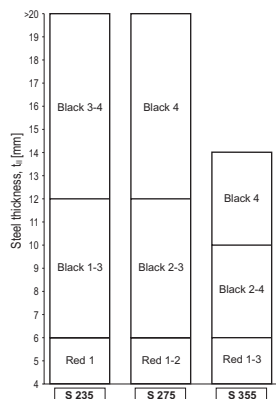

DX 460, DX 5 with 6.8/11M cartridges

Fastening quality assurance

Standard X-GR (X-GR 25/30, X-GR 1 1/4", X-GR 35/40):

Tighten the screw

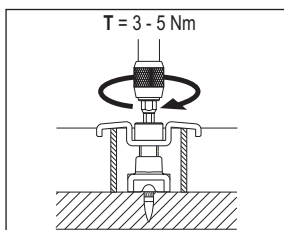

$T_{rec} = 3 - 5 \text{ Nm}$
(4.4 - 5.9 ft-lb)

Tightening tool:

- Screwdriver with torque release coupling (TRC)
- 6 mm Allen-type bit

Hilti screwdriver	Gear	Torque setting
SF 14-A	3	5
SFC 14-A	2	6-7
SF 8M-22	4	4-6
SF 10W-22	4	4-5

Special X-GR (X-GR 33/37, X-GR 43/47, X-GR 48/52, X-GR _/_ L and X-GR _/_ C):

Tighten the screw

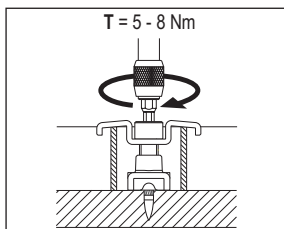

$T_{rec} = 5 - 8 \text{ Nm}$
(3.7 - 5.9 ft-lb)

Tightening tool:

- Screwdriver with torque release coupling (TRC)
- 6 mm Allen-type bit

X-GR 33/37, X-GR 43/47, X-GR 48/52, X-GR _/_ L:		
Hilti screwdriver	Gear	Torque setting
SF 14-A	1	5-6
SF 8M-22	3	3-5
SF 10W-22	3	3-5

X-GR _/_ C:		
Hilti screwdriver	Gear	Torque setting
SF 14-A	1	3-5
SF 8M-22	4	3-5
SF 10W-22	4	3-5

Fastening inspection

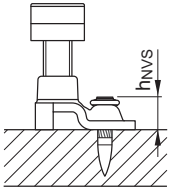

$$h_{NVS} = 7 - 10.5 \text{ mm (0.28v'' - 0.41'')}$$

Observing the cartridge selection and tool energy setting typically leads to a stand-off between 9 and 10 mm.

X-PGR-RU Grating fastening system (pre-drilled)

Product data

Dimensions

X-PGR-RU

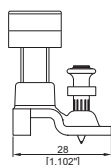
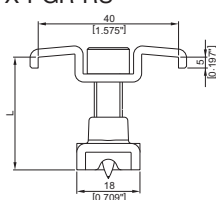

X-CR 20-4.5R P8

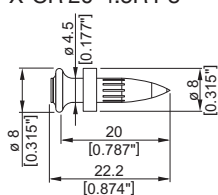

General information

Material specifications

Screw:

Carbon steel

Zinc coating: Duplex* coated

Nail:

Stainless steel: CrNiMo Alloy

Upper part:

Carbon steel: DD11

Zinc coating: Duplex* coated

Bottom part:

Carbon steel: S315MC

Zinc coating: Duplex* coated

*) 480 h salt spray test per DIN 50021 and 10 cycles
Kesternich test per DIN 50018/2.0 (comparable to
45 µm HDG steel)

Recommended fastening tools

DX 460 GR and **DX 5 GR** with

X-5-460-F8GR fastener guide

See **X-PGR-RU fastener program** in the next pages
and **Tools and equipment** chapter for more details.

Application

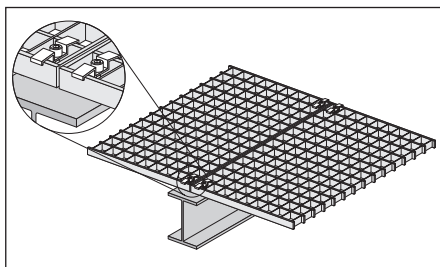

Fastening of grating

For fastenings exposed to weather and mildly corrosive conditions.

Not for use in marine atmospheres (upstream)!

Load data
Recommended tensile loads N_{rec} [kN]
 $N_{rec} = 0.8 \text{ kN (180 lb)}$
Notes/Conditions:

- Tensile loading is limited by plastic deformation of the saddle clip
- X-PGR-RU resists shear by friction and is not suitable for explicit shear load designs

Application requirements
Thickness of base material
 $t_{II} \geq 6 \text{ mm (0.24")}$
Thickness of fastened material

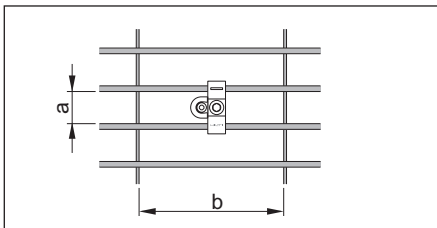
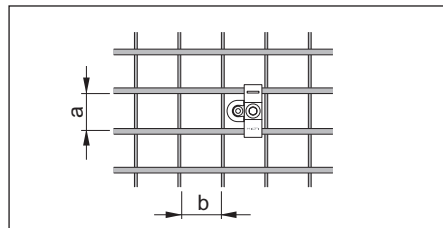
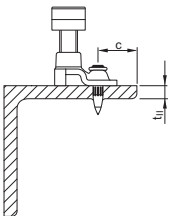
 Grating height: $H_G = 25\text{--}40 \text{ mm (0.98"--1.57")}$
Grating opening types
Bearing bar spacing (a)

 $a \text{ from } 25 \text{ to } 32 \text{ mm (1" to } 1\frac{1}{4}\text{")}$
Cross bar spacing (b)

 $b \geq 30 \text{ mm (1.18")}$
Edge distances
 $c \geq 15 \text{ mm (0.59")}$

Corrosion information

For fastenings exposed to weather and mildly corrosive conditions. **Not for use in marine atmospheres (upstream)** or in heavily polluted environments.

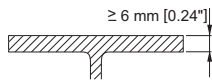
Application limits

Application limits

X-PGR-RU with DX 460, DX 5 (pre-drilled)



- $t_{||} \geq 6 \text{ mm [0.24"]}$
- $350 \text{ N/mm}^2 \leq \text{Steel strength, } R_m \leq 630 \text{ N/mm}^2$

Fastener selection and system recommendation

Fastener program

Fastener	Item no.	L mm (inch)	Grating height mm (inch)
X-PGR-RU 25/30	2061313	32 (1.26 ^{''})	25–30 (0.98 ^{''} –1.18 ^{''})
X-PGR-RU 1 ¹ / ₄ ''	2061314	34 (1.34 ^{''})	27–32 (1.06 ^{''} –1.26 ^{''})
X-PGR-RU 35/40	2061315	42 (1.65 ^{''})	35–40 (1.38 ^{''} –1.57 ^{''})

Cartridge selection and tool energy setting

DX 460, DX 5 with 6.8/11M red cartridges, power setting 1–2

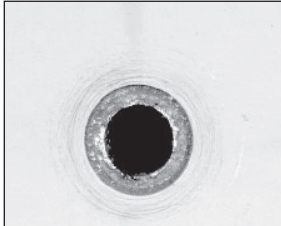
Fastening quality assurance
Installation
Pre-drill

Pre-drill with TX-PGR-RU-4/10-93 step shank drill bit (Item no. 2061802), until shoulder grinds a shiny ring (to ensure proper drilling depth).

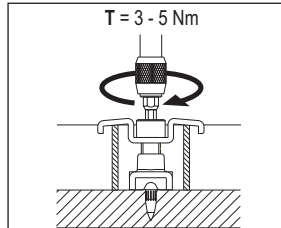
Tighten the screw

$T_{rec} = 3-5 \text{ Nm}$ (2.2-3.7 ft-lb)

Tightening tool:

- Screwdriver with torque release coupling (TRC)
- 6 mm Allen-type bit

Hilti screwdriver	Torque setting
SF 121-A	4-7
SF 150-A	3-5
SF 14	3-5
SFC 14-A	4-7
SF 18-A	3-5
SFC 18-A	3-5
SFC 22-A	3-5
SBT 4-A22	3-4

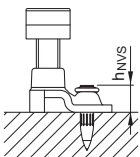
Fastening inspection

$h_{NVS} = 8-10 \text{ mm}$ (0.31"-0.39")

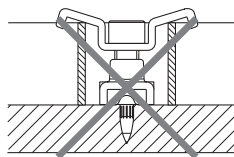

The saddle of the fastener should not be bent, see installation instruction above.

These are abbreviated instructions which may vary by application.
ALWAYS review/follow the instructions accompanying the product.

X-MGR Grating fastening system

Product data

Dimensions

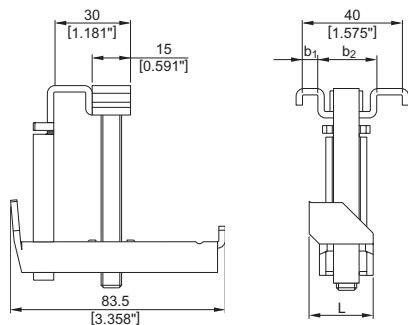

General information

Material specifications

Screw:	
Carbon steel	
Zinc coating:	60 µm HDG
Upper part:	
Carbon steel:	SPCC-S
Zinc coating:	65 µm HDG
Bottom part:	
Carbon steel:	SPCC-S
Zinc coating:	65 µm HDG
Nut:	
Carbon steel	
Zinc coating:	45 µm HDG
Nut-holder:	
Stainless steel:	SS304

Recommended fastening tools

**SF 121-A, SF150-A, SF 14, SFC 14-A ,
SF 18-A, SFC 18-A, SF 22-A**

See **X-MGR fastener program** in the next pages and **Tools and equipment** chapter for more details.

Application

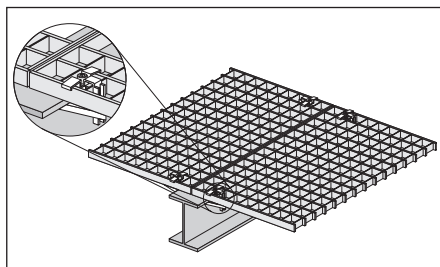

Fixing of grating

For fastenings exposed to weather and mildly corrosive conditions.

Not for use in marine atmospheres (upstream)!

Load data

Recommended tensile loads N_{rec} [kN]

$N_{rec} = 0.6 \text{ kN (135 lb)}$

Notes/Conditions:

- Tensile loading is limited by plastic deformation of the saddle clip
- X-MGR resists shear by friction and is not suitable for explicit shear load designs

Application requirements

Thickness of base material

$t_{II} = 3 - 25 \text{ mm (0.118 - 0.984")}$

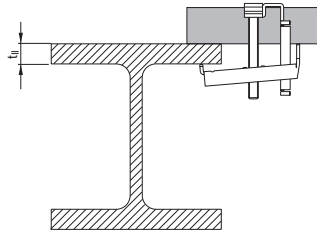

Thickness of fastened material

Grating height:

$H_G = 25 - 40 \text{ mm (0.98 - 1.57")}$

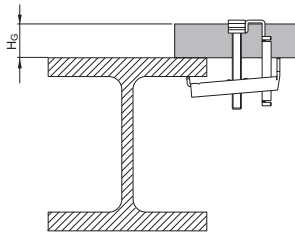

Total fastening height

$H_G + t_{II} \leq 65 \text{ mm (2.56")}$

Grating opening types

Fastener	a mm (inch)	b mm (inch)	c mm (inch)
X-MGR M60	30 (1.18")	$\geq 30 (1.18")$	$\leq 3 (0.118")$
X-MGR W60	25 (0.98")	$\geq 30 (1.18")$	$\leq 4.8 (\frac{3}{16})$

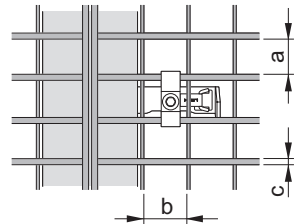

Spacing and edge distances

No general restriction exists.

Corrosion information

For fastenings exposed to weather and mildly corrosive conditions. **Not for use in marine atmosphere (Upstream)** or in heavily polluted environment.

Fastener selection and system recommendation

Fastener program

Fastener	Item-no.	Steel flange thickness t_{fl} mm (inch)	Grating height mm (inch)	Fastening tool
X-MRG-M60	384233	3-25 (0.12"-0.98")	25-40 (0.98"-1.57")	SF 121-A, SF 150-A
X-MRG-W60	384234	3-25 (0.12"-0.98")	25-40 (0.98"-1.57")	SF 121-A, SF 150-A

Fastening quality assurance

Fastening inspection

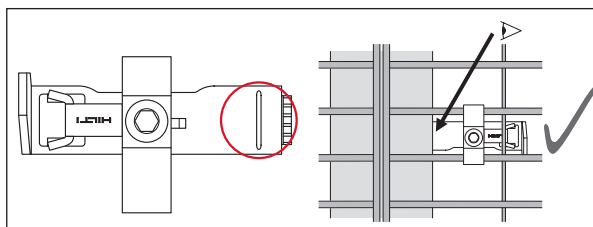

The sign on the clip has to be positioned under the steel flange

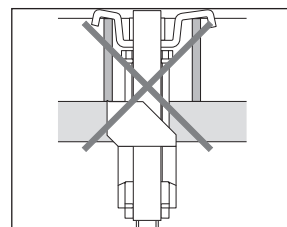

The saddle of the fastener should not be bent, see installation instructions below.

Tighten the screw

$T = 5 - 8 \text{ Nm}$

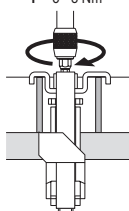

$T_{rec} = 5-8 \text{ Nm}$ (3.7-5.9 ft-lb)
Hilti Torque tool X-BT 1/4"

Hilti screwdriver

Torque setting

SF 121-A	6-10
SF 150-A	5-8
SF 14	5-8
SFC 14-A	6-10
SF 18-A	5-8
SFC 18-A	5-8
SF 22-A	5-8
SFC 22-A	4-5
SBT 4-A22	4-5

X-FCP Checker plate fastening system

Product data

Dimensions

X-FCP-R 5/10

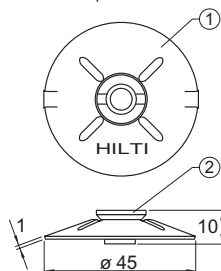

X-FCP-F 5/10

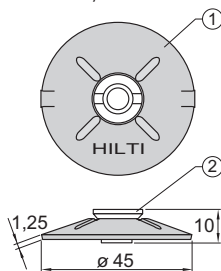

General Information

Material specifications

See fastener selection for more details.

Recommended fastening tools

See **X-FCP fastener program** in the next pages and **Tools and equipment chapter** for more details.

Approvals

LR: X-FCP
 ABS, LR: X-FCP-R
 ABS: X-FCP-F



X-FCP Sealing ring

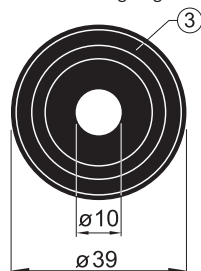

X-ST-GR M8/5 P8

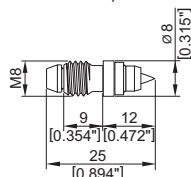

X-CRM8-15-12 FP10

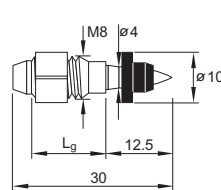

X-CRM8-9-12 P8

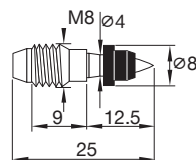

X-ST-GR M8/10 P8

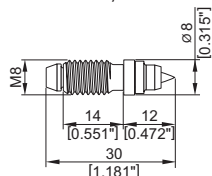

X-CRM8-9-12 FP10

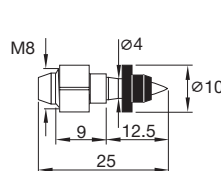

X-CRM8-15-12 P8

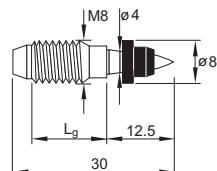

Application

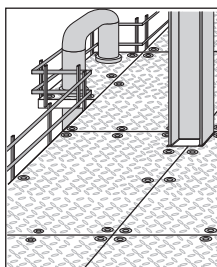

Checker plate

Load data

Recommended loads:

$N_{rec} = 1.8 \text{ [kN]}$

Conditions:

- Limited by the strength of the X-CRM8 and X-ST-GR threaded stud.
- Recommended loads are valid for fastenings of steel and aluminium with 20 mm pre-drilling.
- **X-FCP-F** and **X-FCP-R** are not intended for shear loading.

Application requirements

Thickness of base material

X-CRM8 , X-ST-GR

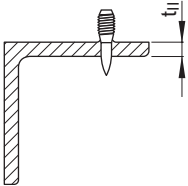

Minimum steel thickness $t_{II} \geq 6 \text{ mm}$

Thickness of fastened material

Thickness of chequer plates:

$t_I \approx 5.0\text{--}13.0 \text{ mm}$

Spacing and edge distances

X-CRM8, X-ST-GR

Edge distances: $c \geq 15 \text{ mm}$

Spacing: $s \geq 15 \text{ mm}$

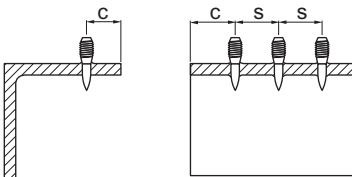

Application limits

DX 76, DX 76 PTR

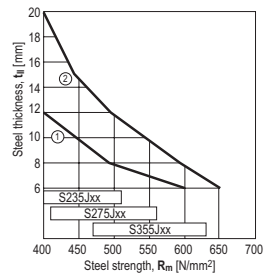

- ① **X-CRM8-__-12 FP10** / DX 76 (impact)
- ② **X-CRM8-__-12 FP10** / DX 76 (co-acting)

$t_{II} \geq 6 \text{ mm}$

DX 460, DX 5

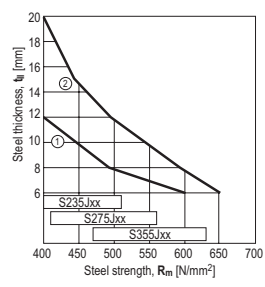

- ① **X-CRM8-__-12 P8** / DX 460, DX 5 (impact)
- ② **X-CRM8-__-12 P8** / DX 460, DX 5 (co-acting)

$t_{II} \geq 6 \text{ mm}$

Note:

For co-acting operation push the fastener all the way back against the piston with a ramrod.

X-ST-GR:

Steel: DX 76 PTR

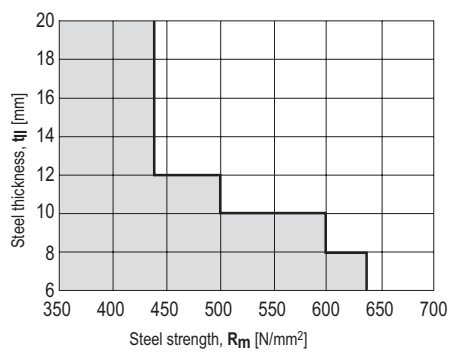

Steel: DX 460, DX 5

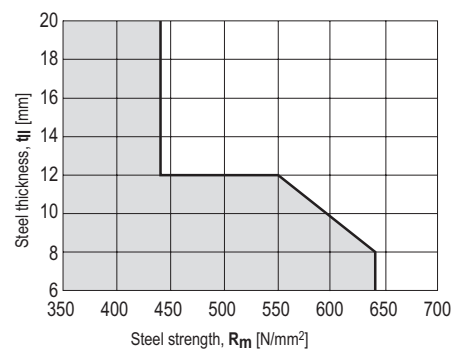

Fastener selection and system recommendation

Fastener program

Application areas

Marine, offshore, petrochemical, caloric (coal, oil) power plants, etc.	Indoors, mildly corrosive environment, or for limited lifetime use
---	--

X-FCP system

X-FCP-R Item no. 308860 Note: Not for use in automobile tunnels, swimming pools or similar environments	X-FCP-F Item no. 308859 Note: Not for use in marine atmosphere or in heavily polluted environment.	Sealing ring Drip-through of water/oil needs to be prevented	Tools SF 120-A, SF 150-A
--	---	--	------------------------------------

Threaded studs

Designation	Chequer plate thickness	Tools
X-CRM8-15-12	9–13 mm	DX 460, DX 5, DX 76, DX 76 PTR
X-CRM8-9-12	5– 8 mm	DX 460, DX 5, DX 76, DX 76 PTR
X-ST-GR M8/10 P8	9–13 mm	DX 460, DX 5, DX 76 PTR
X-ST-GR M8/5 P8	5– 8 mm	DX 460, DX 5, DX 76 PTR

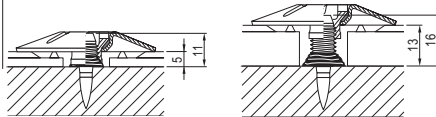

Cartridge selection and tool energy setting

Threaded studs		Tools
X-CRM8	6.8/11M red cartridges	DX 460, DX 5
	6.8/18M yellow cartridges	DX 76, DX 76 PTR
X-ST-GR	6.8/11M black or red cartridges	DX 460, DX 5
	6.8/18M yellow or red cartridges	DX 76 PTR

Tool energy adjustment by setting tests on site.

Material and coatings

X-FCP system

	X-FCP-R		X-FCP-F		All Systems
	① Disk	② Screw	① Disk	② Screw	③ Sealing ring
Material designation	X5CrNiMo17122	X2CrNiMo17132	ST2K40 BK	9SMnPb28 K	Neoprene, black
Coating	none	none	Duplex *	Duplex *	

*) 480 h Salt spray test per DIN 50021 and 10 cycles Kesternich test per DIN 50018/2.0 (comparable to 45 µm HDG steel)

X-ST-GR		
	Shank	Threaded sleeve
Material designation	P558 (CrMnMo ally)	A4 (AISI316)
Coating	none	none

Threaded studs X-CRM8		
	X-CR shank	CRM8 threaded sleeve
Material designation	Stainless steel wire, CR 500 (A4 / AISI316)	X2CrNiMo17132 X5CrNiMo17122+2H (A4 / AISI316)
Coating	none	none

Fastening quality assurance

Fastening inspection

X-CRM8-9-12

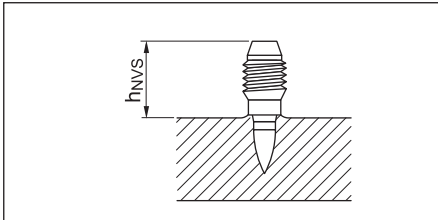

$h_{NVS} = 12.0 - 15.0 \text{ mm}$

X-CRM8-15-12

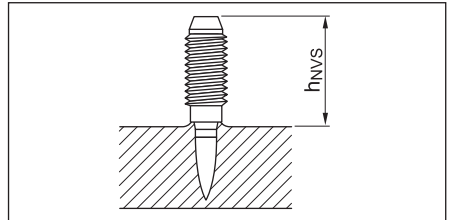

$h_{NVS} = 17.0 - 20.0 \text{ mm}$

X-ST-GR

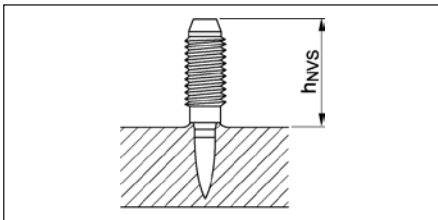

X-ST-GR M8/5 P8, $h_{NVS} = 12.0 - 15.0 \text{ mm}$
 X-ST-GR M8/10 P8, $h_{NVS} = 17.0 - 20.0 \text{ mm}$

Plates must be
pre-drilled or pre-punched

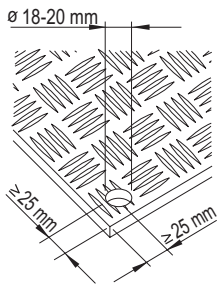

Tighten the disk

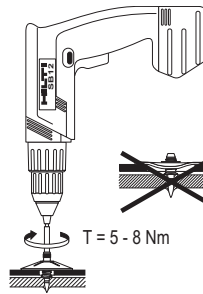

Tightening torque

$T_{\text{rec}} = 5-8 \text{ Nm}$

Tightening tool:

- Screwdriver with torque release coupling (TRC)
- S-NSX 2.8 x 15 bit

Hilti	Torque
Screwdriver	setting
SF 120-A	TRC 5.5-7
SF 150-A	TRC 8-9

Hilti Torque tool X-BT 1/4"

X-IE-G Insulation fastener

Product data

Dimensions

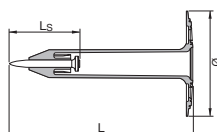
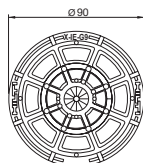
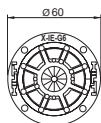
X-IE-G 6
X-IE-G 9

Features and benefits

The GX-IE insulation fastening system comprised of gas tool and insulation fasteners for insulation application with various thicknesses of hard and soft board on soft concrete.

General information

Material specifications

Plate:	X-IE-G 6 – HDPE, colorless X-IE-G 9 – HDPE, black (BK)
Nail:	Carbon steel shank: HRC 57.5 Zinc coating: 2–13 µm

Recommended fastening tools

GX IE, GX IE XL

See **X-IE-G fastener program** in the next pages and **Tools and equipment** chapter for more details.

Applications and suitable insulation materials

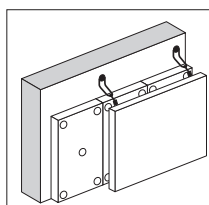
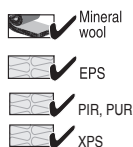

Insulation behind curtain walls

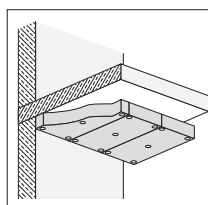

Insulation in ceilings

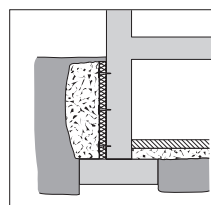

Insulation of basement perimeter/foundation walls

In general:

the fastener is supposed to be used with insulation boards of max. tolerances of +/- 3 mm.

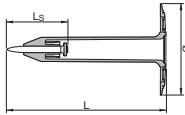
Fastener program
Fastener selection

Select fastener with designation equivalent to the insulation thickness t_i .

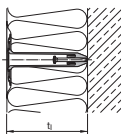
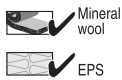
**Soft insulation boards
(Mineral wool, EPS):**

Fasteners are allowed to be countersunk as shown in the drawing.

Note:

For mineral wool of intermediate thicknesses use next shorter X-IE-G. For soft mineral wool use X-IE-G 9.

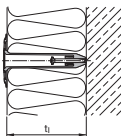
**Hard insulation boards
(XPS, PIR, PUR):**

The fastener is not countersunk, fastener disc needs to be flush with the board prior to installation as shown in the drawing.

For convenience, pre-core the board before installation.

Designation	Fastener X-PH Ls	Item no.	Insulation thickness t_i [mm]
X-IE-G 6-25	X-P 36 G3	2192914	25
X-IE-G 6-30	X-P 36 G3	2163810	30
X-IE-G 6-40	X-P 36 G3	2163811	40
X-IE-G 6-50	X-P 36 G3	2163812	50
X-IE-G 6-60	X-P 36 G3	2163813	60
X-IE-G 6-70	X-P 36 G3	2163814	70
X-IE-G 6-75	X-P 36 G3	2192915	75
X-IE-G 6-80	X-P 36 G3	2163815	80
X-IE-G 6-90	X-P 36 G3	2192916	90
X-IE-G 6-100	X-P 36 G3	2163816	100
X-IE-G 6-120	X-P 36 G3	2192917	120
X-IE-G 6-130	X-P 36 G3	2192918	130
X-IE-G 6-140	X-P 36 G3	2163817	140
X-IE-G 6-150	X-P 36 G3	2163818	150
X-IE-G 6-160	X-P 36 G3	2163819	160
X-IE-G 6-180	X-P 36 G3	2163820	180
X-IE-G 6-200	X-P 36 G3	2163821	200
X-IE-G 9-40	X-P 36 G3	2172154	40
X-IE-G 9-50	X-P 36 G3	2172155	50
X-IE-G 9-60	X-P 36 G3	2172156	60
X-IE-G 9-80	X-P 36 G3	2172157	80
X-IE-G 9-100	X-P 36 G3	2172158	100
X-IE-G 9-120	X-P 36 G3	2172159	120
X-IE-G 9-140	X-P 36 G3	2163823	140
X-IE-G 9-150	X-P 36 G3	2192919	150
X-IE-G 9-160	X-P 36 G3	2163824	160
X-IE-G 9-180	X-P 36 G3	2163825	180
X-IE-G 9-200	X-P 36 G3	2163826	200

Note:

For intermediate thicknesses, use the next longer X-IE-G.

System recommendation

Tool: GX-IE , GX-IE XL

Gas can: GC52

Application requirements

Thickness of base material

Concrete: $h_{min} = 80 \text{ mm}$

Thickness of fastened material

Insulation thickness t_i [mm]:

X-IE-G 6 (for the use with mineral wool, EPS, XPS, PIR, PUR): 25 – 200

X-IE-G 9 (for the use with very soft mineral wool): 40 – 200

Edge distances and minimum number of X-IE-G

For spacing of insulation fasteners, and minimum distances to the insulation edges, please consult with the insulation material supplier. If spacing recommendations are not available from supplier, please use a minimum of 5 X-IE G fasteners per m^2

Performance Data (Base material: concrete)

Recommended load

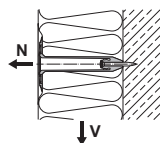

Tension (kN)	Shear (kN)
0.1	0.1

Conditions:

- Minimum of 5 fastenings per m^2 . All visible setting failures must be replaced
- Soft concrete up to $f_{c,cube} = 45 \text{ N/mm}^2$ (C35/45)
- When base material properties are questionable, jobsite qualification is necessary.

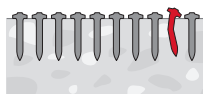

Stick rate estimation

	Soft Concrete
X-IE-G	Up to 90%

- The stick rate indicates the percentage of nails that were driven correctly to carry a load. Stick rate can vary from the above values depending on job site conditions.

Thermal efficiency

Point thermal transmittance [W/K]

Basement perimeter insulation	60 mm:	$\chi = 0.003$
	70 – 100mm:	$\chi = 0.002$
	120 – 200 mm:	$\chi = 0.001$
Curtain wall insulation	60 – 90 mm:	$\chi = 0.002$
	100 – 200mm:	$\chi = 0.001$

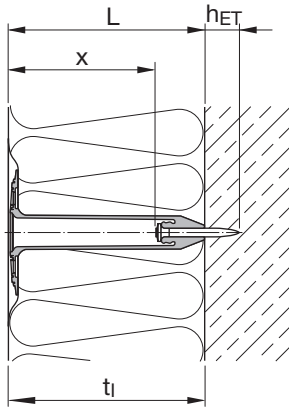
Fastening quality assurance
Fastening inspection

Insulation thickness t_i [mm]							
25/30	40	50	60	70	75	80	90

$h_{ET} = 12-19$ mm								
x_{min} [mm]	3	14	24	34	44	49	54	64
x_{max} [mm]	10	21	31	41	51	56	61	71

Insulation thickness t_i [mm]							
100	120	130	140	150	160	180	200

$h_{ET} = 12-24$ mm								
x_{min} [mm]	74	94	104	114	124	134	154	174
x_{max} [mm]	81	100	111	121	131	141	161	181

These are abbreviated instructions which may vary by application.

ALWAYS review/follow the instructions accompanying the product.

X-IE, X-IE-E Insulation fastener

Product data

Dimensions

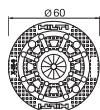
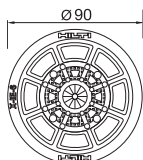
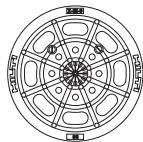
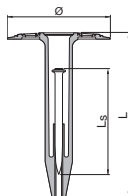
X-IE 6

X-IE 9

HDT 90

General information

Material specifications

Plate:	X-IE 6 – HDPE, colourless
	X-IE 9 – HDPE, black (BK)
	X-IE-E 6 – HDPE, colourless
Nail:	Carbon steel shank: HRC 58
	Zinc coating: 5–20 µm

Recommended fastening tools

DX 460 IE, DX 460 IE XL, DX 5 IE, DX 5 IE XL

See **X-IE fastener program** in the next pages and **Tools and equipment** chapter for more details.

Approvals

SOCOTEC WX 1530 (France)

Note: technical data presented in these approvals and design guidelines reflect specific local conditions and may differ from those published in this handbook.

Applications and suitable insulation materials

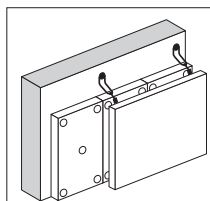
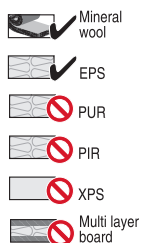

Insulation behind curtain walls

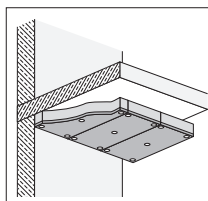

Insulation in ceilings

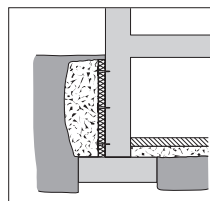

Temporary fixing of insulation of moisture barriers/drainage plates

Barriers: All materials are suitable

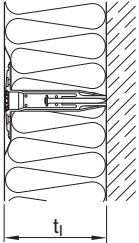
Fastener program
Fastener selection

Select Fastener Length $L = t_i$

In general:

The fastener length L must be equal to the thickness t_i of mineral wool and EPS insulation material, as shown in the drawing above.

Exceptions:

For mineral wool of intermediate thicknesses use next shorter X-IE.
Not for use with PUR, PIR, XPS, Multi layer boards or similar hard material not listed on this page.

Note:

For soft mineral wool use X-IE 9. Or X-IE 6 with HDT 90/HDT 90 BK.

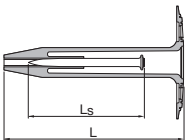

Designation	Fastener X-PH Ls	Item no.	Insulation thickness t_i [mm]
X-IE 6-20	X-PX 47	2143956	20
X-IE 6-25	X-PX 47	2041714	25
X-IE 6-30	X-PX 52	2041715	30
X-IE 6-35	X-PX 52	2041716	35
X-IE 6-40	X-PX 52	2041717	40
X-IE 6-50	X-PX 62	2041718	50
X-IE 6-60	X-PX 62	2041719	60
X-IE 6-70	X-PX 62	2041740	70
X-IE 6-75	X-PX 62	2041741	75
X-IE 6-80	X-PX 62	2041742	80
X-IE 6-90	X-PX 62	2041743	90
X-IE 6-100	X-PX 62	2041744	100
X-IE 6-120	X-PX 62	2041745	120
X-IE 6-140	X-PX 62	2041393	140
X-IE 6-150	X-PX 62	2048523	150
X-IE 6-160	X-PX 62	2041394	160
X-IE 6-180	X-PX 62	2041395	180
X-IE 6-200	X-PX 62	2041396	200
X-IE 9-50 BK	X-PX 62	2092034	50
X-IE 9-60 BK	X-PX 62	2041746	60
X-IE 9-80 BK	X-PX 62	2041747	80
X-IE 9-90 BK	X-PX 62	2041748	90
X-IE 9-100 BK	X-PX 62	2041749	100
X-IE 9-120 BK	X-PX 62	2041750	120
X-IE 9-140 BK	X-PH 62	2041751	140
X-IE 9-160 BK	X-PX 62	2041752	160
X-IE 9-180 BK	X-PX 62	2041753	180
X-IE 9-200 BK	X-PX 62	2041754	200
X-IE-E-6-40	X-U 42	2143953	40
X-IE-E-6-50	X-U 42	2075810	50
X-IE-E-6-60	X-U 42	2075813	60
X-IE-E-6-80	X-U 42	2143954	80
X-IE-E-6-100	X-U 42	2075814	100
X-IE-E-6-150	X-U 42	2143955	150

System recommendation

Tool

DX 460 IE, DX 460 IE XL, DX 5 IE, DX 5 IE XL

Cartridge selection and tool energy setting

Cartridge recommendation:

X-IE:	Steel:	6.8/11M yellow or red cartridge
	Concrete	6.8/11M yellow or red cartridge
	Masonry:	6.8/11M yellow or green cartridge
X-IE-E:	Steel:	6.8/11M yellow cartridge
	Concrete	6.8/11M yellow or green cartridge
	Masonry:	6.8/11M green cartridge

Tool energy adjustment by setting tests on site.

Application requirements

Thickness of base material

Concrete:	$h_{\min} = 80 \text{ mm}$
Steel:	$t_{II} \geq 4 \text{ mm}$

Thickness of fastened material

Insulation thickness:

X-IE: $t_I = 20 - 200 \text{ mm}$

X-IE-E: $t_I = 40 - 150 \text{ mm}$

Spacing and edge distances

For setting instructions please inquire at the insulation material supplier.

If recommendations from suppliers are not available, please use minimum 3 pcs of X-IE fasteners per insulation material and ≥ 5 pcs of X-IE fasteners per m^2

Application limits

Concrete:	$f_{cc} = 15-35/45^*) \text{ N/mm}^2$	(aggregate size $\leq 32 \text{ mm}$)
Sand-lime masonry:	$f_{cc} = 15-45 \text{ N/mm}^2$	
Clinker brick work:	$f_{cc} = 28-45 \text{ N/mm}^2$	
Steel:	$f_u = 360-540 \text{ N/mm}^2$	($t_{II} = 4-6 \text{ mm}$)

*) for X-IE-E, $f_{cc,max} = 35 \text{ N/mm}^2$. For X-IE, $f_{cc,max} = 45 \text{ N/mm}^2$.

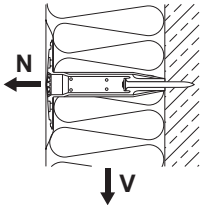
Load data

Recommended loads

	Insulation thickness t_i [mm]				
	40	50	60-70	75	80-200
X-IE 6, X-IE-E 6	Shear, V_{rec} [N]				
Polystyrol - EPS [30 kg/m ³]	150	250	300	325	350
X-IE 6	Pullover, N_{rec} [N]				
Polystyrol - EPS [30 kg/m ³]	250	290	300	300	300
X-IE-E 6	Pullover, N_{rec} [N]				
Polystyrol - EPS [30 kg/m ³]	-	200	200	-	200
X-IE 9, HDT 90	Pullover, N_{rec} [N]				
Mineral wool [≥ 7.5 kN/m ²]*	-	-	135	135	135
Mineral wool [≥ 15 kN/m ²]*	-	-	250	250	250

*) Tensile Strength σ_{mt} according to DIN EN 1607

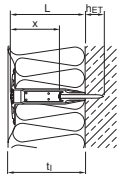
When base material properties are questionable, jobsite qualification is necessary

Fastening quality assurance
Fastening inspection

 Insulation thickness t_i [mm] for X-IE

40	50	60	70	75	80	90	100	120	140	150	160	180	200
----	----	----	----	----	----	----	-----	-----	-----	-----	-----	-----	-----

$h_{ET} = 24-29$ mm

x_{min} [mm]	9	9	19	29	34	39	49	59	79	99	109	119	139	159
x_{max} [mm]	14	14	24	34	39	44	54	64	84	104	114	124	144	164

 Insulation thickness t_i [mm] for X-IE-E

40	50	60	80	100	150
----	----	----	----	-----	-----

$h_{ET} = 19-24$ mm

x_{min} [mm]	13.1	23.1	33.1	53.1	73.5	123.1
x_{max} [mm]	18.1	28.1	38.1	58.1	78.5	128.1

X-IE-H Insulation fastener for hard board

Product data

Dimensions

X-IE-H

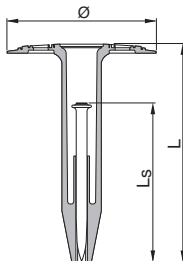
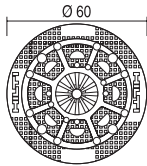

General information

Material specifications

Plate: HDPE, white

Nail: Carbon steel shank: HRC 58

Zinc coating: 5–20 µm

Recommended fastening tools

DX 460 IE, DX 460 IE XL, DX 5 IE, DX 5 IE XL

See **X-IE fastener program** in the next pages and **Tools and equipment** chapter for more details.

Applications and suitable insulation materials

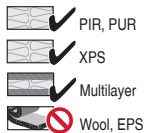

Barriers:
All materials are suitable

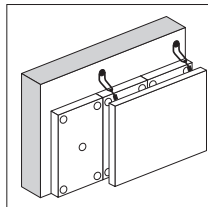

Insulation behind curtain walls

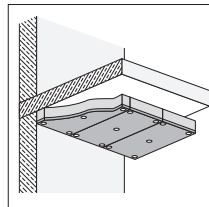

Insulation in ceilings

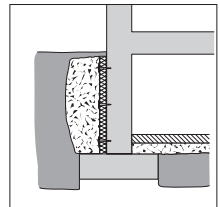

Temporary fixing of insulation of moisture barriers / drainage plates

In general: the fastener is intended to be used with insulation boards of type hard boards (PIR, PUR, XPS, Phenolic) produced according to the standard EN 13165 table 2 with tolerance classes T2 or T3.

Fastener program

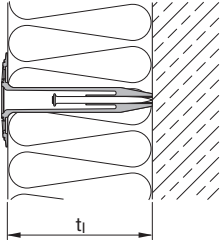

Select Fastener with Designation equivalent to the insulation thickness t_i

Exceptions:

For intermediate thicknesses, use the next longer X-IE-H.

Note:

For convenience, use insulation corer X-IE-KC (item no. 2163629) for pre-coring the hard board.

Fastener selection table

Designation	Fastener X-PH, Ls	Item no.	Insulation thickness t_i [mm]
X-IE-H 50	X-PX 62	2162046	50
X-IE-H 60	X-PX 62	2162047	60
X-IE-H 80	X-PX 62	2162048	80
X-IE-H 100	X-PX 62	2162049	100

Note: the fastener length L is not equal to the insulation thickness t_i due to the intention of avoiding any countersunk effect of the fastener into the insulation board, $L = t_i + 6$ mm.

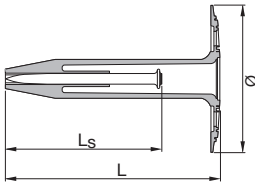

System recommendation

Tool

DX 460 IE, DX 460 IE XL, DX 5 IE, DX 5 IE XL

Cartridge selection and tool energy setting

Cartridge recommendation: Steel: **6.8/11M yellow or red cartridge**
 Concrete **6.8/11M yellow or red cartridge**

Tool energy adjustment by setting tests on site.

Application requirements

Thickness of base material

Concrete: $h_{\min} = 80 \text{ mm}$

Steel: $t_{II} \geq 4 \text{ mm}$

Thickness of fastened material

Insulation thickness: $t_I = 50 - 100 \text{ mm}$

Edge distances and minimum number of X-IE-H

For minimum distances to insulation edges please inquire at the insulation material supplier. Please use minimum 4 pcs of X-IE-H fasteners per insulation plate and ≥ 5 pcs of X-IE-H fasteners per m^2

Application limits

Concrete: $f_{cc} = 15 - 45 \text{ N/mm}^2$ (aggregate size $\leq 32 \text{ mm}$)

Sand-lime masonry: $f_{cc} = 15 - 45 \text{ N/mm}^2$

Clinker brick work: $f_{cc} = 28 - 45 \text{ N/mm}^2$

Steel: $f_u = 360 - 540 \text{ N/mm}^2$ ($t_{II} = 4-6 \text{ mm}$)

Load data

Recommended loads

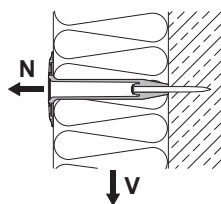

	Insulation thickness t_I [mm]			
	50	60	80	100
Shear, V_{rec} [N]	250	300	350	350
Tension, N_{rec} [N]	290	300	300	300

When base material properties are questionable, jobsite qualification is necessary

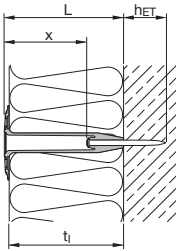
Fastening quality assurance
Fastening inspection

	Insulation thickness t_i [mm]			
	50	60	80	100
$h_{ET} = 24-29$ mm				
x_{min} [mm]	14	24	44	64
x_{max} [mm]	19	29	49	69

These are abbreviated instructions which may vary by application.

ALWAYS review/follow the instructions accompanying the product.

XI-FV ETICS Insulation fastener

Product data

Dimensions

XI-FV

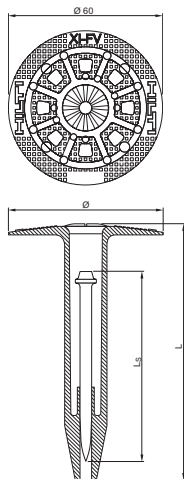

HDT-FV 90



HDT-FV 140

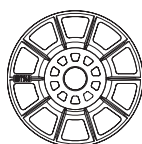

General information

Material specifications

Plate: XI-FV – HDPE, Orange
 HDT-FV – HDPE, Orange

Nail: Carbon steel shank: HRC 58
 Zinc coating: Delta-Tone

Recommended fastening tools

DX 460 IE, DX 460 IE XL, DX 5 IE, DX 5 IE XL

See **XI-FV fastener program** in the next pages for more details.

Approvals

ETA-17/0304, DOP no. Hilti-DX-DoP-006

For more information please contact Hilti.

Note: technical data presented in these approvals and design guidelines reflect specific local conditions and may differ from those published in this handbook.

Applications

Examples

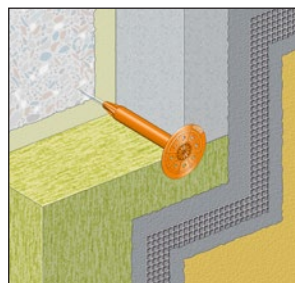

External Thermal Insulation Composite System (ETICS)

The XI-FV fastener is used to transfer wind suction loads acting on the thermal insulation composite system. The base material is normal weight concrete, which is either uncoated or coated with plaster or tiles. Coatings with plaster or tiles is often met if existing buildings are renovated and are improved with regards to their thermal insulation properties.

Load data and application requirements

Fixing element		XI-FV
Characteristic tension resistance in uncoated concrete fastener pull-out	$N_{Rk,p} =$	1.0 kN
Partial safety factor, fastener pull-out	$\gamma_M =$	2.0
Partial safety factor for variable action of wind suction forces	$\gamma_Q =$	1.5
Mean anchorage depth	$h_V =$	30 mm
Spacing	$s_c \geq$	100 mm
Edge distance	$c_c \geq$	75 mm
Corner distance	$c_e \geq$	100 mm
Thickness of concrete member	$h \geq$	100 mm

Characteristic resistance in concrete which is coated with plaster or tiles, see ETA-17/0304

Design value of resistance: $N_{Rd} = N_{Rk,p} / \gamma_M$

Design value of action: $N_{Sd} = N_{Sk} \cdot \gamma_Q$
 $N_{Sd} \leq N_{Rd}$

Please refer to ETA-17/0304 for detailed information on:

- the intended use (e.g. thickness of plaster and adhesive layer)
- verification of setting energy by means of control tests
- plate stiffness and point thermal transmittance

In case of concrete coated with plaster and tiles, the characteristic tension pull-out resistance needs in general be verified by job-site tests in accordance with EOTA Technical Report TR52: Recommendations for job-site tests of powder-actuated fasteners for ETICS for use in concrete.

Applicable insulation material are EPS and mineral wool.

Schematic illustration of spacings of fixing elements

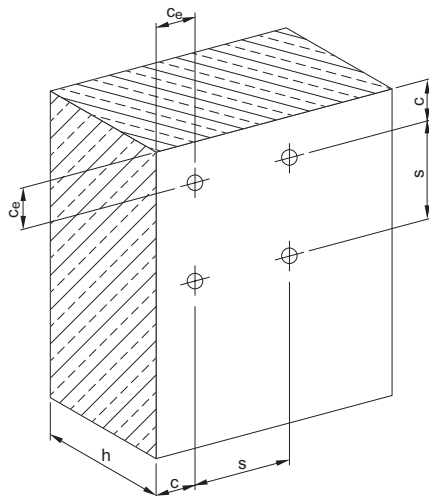

Application requirements

Thickness of base material

Concrete: **C12/15 to C35/45**

Corrosion information

The intended use comprises fastenings of thermal insulation composite systems which are subject to external atmospheric exposure.

During construction, exposure to UV due to solar radiation of the fixing element not protected by rendering shall not exceed the time of 6 weeks.

The temperature during installation of the fixing element shall not be less than 5 °C.

Fastener selection and system recommendation

Fastener program

Designation	Fastener	Item no.	Insulation thickness h_D [mm]
XI-FV 60	X-CPH 72	376484	60
XI-FV 80	X-CPH 72	376485	80
XI-FV 100	X-CPH 72	376489	100
XI-FV 120	X-CPH 72	376490	120
XI-FV 140	X-CPH 72	376491	140
XI-FV 160	X-CPH 72	2069160	160
XI-FV 180	X-CPH 72	2069161	180
XI-FV 200	X-CPH 72	2069162	200
HDT-FV 90	-	285628	-
HDT-FV 140	-	372907	-

Note:

For soft mineral wool use XI-FV with HDT-FV 90 and HDT-FV 140.

System recommendation

Tool

DX 460 IE, DX 460 IE XL, DX 5 IE, DX 5 IE XL

Cartridge selection and tool energy setting

Concrete **6.8/11M yellow, red or black** cartridge

See **Fastening quality assurance** for details.

Fastening quality assurance

Cartridge colour and tool energy selection

Example in case of uncoated concrete (Annex B4 of ETA-17/0304: By means of the control tests made to uncoated concrete, the cartridge colour and tool energy required for driving in XI-FV for achieving the mean anchorage depth, h_V , is determined. Please refer to XI-FV ETA approval for more details.

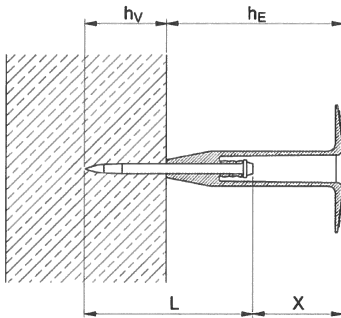

$$h_V = (L + X) - h_E = 30 \text{ mm}$$

where

h_V = mean anchorage depth

h_E = length of plastic part

L = length of powder actuated fastener

X = control dimension

Designation	Insulation thickness t_j [mm]	Control dimension X [mm]
XI-FV 60	60	≥ 12.5
XI-FV 80	80	≥ 32.5
XI-FV 100	100	≥ 52.5
XI-FV 120	120	≥ 72.5
XI-FV 140	140	≥ 92.5
XI-FV 160	160	≥ 112.5
XI-FV 180	180	≥ 132.5
XI-FV 200	200	≥ 152.5

These are abbreviated instructions which may vary by application.

ALWAYS review/follow the instructions accompanying the product.



X-SW 30, X-SW 60 Soft washer fastener

Product data

Dimensions

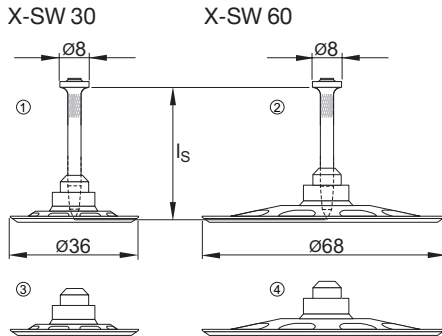

General information

Material specifications

Plate:	PE
Nail:	Carbon steel shank: HRC 52.5
	Zinc coating: 5–13 μm

Recommended fastening tools

DX 460, DX 460 MX, DX 5, DX 5 MX,
DX 36, DX 2, DX-E 72, GX 120 system,
GX 2 system, GX 3 system

See **X-SW fastener program** in the next pages and **Tools and equipment** chapter for more details.

Applications

Examples

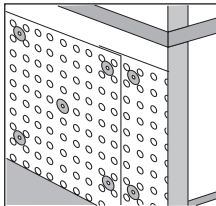

Membranes and drainage plates

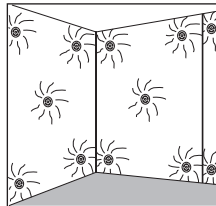

Insulation up to 30 mm thick

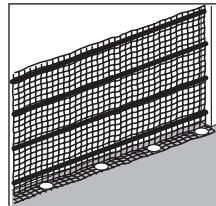

Nets, fabric and similar

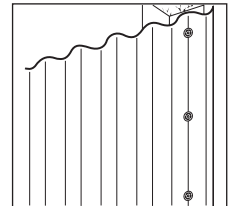

Plastic corrugated sheets

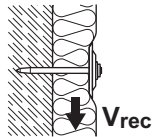
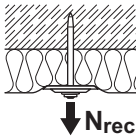
Load data
Recommended loads

Design conditions:

1. Minimum 5 fastenings per fastened unit.
2. Predominantly static loading.
3. Design loads valid for nail pull-out strength. Fastened material has to be considered separately.
4. Valid for concrete C 30/37.

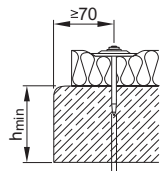
	Tension, N_{rec} [kN]	Shear, N_{rec} [kN]
DX	0.3	0.3
GX (with X-GN 39 MX, X-C 39 G2 MX, X-C 39 G3 MX)	0.1	0.1

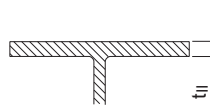
Application requirements
Thickness of base material
Concrete: $h_{min} = 80$ mm

Steel: $t_{II} \geq 4$ mm

 (Not recommended for X-GN 39 MX,
X-C 39 G2 MX, X-C 39 G3 MX)

Thickness of fastened material

 Membranes, nets, etc.: $t_I \leq 25$ mm (X-GN 39 MX, X-C 39 G2 MX, X-C 39 G3 MX)

 Insulation: $t_I \leq 30$ mm (Not recommended for
X-GN 39 MX, X-C 39 G2 MX, X-C 39 G3 MX)

Spacing and edge distances

For setting instructions please inquire at the supplier of fastened material.

Fastener selection and system recommendation

Fastening to concrete

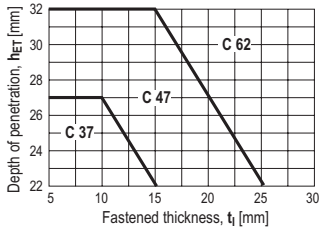

- **X-SW 30** for stronger, less damageable material.
- **X-SW 60** for more easily damaged material (i.e. aluminium foil, nets, paper, etc.)
- Select nail lengths (**C 37**, **C 47** and **C 62**) according to base material conditions and fastened thickness

Fastener program

Designation	Item no. Packs of 100/150	Packs of 400/500	L_s [mm]	Tools
				Designation
① X-SW 30-C 37	40643	40614	37	DX 460, DX 5, DX 36, DX 2, DX-E 72
① X-SW 30-C 47	40644	40615	47	DX 460, DX 5, DX 36, DX 2, DX-E 72
① X-SW 30-C 62	40645	40616	62	DX 460, DX 5, DX 36, DX 2, DX-E 72
② X-SW 60-C 37	40617		37	DX 460, DX 5, DX 36, DX 2, DX-E 72
② X-SW 60-C 47	40618		47	DX 460, DX 5, DX 36, DX 2, DX-E 72
② X-SW 60-C 62	40619		62	DX 460, DX 5, DX 36, DX 2, DX-E 72
③ X-SW 30	371370			DX 460-MX, DX 5 MX with collated
③ X-SW 60	371371			X-C nails (3.5 mm shank dia.)
				GX-120 with X-GN 39 MX nails
				GX 2 with X-C 39 G2 MX nails
				GX 3 with X-C 39 G2 MX nails

Cartridge selection and tool energy setting

Cartridge recommendation: Concrete **6.8/11M yellow or red**

Masonry: **6.8/11M green**

Tool energy adjustment by setting tests on site.

X-FS Form stop

Product data

Dimensions

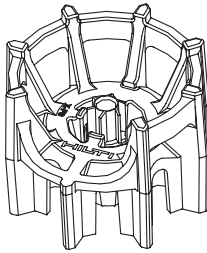
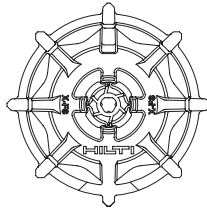
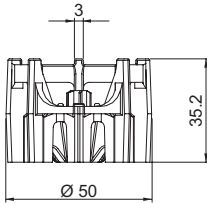

General information

Material specifications

Nail: zinc coating: 5–20 µm

Recommended fastening tools

DX 460, DX 460 MX, DX 5, DX 5 MX, DX 36, DX 2,

See **X-FS fastener program** in the next pages and **Tools and equipment** chapter for more details.

Applications

Examples

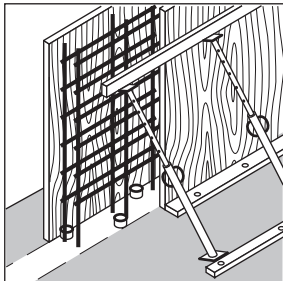

Positioning concrete forms on concrete surfaces. Leave in place, grey polyethylene is non rusting, nearly invisible and non-conductive.

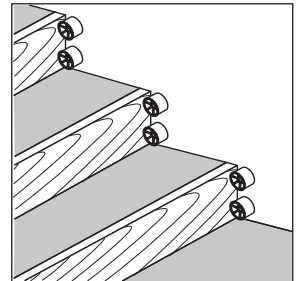
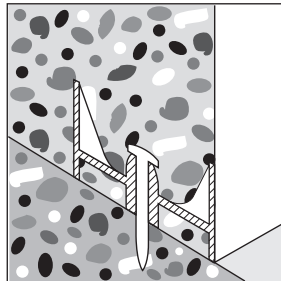

X-FS is suitable and usable for minor forming applications

Load data

Recommended working loads

$V_{rec} = 400 \text{ N}$

(predominantly static, however, vibration from concrete compacting is allowed)

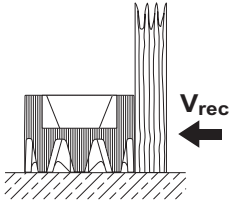

Application requirements

Thickness of base material

Concrete: $h_{min} = 80 \text{ mm}$

Spacing and edge distances

Spacing and edge distances depending on job site requirements.

Corrosion information

For temporary fixations no restrictions exist.

Fastener program

Fastener				Tools
Designation	Item no.	L_s [mm]	Nail shank diameter [mm]	Designation
① X-FS C 52 *	407346	52	3.5	DX 460, DX 5, DX 36, DX 2
② X-FS MX **	408022			DX 460-MX, DX 5 MX

* For unusual applications, **X-FS** available with other nails on special order

** **X-FS** without nail for fastening with collated nails.

Cartridge selection and tool energy setting

Cartridge recommendation:	Steel:	6.8/11M red cartridge
	Concrete:	6.8/11M yellow or red cartridge
	Masonry:	6.8/11M yellow or green cartridge

Tool energy adjustment by setting tests on site.

X-DFS Double form stop

Product data

Dimensions

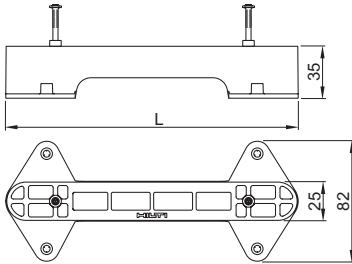

Features and benefits

- Fixed-length form stops for soft concrete base material
- Leave in place formwork spacer

General information

Material specifications

X-DFS: Polypropylene
(halogen and silicone free)
Grey (RAL 7030), green (RAL 6018), light brown (RAL 8001)

Nails (pre-mounted):

X-C 62 Carbon steel, HRC 56.5
($d_{nom} = 3.5mm$) zinc coating 5-20 μm

Recommended fastening tools

DX 5-F8, DX 2, DX 460-F8, DX 351 ME

Applications

Example

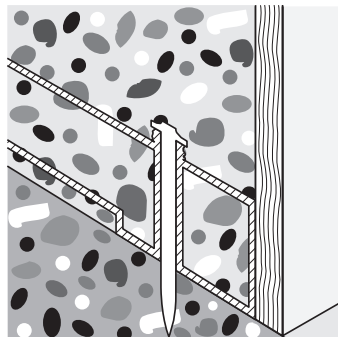
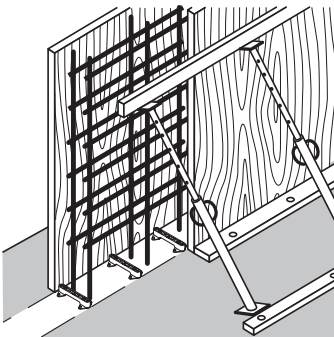

Positioning concrete forms on concrete surfaces. Leave in place, polypropylene is non rusting, nearly invisible and non-conductive.

Recommended loads (Base material = concrete)

Load data

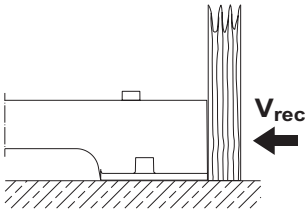

$$V_{\text{rec}} = 400 \text{ N}$$

(predominantly static, however, vibration from concrete compacting is allowed)

Valid for soft concrete with strength of $f_{c, \text{cube}} = 25\text{-}45 \text{ N/mm}^2$. For more details regarding concrete types, please refer to **Concrete Fastener Selection** section in Hilti Direct Fastening Technology Manual (DFTM).

Nail recommendations

For **concrete** base material

Nail type	Length [mm]	Tip	Shank Ø [mm]	Material	Hardness [HRC]	Coating
X-C 62	62	Cut	3.5	Carbon steel	56.5	Zinc, 5-20µm

- 2 no. of X-C 62 nails are pre-mounted to each X-DFS element.

Application requirements

Thickness of base material

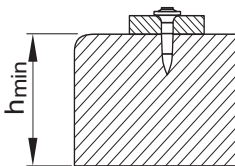

$$\text{Concrete: } h_{\text{min}} = 80 \text{ mm}$$

Spacing and edge distance

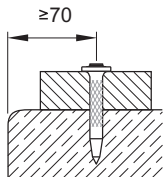

$$c \geq 70 \text{ mm}$$

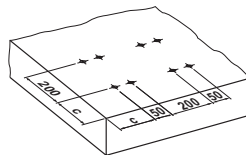

Corrosion information

For temporary fixations no restrictions exist.

Fastener selection and system recommendation

Fastener program

Designation	Item no.	L [mm]	Nail shank Ø d _{nom} [mm]	Colour	Tool Designation
X-DFS 160 C62	2159751	160	3.5	Grey	DX 5-F8, DX 2,
X-DFS 180 C62	2159752	180	3.5	Green	DX 460-F8,
X-DFS 200 C62	2159753	200	3.5	Light brown	DX 351 ME

Cartridge selection

Concrete: 6.8/11 M10 green or yellow cartridge

Tool energy adjustment by setting tests on site.

X-DFC Double fire clip

Product data

Dimensions

X-DFC 8 MX / X-DFC-W 8 MX

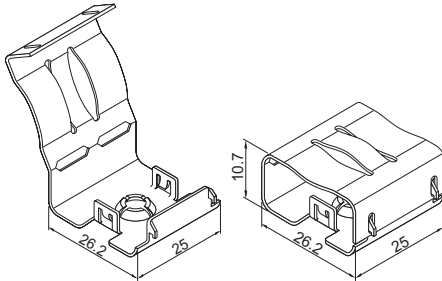

X-DFC 9 MX / X-DFC-W 9 MX

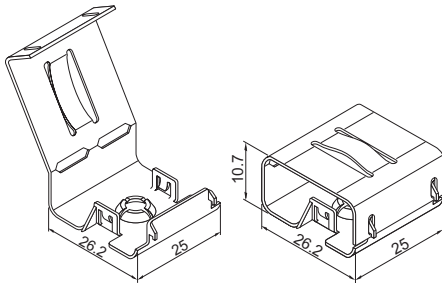

Features and benefits

- Easy and convenient installation to concrete (soft and some tough) and sandlime stone base material
- Quick, cost-efficient fastening
- Can be clicked on BX fastener guide, no adaptor needed
- Tested by an external, certified test institute

General information

Material specifications

X-DFC-MX: Stainless steel with 50 µm
red or white colour coating

Approval and standards

Product qualification according to BS EN 50200,
BS EN 50200 Annex E and BS 8434-2

In compliance with cable support requirements of
BS 5839-1, BS 5839-8 and BS 5266-1

Applications

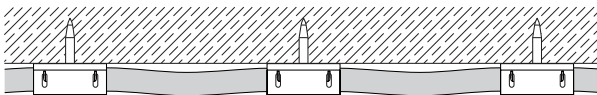

Installation of fire alarm and emergency lighting cables.

Performance data

Fire rating

Cable	Fastener	Cable size	Classification	Test standard
Prysmian FP200 Gold (standard)	X-DFC 8 MX / X-DFC-W 8 MX	2 core x 1.5 mm ² 3 core x 1.5 mm ²	PH 60	BS EN 50200 (dry)
			PH 30	BS EN 50200 Annex E (wet)
Prysmian FP plus (enhanced)	X-DFC 9 MX / X-DFC-W 9 MX	2 core x 1.5 mm ²	PH 120	BS EN 50200 (dry) BS 8434-2 (wet)
Ventcroft NoBurn Platinum (standard)	X-DFC 8 MX / X-DFC-W 8 MX	2 core x 1.5 mm ² 4 core x 1.0 mm ²	PH 60	BS EN 50200 (dry)
			PH 30	BS EN 50200 Annex E (wet)
	X-DFC 9 MX / X-DFC-W 9 MX	2 core x 2.5 mm ² 4 core x 1.5 mm ²	PH 60	BS EN 50200 (dry)
			PH 30	BS EN 50200 Annex E (wet)
Ventcroft NoBurn plus (enhanced)	X-DFC 8 MX / X-DFC-W 8 MX	2 core x 1.5 mm ²	PH 120	BS EN 50200 (dry) BS 8434-2 (wet)

Conditions:

- Pre-loading of the elements after setting
- All visible failures must be replaced.
- Observance of all application limitations and recommendations.

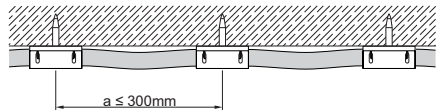

Recommended fastener spacing a:
horizontal ≤ 300 mm, vertical ≤ 400 mm

Fastener selection and system recommendation

Fastener program

Designation	Item no.	Colour	Cable diameter
X-DFC 8 MX	2143695	Red	8 mm $\leq D \leq 8.5$ mm
X-DF-W 8 MX	2143699	White	
X-DFC 9 MX	2143696	Red	8.5 mm $\leq D \leq 9$ mm
X-DFC-W 9 MX	2143730	White	

Tool selection

- | | | |
|------------|---------|--------------------------------|
| X-P B3 MX: | BX 3-ME | No gas can required |
| X-P G3 MX: | GX 3-ME | Gas can GC 40, GC 41 and GC 42 |

Nail recommendation

Fastening tool	Nail types	Length [mm]	Tip	Shank Ø [mm]	Material	Hardness [HRC]	Coating [µm]
BX3-ME	X-P B3 MX	17 - 20	Long-conical	3.0	Carbon steel	57.5	Zinc, 2-13
GX3-ME	X-P G3 MX					57.5	Zinc, 2-13

- For the X-DFC MX element, only 17 mm and 20 mm pin lengths are recommended in order to ensure sufficient embedment depth.
- Nails (as listed above) are recommended for wall and ceiling application (soft and some tough concrete and sandlime stone, GX/BX tools). For more details regarding nail classification and concrete types, see Concrete Fastener Selection chapter in Direct Fastening Technology Manual (DFTM).

Application requirements

Thickness of base material

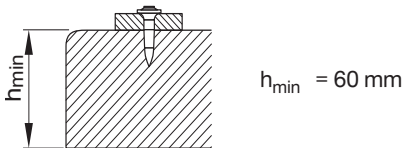

Edge distance

Min. edge distance = 70 mm

Corrosion information

Zinc-coated nails are not suitable for long-term service outdoors or in otherwise corrosive environments. For further detailed information on corrosion see relevant chapter in Direct Fastening Principles and Technique section.

Fastening quality assurance

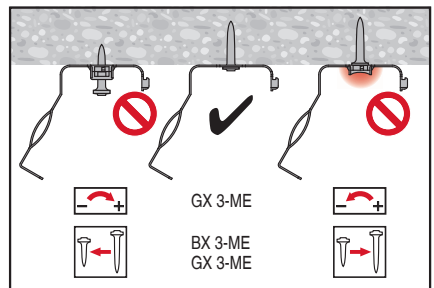
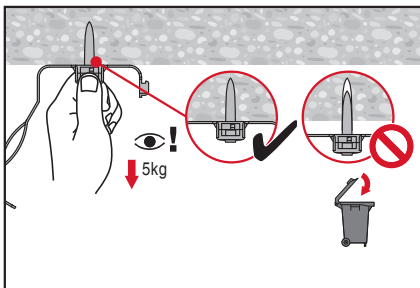

X-EGN, X-GHP, X-GN Fastener for gas-actuated tool

Product data

Dimensions

X-EGN 14

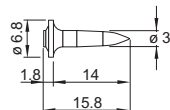

X-GHP 17/20/24

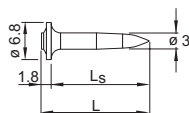

X-GN 20/27/32

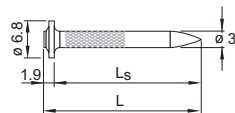

X-GN 39

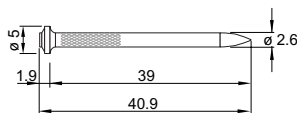

General information

Material specifications

Carbon steel shank:	X-EGN	HRC 57.5
	X-GHP	HRC 57.5
	X-GN	HRC 53.5
Zinc coating:	2–13 µm	

Recommended fastening tools

GX 120, GX 120-ME

GX 100, GX 100 E

See X-EGN, X-GHP, X-GN fastener program in the next pages and Tools and equipment chapter for more details.

Approvals

ICC-ESR 1752 (USA):	X-GN 20/27/32, X-EGN 14, X-GHP 16/17/20/24 X-GHP, X-GN
IBMB	X-GHP, X-GN

Note: technical data presented in these approvals and design guidelines reflect specific local conditions and may differ from those published in this handbook.

Applications

Examples

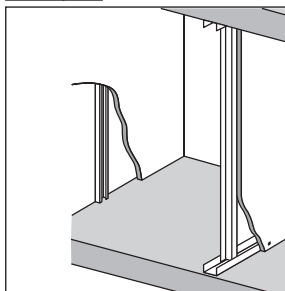

Drywall tracks to concrete and steel



Electrical applications

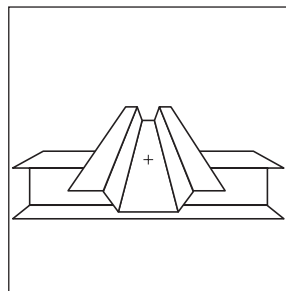

Temporary tacking of composite deck to steel beams

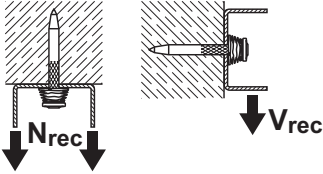
Performance data
Performance data for drywall track fastening

X-EGN (Base material: steel)

Tension N_{rec} [kN]	Shear V_{rec} [kN]
0.4	0.4

X-GHP, X-GN (Base material: concrete / sand-lime masonry)

Embedment [mm]	Recommended Loads [kN]					
	Tension N_{rec}		Shear V_{rec}		Tension N_{rec}	Shear V_{rec}
	Concrete Type				Sand-lime masonry	
	Soft	Tough	Soft	Tough		
≥ 22	-	-	-	-	0.3	0.3
≥ 18	0.2	-	0.2	-	0.2	0.2
≥ 14	0.1	0.1	0.1	0.1	0.1	0.1

Conditions:

- For safety relevant fastenings sufficient redundancy of the entire system is required; Minimum of 5 nails per fastened track. All visible setting failures must be replaced
- Sheet metal failure is not considered in recommended loads and must be assessed separately
- Soft concrete up to $f_{c,cube} = 45 \text{ N/mm}^2$ (C35/45), some tough concrete up to $f_{c,cube} = 60 \text{ N/mm}^2$ (C50/60).
- Concrete with aggregate like granite or river rock or softer, and up to 16 mm diameter

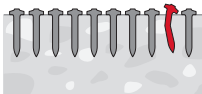

	Stick rate estimation	
	Soft Concrete	Tough concrete
X-GHP	85% - 98%	70% - 85%
X-GN	75% - 90%	55% - 70%

- The stick rate indicates the percentage of nails that were driven correctly to carry a load. Stick rate can vary from the above values depending on job site conditions.

Recommended loads of X-EGN 14 MX for temporary tacking of composite decks

Tension N_{rec} [kN]	Shear N_{rec} [kN]
0.4	0.4

Conditions:

- The intended use of the fastenings is to secure the deck position and to ensure a safe working platform during the erection state only. The fasteners serve as temporary fixation until the shear connectors of the composite beams are attached.
- At each permanent composite deck support, it is recommended to drive at least one fastener per trough.
- Every deck panel must be fixed at least with two fasteners at every permanent support.
- Single layer sheet with a maximum thickness of 1.25 mm.
- Sheeting grade up to S450 acc. to EN 10346.
- Minimum base material thickness: 6 mm.
- Minimum steel grade: S235 acc. to EN 10025-2.

Application requirements

Thickness of base material

Concrete

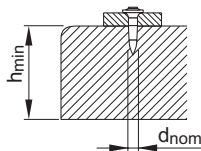

$h_{min} = 60 \text{ mm}$
 $(d_{nom} = 3.0 \text{ mm})$

Steel

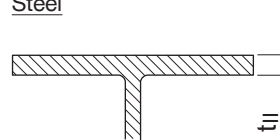

$t_{II} \geq 4 \text{ mm}$

Thickness of fastened material

Wooden track: $t_I \leq 25 \text{ mm}$
 Metal track: $t_I \leq 2 \text{ mm}$

Spacing and edge distances (mm)

Spacing along track
(as per U.S. Gypsum Handbook)

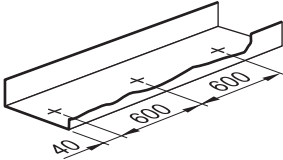

All track ends (cut-outs for doors),
secure with 2 nails

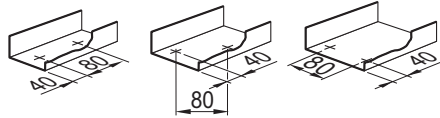

Distance to edge of concrete / Fastener spacings on wood:
sandlime masonry

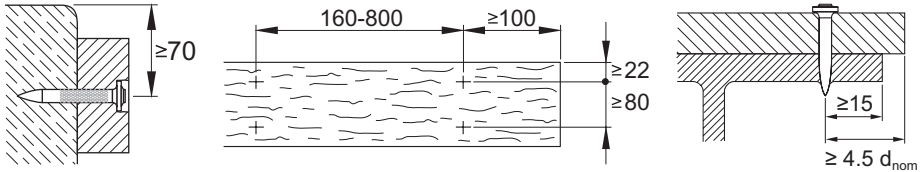
Corrosion information

The intended use only comprises fastenings which are not directly exposed to external weather conditions or moist atmospheres. For further detailed information on corrosion see relevant chapter in **Direct Fastening Principles and Technique** section.

Application limits

Steel

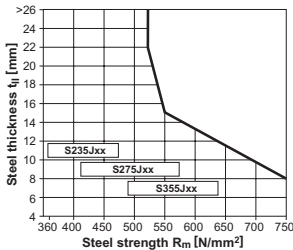

For temporary tacking of composite decks

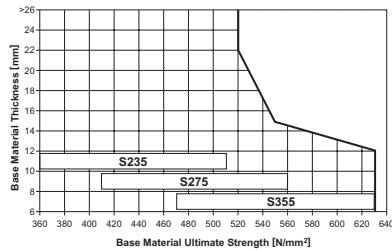

X-EGN 14

Design conditions:

- Single layer sheet with a maximum thickness of 1.25 mm.
- Sheeting grade up to S450 acc. to EN 10346.
- Minimum base material thickness: 6 mm
- Minimum steel grade: S235 acc. to EN 10025-2

Fastener selection and system recommendation

Fastener selection

Fastening to concrete / sandlime masonry

	Application	Base material	
X-GN 39 MX	Wooden track ($t_1 \leq 25$ mm)	Concrete/sandlime masonry	increasing strength
X-GN 27MX	Metal track	Concrete/sandlime masonry	
X-GN 20 MX	Metal track	Concrete/sandlime masonry	
X-GHP_MX	Metal track	Concrete/sandlime masonry	

Fastening to steel

	Application	Base material	
X-EGN 14	Metal track	Steel	

Fastener program

	Item no.	L_s [mm]	L [mm]	d_{nom} [mm]
X-EGN 14 MX	340231	14	15.8	3.0
X-GHP 16 MX	2071471	16	17.8	3.0
X-GHP 17 MX	340228	18	19.8	3.0
X-GHP 20 MX	285724	20	21.8	3.0
X-GHP 24 MX	438945	24	25.8	3.0
X-GN 20 MX	340232	19	20.9	3.0
X-GN 27 MX	340230	27	28.9	3.0
X-GN 32 MX	340233	32	33.9	3.0
X-GN 39 MX	340234	39	40.9	2.6

Tool and gas can
Designation
GX 120 / GX 120 ME

with gas can GC 20, GC 21 and GC 22

GX 100 / GX 100 E

with gas can GC 11 and GC 12 (for USA)

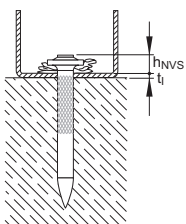
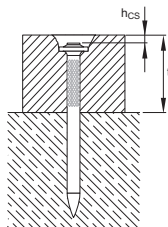
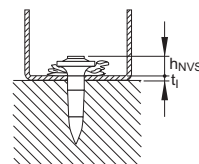
Fastening quality assurance
Fastening inspection
Fastening to concrete / sandlime masonry

X-GN/GHP: $h_{NVS} = 2-5$ mm

X-GN 39: $h_{CS} = 2-3$ mm
Fastening to steel

X-EGN 14: $h_{NVS} = 2-9$ mm

GX 3 System Fastener for interior finishing, building construction, mechanical and electrical application

Product data

GX 3 gas tool



GX 3, GX 3-ME

Nails (For fastening to concrete)

X-P 17/20/24 G3 MX

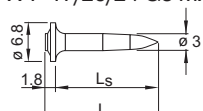

X-C 20/27/32 G3 MX

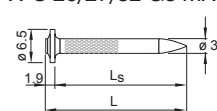

X-C 39 G3 MX

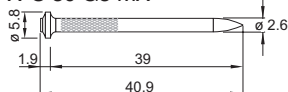

Nails (For fastening to steel)

X-S 14 G3 MX

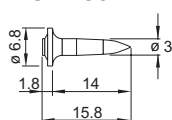

General information

Material specifications: B3 threaded studs

X-P G3 MX, X-S G3 MX

Carbon steel, HRC 57.5, 2-13 µm zinc coating

X-C G3 MX

Carbon steel, HRC 56.5, 2-13 µm zinc coating

Approvals

ICC-ESR 1752 (USA)

X-P 17/20/24 G3 MX, X-C 20/27/32 G3 MX and X-S 14 G3 MX

IBMB

X-P 17/20/24 G3 MX, X-C 20/27/32/39 G3 MX

ETA-16/0301

X-P 20/24 G3 MX

Applications

Examples



Drywall tracks



Light-duty building construction applications

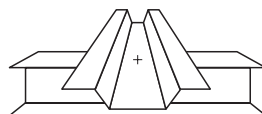

Temporary tacking of composite deck to steel beams

Product data

Electrical elements to be used with nails

X-ECT MX



X-UCT MX



X-EKS MX

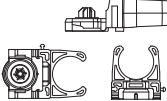

X-EKSC MX



X-FB MX



X-ECH MX



X-DFB MX



X-EKB MX



X-ECC MX



X-EHS MX



X-ET MX

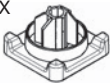

X-TT



X-ECT 40 MX



General information

Material specifications

X-ECT MX, X-EKS MX, X-EKSC MX, Polyamide (halogen and silicone free), light grey RAL 7035
X-EKB MX, X-ECH MX

X-ECT-FR MX, X-EKB-FR MX

PBT (silicone free, flame retardant), stone grey RAL 7030

X-UCT MX, X-ET MX

HDPE (halogen and silicone free), light grey RAL 7035

X-TT

Polyester (PES)

X-FB MX, X-DFB MX

Galvanized steel sheet, $f_U = 270-420 \text{ N/mm}^2$, 10-20 μm zinc coating

X-ECC MX, X-EHS MX

Galvanized steel sheet, $f_U = 270-420 \text{ N/mm}^2$, $\geq 10-20 \mu\text{m}$ zinc coating

Approvals

ICC-ESR 1752 (USA), IBMB, ETA-16/0301

Applications



Conduits and light-duty pipes



Electrical cables

Product data

GX 3 gas tool



GX 3, GX 3-ME

Studs

(For fastening to concrete)

X-M6-7-24 G3 P7

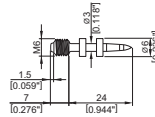

X-W6-12-20 G3 P7

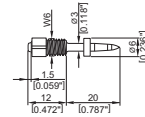

(For fastening to steel)

X-M6-7-14 G3 P7

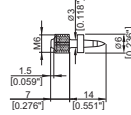

X-W6-12-14 G3 P7

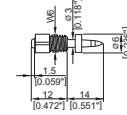

General information

Material specifications

Carbon steel shank

HRC 57.5

Zinc coating

2-10 μm

Applications



Junction boxes, switch boxes, etc.

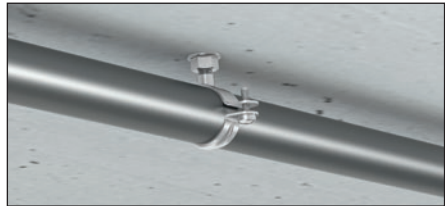

Pipe rings for light-duty pipes

Performance data

Performance data for drywall track fastening

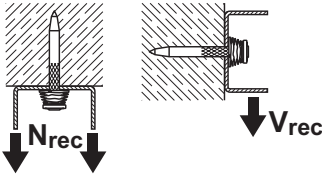

X-S 14 G3 MX (Base material: steel)

Tension N_{rec} [kN]	Shear V_{rec} [kN]
0.4	0.4

X-P G3, X-C G3 (Base material: concrete / sand-lime masonry)

Embedment [mm]	Recommended Loads [kN]					
	Tension N_{rec}		Shear V_{rec}		Tension N_{rec}	Shear V_{rec}
	Concrete Type				Sand-lime masonry	
	Soft	Tough	Soft	Tough		
≥ 22	-	-	-	-	0.3	0.3
≥ 18	0.2	-	0.2	-	0.2	0.2
≥ 14	0.1	0.1	0.1	0.1	0.1	0.1

Conditions:

- For safety relevant fastenings sufficient redundancy of the entire system is required; Minimum of 5 nails per fastened track. All visible setting failures must be replaced
- Sheet metal failure is not considered in recommended loads and must be assessed separately
- Soft concrete up to $f_{c,cube} = 45 \text{ N/mm}^2$ (C35/45), some tough concrete up to $f_{c,cube} = 60 \text{ N/mm}^2$ (C50/60).
- Concrete with aggregate like granite or river rock or softer, and up to 16 mm diameter

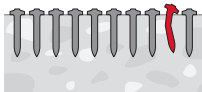

	Stick rate estimation	
	Soft Concrete	Tough concrete
X-P G3	85% - 98%	70% - 85%
X-C G3	75% - 90%	55% - 70%

- The stick rate indicates the percentage of nails that were driven correctly to carry a load. Stick rate can vary from the above values depending on job site conditions.

Threaded stud	Recommended loads and tightening torque			Base material
	N_{rec} [kN]	V_{rec} [kN]	T_{rec} [Nm]	
X-M6-7-24 G3 P7	0.05	0.05	3.0	Concrete, sand-lime masonry
X-W6-12-20 G3 P7				
X-M6-7-14 G3 P7	0.2	0.2	3.0	Steel
X-W6-12-14 G3 P7				

Recommended loads (electrical elements used with nails)

Element	Maximum service load F_{max} [N]
X-ECT (FR) MX	40
X-UCT MX	40
X-EKS MX	11
X-EKSC MX	32
X-FB MX / X-DFB MX	20
X-ECC MX	50
X-EHS MX	80
X-EKB (FR) 4 MX	9
X-EKB (FR) 8 MX	14
X-EKB (FR) 16 MX	18
X-ECH MX	40
	Cable trunking
X-ET MX	100

Application requirements

Thickness of base material

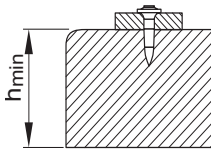

Concrete (for nails and threaded studs)
 $h_{\min} = 60 \text{ mm}$

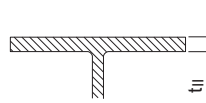

Steel
 $t_{II} \geq 4.0 \text{ mm}$ (for nails)
 $t_{II} \geq 6.0 \text{ mm}$ (for threaded studs)

Thickness of fastened material

Wooden track: $t_I \leq 25 \text{ mm}$

Metal track: $t_I \leq 2 \text{ mm}$

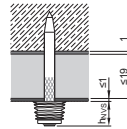

Deflection head:
 $t_{l,\text{tot.}} \leq 21 \text{ mm}$ (gypsum strip + metal track and sealant)

Spacing and edge distances (mm)

Spacing along track

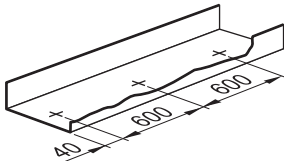

All track ends (cut-outs for doors),
 secure with 2 nails

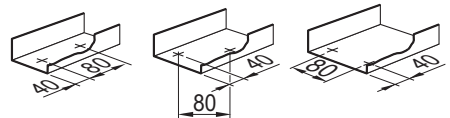

Fastener spacing max. 30 cm for proprietary light non-load-bearing partition walls with fire classification

Distance to edge of concrete / sand-lime masonry

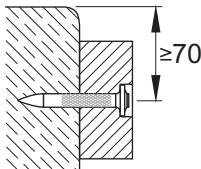

Spacing between nails when fastening wood to concrete

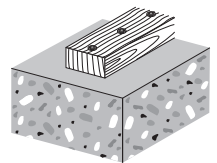
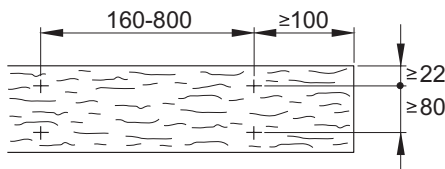

Distance to edge of fastened material (steel base material)

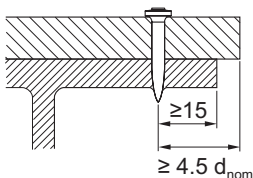

Application limits

X-S 14 G3 MX

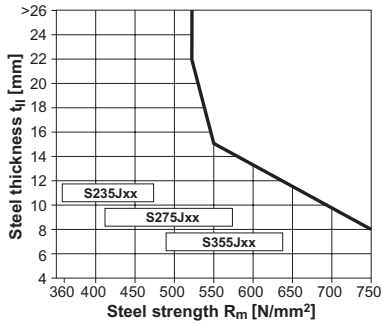

X-M6-7-14 G3 P7, X-W6-12-14 G3 P7

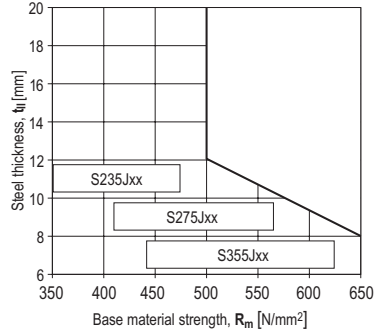

For temporary tacking of composite decks

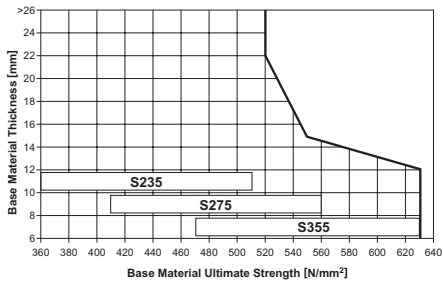

Design conditions:

- Single layer sheet with a maximum thickness of 1.25 mm.
- Sheeting grade up to S450 acc. to EN 10346.
- Minimum base material thickness: 6 mm
- Minimum steel grade: S235 acc. to EN 10025-2

Corrosion information

The intended use only comprises fastenings which are not directly exposed to external weather conditions or moist atmospheres, i.e. only intended for dry indoor areas.

Fastener selection and system recommendation

Fastener program









Nails

Nail	Item no.	Shank length (mm)	Shank diameter (mm)	Base material	Length recommendation
X-S 14 G3 MX	2101547	14	3	Steel	
X-P 17 G3 MX	2101046	17	3	Concrete / Sand-lime masonry	
X-P 20 G3 MX	2101047	20	3		
X-P 24 G3 MX	2101048	24	3		
X-C 20 G3 MX	2100955	20	3		
X-C 27 G3 MX	2100956	27	3		
X-C 32 G3 MX	2100957	32	3		
X-C 39 G3 MX	2100958	39	2.8		

Threaded studs

Threaded studs	Item no.	Thread size	Thread length (mm)	Shank length (mm)	Shank diameter (mm)	Base material
X-M6-7-14 G3 P7	2101052	M6	7	14	3	Steel
X-M6-7-24 G3 P7	2101053	M6	7	24	3	Concrete
X-W6-12-14 G3 P7	2101054	W6	12	14	3	Steel
X-W6-12-20 G3 P7	2101055	W6	12	20	3	Concrete

Fastener recommendations

	Nail Selector for GX 3			
	Hollow brick	Concrete		Steel
		Wall / Floor	Ceiling	
	X-C 27 G3 MX X-C 20 G3 MX	X-C 20 G3 MX	X-C 20 G3 MX X-P 17 G3 MX	X-S 14 G3 MX
	X-C 39 G3 MX X-C 32 G3 MX			
	X-C 27 G3 MX X-C 20 G3 MX	X-C 20 G3 MX	X-C 20 G3 MX X-P 17 G3 MX	X-S 14 G3 MX
	X-C 20 G3 MX		X-C 20 G3 MX X-P 17 G3 MX	X-S 14 G3 MX
	X-C 20 G3 MX		X-C 20 G3 MX X-P 17 G3 MX	X-S 14 G3 MX
	X-W6-12-20 G3 P7 X-M6-7-24 G3 P7			X-W6-12-14 G3 P7 X-M6-7-14 G3 P7
Gas can		GC 40 / GC 41 / GC 42 - For all base materials		

For more details and information, please contact your nearest Hilti representative.

Fastener guide	Item no.	Use
X-FG G3	2102280	With nails or studs only
X-FG G3-ME	2102281	With nails + elements or only studs

Fastening quality assurance

Fastening inspection

Nails and studs in concrete / sand-lime masonry

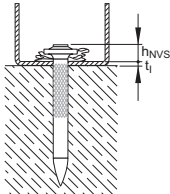

X-P_G3 MX, X-C_G3 MX:
 $h_{NVS} = 2-5 \text{ mm}$

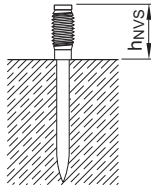

X-M6-7-24 G3 P7
 X-W6-12-20 G3 P7

$h_{NVS} \geq 7 \text{ mm}$
 $\geq 12 \text{ mm}$

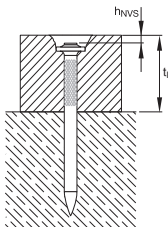

X-P_G3 MX, X-C_G3 MX:
 $h_{NVS} = 2-3 \text{ mm}$

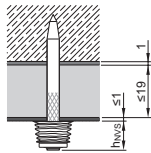

Deflection head
 X-C 39 G3 MX
 12.5 mm board: $h_{NVS} \leq 15 \text{ mm}$
 15 mm board: $h_{NVS} \leq 12 \text{ mm}$
 19 mm board: $h_{NVS} \leq 8 \text{ mm}$

Nails and studs in steel

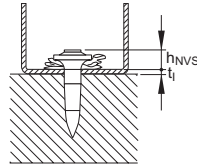

X-S 14 G3 MX:
 $h_{NVS} = 2-9 \text{ mm}$

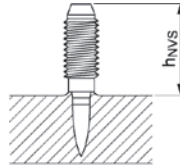

X-M6-7-14 G3 P7
 X-W6-12-14 G3 P7
 $h_{NVS} \geq 7 \text{ mm}$
 $\geq 12 \text{ mm}$

Element	h_{NVS} (mm)	
	Concrete	Steel
X-EKB 4/8 MX	6-11	6-9
X-EKB 16 MX	6-11	6-9
X-ECT MX	6-11	6-9
X-UCT MX	6-11	6-9
X-ECH MX	6-11	6-9
X-EKS MX	6-11	6-9
X-EKSC MX	6-11	6-9
X-FB MX	7-11	7-9
X-DFB MX	7-11	7-9
X-ECC MX	7-11	7-9
X-EHS MX	7-11	7-9
X-ET MX*	5-10	5-9

*) With X-ET MX, the h_{NVS} is measured against the cable trunk.

Examples

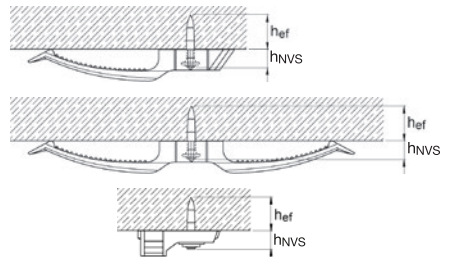



GX 2 System Fastener for interior finishing application

Product data

Dimensions

X-P 14 G2 MX

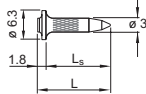

X-P 17 / 20 G2 MX

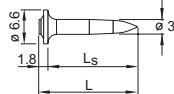

X-C 20 / 27 / 32 G2 MX

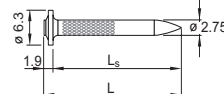

X-C 39 G2 MX

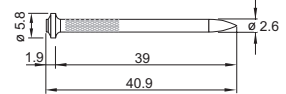

General information

Material specifications

Carbon steel shank:	X-P G2	HRC 57.5
	X-C G2	HRC 56.5
Zinc coating:		2-13 µm
	(X-P 14 G2 MX)	up to 16 µm

Recommended fastening tool

GX 2



Approvals

ICC ESR-1752 (USA): **X-C 20 / 27 / 32 G2, X-P 14 / 17 / 20 G2**

Applications

Examples



Drywall tracks



Light-duty applications in construction

Performance data

Performance data for drywall track fastening

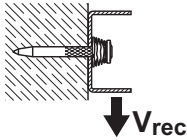

X-P 14 G2 MX (Base material: steel)

Tension N_{rec} [kN]	Shear V_{rec} [kN]
0.4	0.4

X-P G2, X-C G2 (Base material: concrete / sand-lime masonry)

Embedment [mm]	Recommended Loads [kN]					
	Tension N_{rec}		Shear V_{rec}		Tension N_{rec}	Shear V_{rec}
	Concrete Type				Sand-lime masonry	
	Soft	Tough	Soft	Tough		
≥ 22	-	-	-	-	0.3	0.3
≥ 18	0.2	-	0.2	-	0.2	0.2
≥ 14	0.1	0.1	0.1	0.1	0.1	0.1

Conditions:

- For safety relevant fastenings sufficient redundancy of the entire system is required; Minimum of 5 nails per fastened track. All visible setting failures must be replaced
- Sheet metal failure is not considered in recommended loads and must be assessed separately
- Soft concrete up to $f_{c,cube} = 45 \text{ N/mm}^2$ (C35/45), some tough concrete up to $f_{c,cube} = 60 \text{ N/mm}^2$ (C50/60).
- Concrete with aggregate like granite or river rock or softer, and up to 16 mm diameter

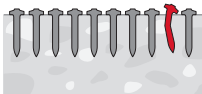

	Stick rate estimation	
	Soft Concrete	Tough concrete
X-P G2	85% - 98%	70% - 85%
X-C G2	75% - 90%	55% - 70%

- The stick rate indicates the percentage of nails that were driven correctly to carry a load. Stick rate can vary from the above values depending on job site conditions.

Application requirements

Thickness of base material

Concrete

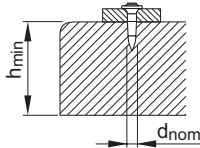

$h_{min} = 60 \text{ mm}$
 $(d_{nom} \leq 3.0 \text{ mm})$

Steel

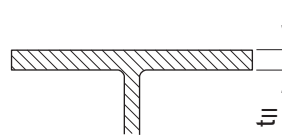

$t_{II} \geq 4.0 \text{ mm}$ (for nail)

Thickness of fastened material

Wooden track: $t_1 \leq 25 \text{ mm}$

Metal track: $t_1 \leq 2 \text{ mm}$

Spacing and edge distances (mm)

Spacing along track

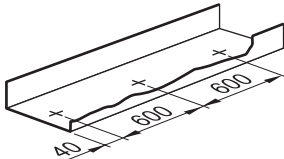

All track ends (cut-outs for doors),
 secure with 2 nails

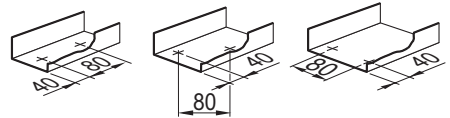

Edge distance for
 concrete/sand-lime masonry

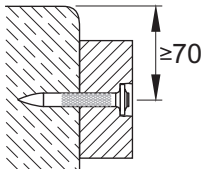

Fastener spacing on wood:

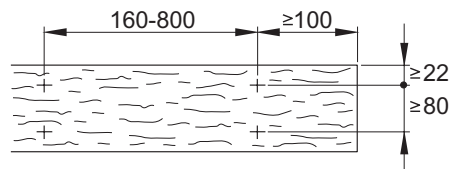

Edge distance for steel

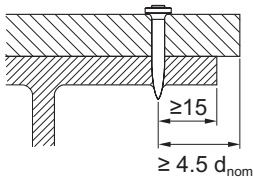

Corrosion information

The intended use only comprises fastenings which are not directly exposed to external weather conditions or moist atmospheres. For further detailed information on corrosion see relevant chapter in **Direct Fastening Principles and Technique** section.

Application limits

Steel

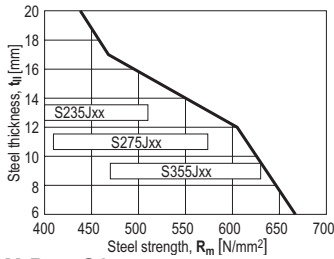

X-P 14 G2

Fastener selection

	Nail Selector for GX 2			
	Brick	Concrete Wall / Floor Ceiling	Steel	
	X-C 27 G2 MX X-C 20 G2 MX	X-C 20 G2 MX	X-C 20 G2 MX X-P 17 G2 MX	X-P 14 G2 MX
	X-C 39 G2 MX X-C 32 G2 MX			
Gas can				GC 52 - For all base materials

Fastening quality assurance

Nails in concrete / sand-lime masonry

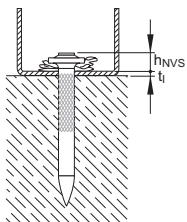

X-C / X-P G2 MX:
 $h_{NVS} = 2 - 5 \text{ mm}$

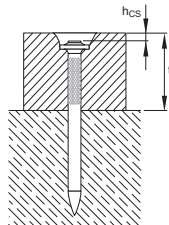

**X-C 39 G2 MX and
 X-C 32 G2 MX:**
 $h_{CS} = 2 - 3 \text{ mm}$

Nails in steel

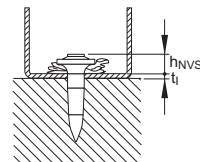

X-P 14 G2 MX:
 $h_{NVS} = 2 - 9 \text{ mm}$

BX 3 System Fastener for interior finishing, building construction, mechanical and electrical application

Product data

BX 3 battery-actuated direct fastening tools



BX 3-ME (02)
BX 3-IF



BX 3 02
BX 3-L 02

Features and benefits

- Hilti's combustion-free direct fastening technology for driving nails into concrete, steel and some types of solid masonry
- High user comfort thanks to low levels of compression force, noise and recoil
- No disposal of (used) propellant cartridges or gas cans
- Hilti's 22V cordless tool battery platform

Fasteners and their compatibility

Nails

For fastening to concrete

- X-P 17/20/24 B3 MX
- X-P 30/36 B3 P7
- X-C 20/24/27/30 B3 MX

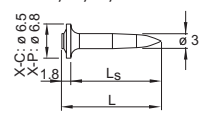

X-C 36 B3 MX

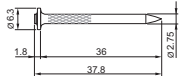

For fastening to steel

- X-S 14 B3 MX

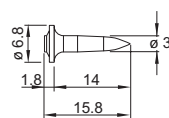

Threaded studs

For fastening to concrete

- X-M6-7-24 B3 P7

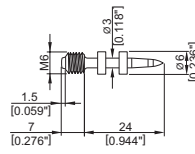

X-W6-12-20 B3 P7

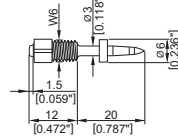

For fastening to steel

- X-M6-7-14 B3 P7

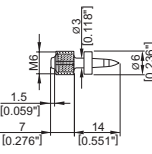

X-W6-12-14 B3 P7

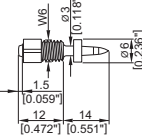

	BX 3-ME (02)	BX 3-IF	BX 3 02	BX 3-L 02
X-S 14 B3 MX	yes	yes	yes	yes
X-P 17 B3 MX	yes	yes	yes	yes
X-P 20 B3 MX	yes	yes	yes	yes
X-P 24 B3 MX	yes	yes	yes	yes
X-C 20 B3 MX	yes	yes	yes	yes
X-C 24 B3 MX	yes	yes	yes	yes
X-C 27 B3 MX	no	no	yes	yes
X-C 30 B3 MX	no	no	yes	yes
X-C 36 B3 MX	no	no	no	yes
X-M/W _ _ _ B3 P7	yes	yes	no	no
X-P _ B3 P7	yes	yes	no	no
ME MX elements	yes	with ME FG	with ME FG	with ME FG

General information

Material specifications

- X-P B3 MX/P7, X-S B3 MX
- X-C B3 MX

Carbon steel, HRC 57.5, 2-13 µm zinc coating
Carbon steel, HRC 56.5, 2-13 µm zinc coating

Electrical elements to be used with nails - examples

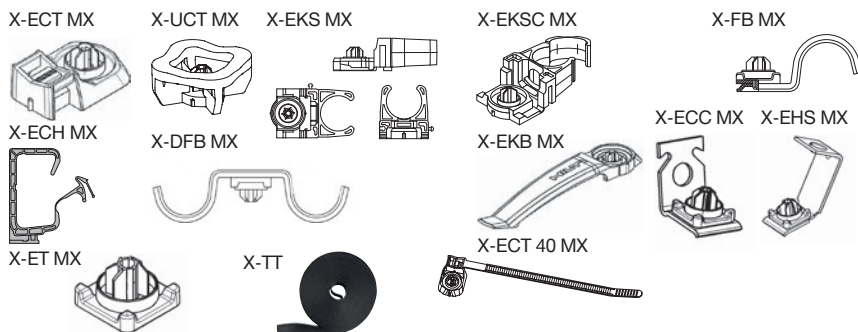

General information

Material specifications

X-ECT MX, X-EKS MX, X-EKSC MX,
X-EKB MX, X-ECH MX

X-ECT-FR MX, X-EKB-FR MX

X-UCT MX, X-ET MX

X-TT

X-FB MX, X-DFB MX

X-ECC MX, X-EHS MX

Polyamide (halogen and silicone free), light grey RAL 7035

PBT (silicone free, flame retardant), stone grey RAL 7030

HDPE (halogen and silicone free), light grey RAL 7035

Polyester (PES)

Galvanized steel sheet, $f_{tj} = 270-420 \text{ N/mm}^2$, 10-20 μm zinc coating

Galvanized steel sheet, $f_{tj} = 270-420 \text{ N/mm}^2$, $\geq 10-20 \mu\text{m}$ zinc coating

Approvals

ICC-ESR 1752 (USA)
ETA-16/0301

X-P 20 B3 MX, X-P 24 B3 MX, various electrical elements (see ETA approval Annex A1)

Applications

With nails



Drywall tracks to concrete and steel



Fastening wood, e.g. Placopan®, to concrete



Junction boxes, switch boxes, etc

With nails and elements



Flexible or rigid cable conduits with cable ties



Fastening cables



Cable conduits or light-duty pipes

Performance data

Performance data for drywall track fastening

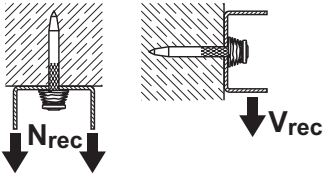

X-S 14 B3 MX (Base material: steel)

Tension N_{rec} [kN]	Shear V_{rec} [kN]
0.4	0.4

X-P B3, X-C B3 (Base material: concrete / sand-lime masonry)

Embedment [mm]	Recommended Loads [kN]					
	Tension N_{rec}		Shear V_{rec}		Tension N_{rec}	Shear V_{rec}
	Concrete Type				Sand-lime masonry	
	Soft	Tough	Soft	Tough		
≥ 22	-	-	-	-	0.3	0.3
≥ 18	0.2	-	0.2	-	0.2	0.2
≥ 14	0.1	0.1	0.1	0.1	0.1	0.1

Conditions:

- For safety relevant fastenings sufficient redundancy of the entire system is required; Minimum of 5 nails per fastened track. All visible setting failures must be replaced
- Sheet metal failure is not considered in recommended loads and must be assessed separately
- Soft concrete up to $f_{c,cube} = 45 \text{ N/mm}^2$ (C35/45), some tough concrete up to $f_{c,cube} = 60 \text{ N/mm}^2$ (C50/60).
- Concrete with aggregate like granite or river rock or softer, and up to 16 mm diameter



	Stick rate estimation	
	Soft Concrete	Tough concrete
X-P B3	85% - 98%	70% - 85%
X-C B3	75% - 90%	55% - 70%

- The stick rate indicates the percentage of nails that were driven correctly to carry a load. Stick rate can vary from the above values depending on job site conditions.

Performance data
Recommended loads (Threaded studs only)

Threaded stud	Recommended loads and tightening torque			Base material
	N_{rec} [kN]	V_{rec} [kN]	T_{rec} [Nm]	
X-M6-7-24 B3 P7	0.05	0.05	3.0	Concrete, sand-lime masonry
X-W6-12-20 B3 P7				
X-M6-7-14 B3 P7	0.2	0.2	3.0	Steel
X-W6-12-14 B3 P7				

Recommended loads (electrical elements used with nails)

Element	Maximum service load F_{max} [N]
X-ECT (FR) MX	40
X-UCT MX	40
X-EKS MX	11
X-EKSC MX	32
X-FB MX / X-DFB MX	20
X-ECC MX	50
X-EHS MX	80
X-EKB (FR) 4 MX	9
X-EKB (FR) 8 MX	14
X-EKB (FR) 16 MX	18
X-ECH MX	40
	Cable trunking
X-ET MX	100

Conditions:

- Spacing \leq 100 mm
- All visible failures must be replaced

Nail recommendation

For **concrete** base material

Nail types	Length [mm]	Tip	Shank Ø [mm]	Material	Hardness [HRC]	Coating [µm]
X-P B3 P7/MX	17-36	Long conical	3.0	Carbon steel	57.5	Zinc, 2-10

- Premium nails (as listed above) are recommended for use on soft and some tough concrete. For more details regarding nail classification and concrete types, please refer to **Concrete Fastener Selection** section in Hilti Direct Fastening Technology Manual (DFTM)
- X-P 17/20/24 B3 MX to be used with BX 3 02, BX 3-L 02, BX 3-ME (02) and BX 3-IF
- X-P 30/36 B3 P7 to be used with BX 3-ME (02) and BX 3-IF

For **concrete** base material

Nail types	Length [mm]	Tip	Shank Ø [mm]	Material	Hardness [HRC]	Coating [µm]
X-C B3 MX	20-30 36	Cut	3.0 2.75	Carbon steel	56.5	Zinc, 5-13

- Standard nails (as listed above) are recommended for use on soft concrete only. For more details regarding nail classification and concrete types, please refer to **Concrete Fastener Selection** section in Hilti Direct Fastening Technology Manual (DFTM)
- X-C 20/24/27/30 B3 MX to be used with BX 3 02
- X-C 20/24/27/30/36 B3 MX to be used with BX 3-L 02
- X-C 20/24 B3 MX to be used with BX 3-ME (02) and BX 3-IF

For **steel** base material

Nail types	Length [mm]	Tip	Shank Ø [mm]	Material	Hardness [HRC]	Coating [µm]
X-S 14 B3 MX	14	Long conical	3.0	Carbon steel	57.5	Zinc, 2-10

- X-S 14 B3 MX to be used with BX 3 02, BX 3-L 02, BX 3-ME (02) and BX 3-IF
- Please refer to next pages for application limits on steel base material

Application requirements

Thickness of base material

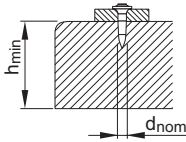

Concrete (for nails and threaded studs)
 $h_{min} = 60 \text{ mm}$
 $d_{nom} = 3.0 \text{ mm}$

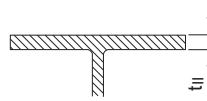

Steel
 $t_{II} \geq 4.0 \text{ mm}$ (for nails)
 $t_{II} \geq 6.0 \text{ mm}$ (for threaded studs)

Thickness of fastened material

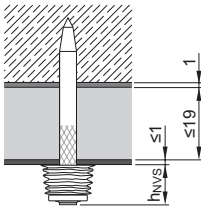

Wooden track: $t_1 \leq 27 \text{ mm}$ (conditions: head of the nail is countersunk flat to the surface)
 Metal track: $t_{II} \leq 2 \text{ mm}$
 Deflection head: $t_{1,tot.} \leq 21 \text{ mm}$ (gypsum strip + metal track and sealant)

Spacing and edge distances (mm)

Max. spacing along track

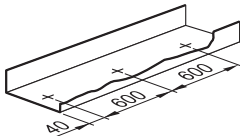

Fastener spacing max. 30 cm for proprietary light non-load-bearing partition walls with fire classification

All track ends (cut-outs for doors), secure with 2 nails

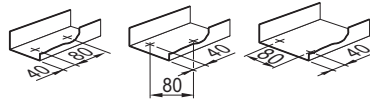

Distance to edge of concrete / sand-lime masonry

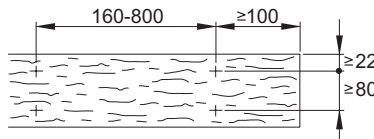
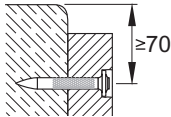

Spacing between nails when fastening wood to concrete

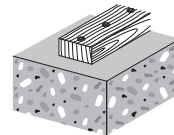

Based on common practice, spacing needs to be adjusted based on specific load requirement and achieved embedment depth.

Distance to edge of fastened material (steel base material)

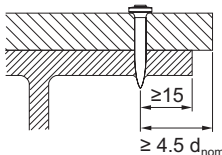

Application limits

X-S 14 B3 MX

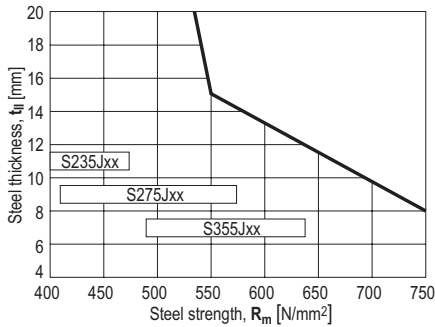

X-M6-7-14 B3 P7, X-W6-12-14 B3 P7

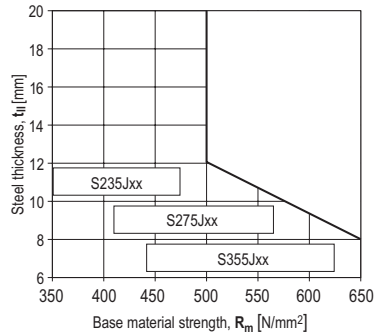

Corrosion information

The intended use only comprises fastenings which are not directly exposed to external weather conditions or moist atmospheres, i.e. only intended for dry indoor areas.

Fastener selection and system recommendation

Fastener program















Nails

Nail	Item no.	Shank length (mm)	Shank diameter (mm)	Base material	Length recommendation
X-S 14 B3 MX	2156392, 2156393	14	3	Steel	
X-P 17 B3 MX	2156216, 2156219	17	3	Concrete / Sand-lime masonry	
X-P 20 B3 MX	2156217, 2156390	20	3		
X-P 24 B3 MX	2156218, 2156391	24	3		
X-P 30 B3 P7	2105406	30	3		
X-P 36 B3 P7	2105407	36	3		
X-C 20 B3 MX	2123993	20	3		
X-C 24 B3 MX	2123994	24	3		
X-C 27 B3 MX	2224568	27	3		
X-C 30 B3 MX	2149988	30	3		
X-C 36 B3 MX	2149989	36	2.75		

Threaded studs







Threaded studs	Item no.	Thread size	Thread length (mm)	Shank length (mm)	Shank diameter (mm)	Base material
X-M6-7-14 B3 P7	2105408	M6	7	14	3	Steel
X-M6-7-24 B3 P7	2105409	M6	7	24	3	Concrete
X-W6-12-14 B3 P7	2105800	W6	12	14	3	Steel
X-W6-12-20 B3 P7	2105801	W6	12	20	3	Concrete

Fastener selection

	Nail Selector for BX 3-ME (02) and BX 3-IF 			
	Brick	Concrete Floor	Concrete Wall/Ceiling	Steel
 + 	X-C 24 B3 MX	X-C 20 B3 MX X-C 24 B3 MX	X-C 20 B3 MX X-P 17 B3 MX	X-S 14 B3 MX
 + 	-----	X-C 36 B3 P7	-----	-----
 + 	X-C 24 B3 MX X-C 20 B3 MX		X-P 20 B3 MX	X-S 14 B3 MX
 + 	X-P 20 B3 MX X-P 17 B3 MX	-----	X-P 17 B3 MX	X-S 14 B3 MX
 + 	-----	X-C 24 B3 MX X-C 20 B3 MX	-----	X-S 14 B3 MX
 + 	X-W6-12-20 B3 P7 X-M6-7-24 B3 P7			X-W6-12-14 B3 P7 X-M6-7-14 B3 P7
Propellant-free				

For more details and information, please contact your nearest Hilti representative.

Fastener selection

	Nail Selector for BX 3 02 and BX 3-L 02 			
	Brick	Concrete Floor	Concrete Wall/Ceiling	Steel
	X-C 24-36 B3 MX*	X-C 20 B3 MX X-C 24 B3 MX	X-C 20 B3 MX X-P 17 B3 MX	X-S 14 B3 MX
	-----	X-C 36 B3 MX*	-----	-----
	X-C 24 B3 MX X-C 20 B3 MX		X-P 20 B3 MX	X-S 14 B3 MX
	X-P 20 B3 MX X-P 17 B3 MX	-----	X-P 17 B3 MX	X-S 14 B3 MX
	-----	X-C 24 B3 MX X-C 20 B3 MX	-----	X-S 14 B3 MX
Propellant-free				

* X-C 36 B3 MX suitable for BX 3-L 02 only

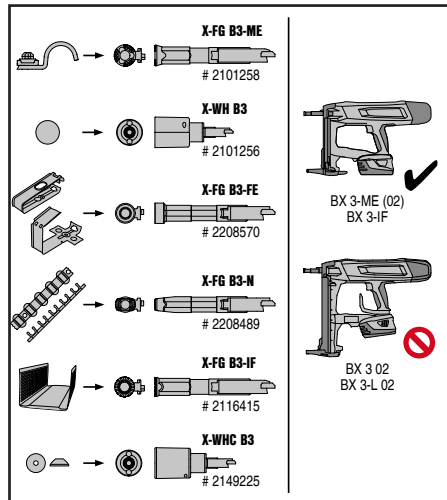
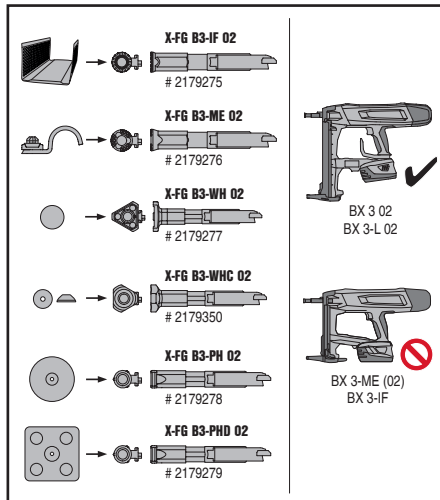

Fastening quality assurance

Fastening inspection

Nails and studs in concrete / sand-lime masonry

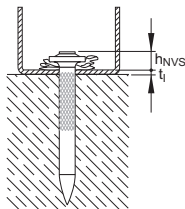

X-C_B3, X-P_B3:
 $h_{NVS} = 2-5 \text{ mm}$

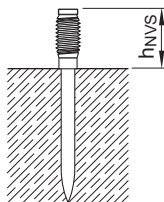

X-M6-7-24 B3 P7
X-W6-12-20 B3 P7

$h_{NVS} \geq 7 \text{ mm}$
 $\geq 12 \text{ mm}$

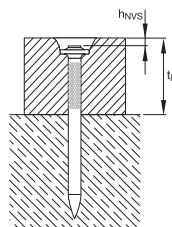

X-C_B3, X-P_B3:
 $h_{NVS} = 2-3 \text{ mm}$

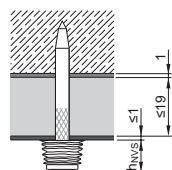

Deflection head
X-P 36 B3 P7, X-C 36 B3 MX
12.5 mm board: $h_{NVS} \leq 12 \text{ mm}$
15 mm board: $h_{NVS} \leq 9 \text{ mm}$
19 mm board: $h_{NVS} \leq 5 \text{ mm}$

Nails and studs in steel

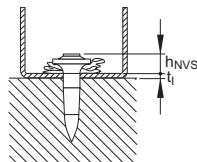

X-S_B3:
 $h_{NVS} = 2-9 \text{ mm}$

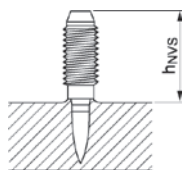

X-M6-7-14 B3 P7
X-W6-12-14 B3 P7
 $h_{NVS} \geq 7 \text{ mm}$
 $\geq 12 \text{ mm}$

Element	$h_{NVS} \text{ (mm)}$	
	Concrete	Steel
X-EKB 4/8 MX	6-11	6-9
X-EKB 16 MX	6-11	6-9
X-ECT MX	6-11	6-9
X-UCT MX	6-11	6-9
X-ECH MX	6-11	6-9
X-EKS MX	6-11	6-9
X-EKSC MX	6-11	6-9
X-FB MX	7-11	7-9
X-DFB MX	7-11	7-9
X-ECC MX	7-11	7-9
X-EHS MX	7-11	7-9
X-ET MX*	5-10	5-9

*) With X-ET MX, the h_{NVS} is measured against the cable trunk.

Examples

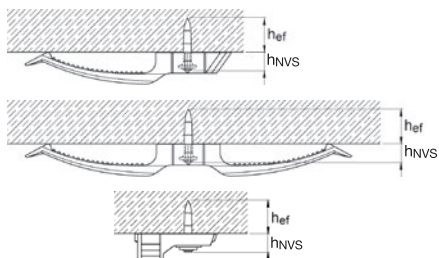

BX-Kwik Electrical hanger system

Product data

X-EHS MX

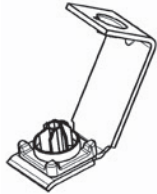

X-P 24 B3 MX

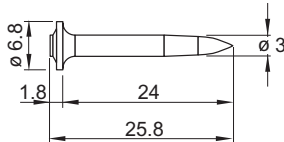

Features and benefits

A special hanger system with pre-drilled pilot hole optimized for higher load and close to **100% stick rate** for applications on **soft & tough** concrete.

General information

The system consists of:

- X-EHS MX hanger
- TX-C-5/10B drill bit
- X-P 24 B3 MX nail
- BX 3 ME

Material Specifications

Hanger:

Zinc coating $\geq 10 \mu\text{m}$

Nail:

Carbon Steel 57.5 HRC

Zinc Coating 2 – 10 μm

Applications

Examples



Threaded rod attachments to concrete



Cable trays

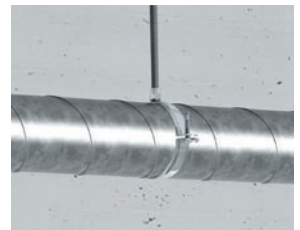

Small pipes

These zinc coated fasteners are not suitable for long-term service outdoors or in otherwise corrosive environments. For further detailed information on corrosion see chapter **Direct Fastening Principles and Technique**.

These fasteners are not recommended for fastening of suspended ceilings.

Performance data on concrete

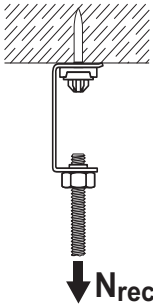

Recommended Tension Load N_{rec} [kN]	
Concrete Toughness ¹⁾	
Soft	Tough
0.3	0.45

Stick rate estimation ¹⁾	
Soft Concrete	Tough Concrete
95-100 %	95-100 %

Conditions:

- A sufficient redundancy has to be ensured, that a failure of a single fastening will not lead to collapse of the entire system.
- Soft concrete up to $f_{c,cube} = 45 \text{ N/mm}^2$ (C35/45).
- Tough concrete up to $f_{c,cube} = 60 \text{ N/mm}^2$ (C50/60).
- Concrete with aggregate like granite or river rock or softer, and up to 16 mm diameter.
- Loads valid for cracked and uncracked concrete.

¹⁾ The stick rate indicates the percentage of nails that were driven correctly to carry a load. Stick rate can vary from the above value depending on job site conditions.

For more details regarding fastener behaviour and concrete types, please refer to

Concrete Fastener Selection section.

Application requirements

Thickness of base material

Concrete:

$h_{min} = 60 \text{ mm}$

Edge distance and fastener spacing

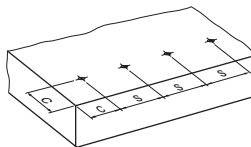

Edge distance: $c \geq 70 \text{ mm}$

Spacing: $s \geq 100 \text{ mm}$

Installation

Pre-drilling details

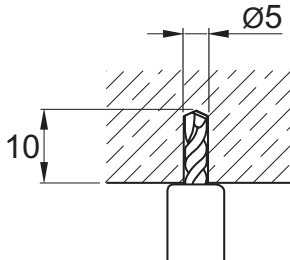

Pre-drilling with Hilti drill bit **TX-C-5/10B** until a ring on the concrete surface is visible.

Fastener selection and system recommendation

Fastener program

Hanger	Item no.
X-EHS M4 MX	273367
X-EHS M6 MX	272073
X-EHS M8 MX	273368

Nail	Item no.
X-P 24 B3 MX	2105405

Drill-bit	Item no.
TX-C-5/10B	2178329

Fastening quality assurance

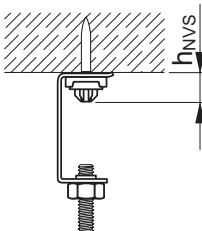

$h_{NVS} = 4.0 - 7.0 \text{ mm}$

Approvals

Lloyds Register: X-HS

ICC, UL, FM: X-HS W6/10

Note: technical data presented in these approvals and design guidelines reflect specific local conditions and may differ from those published in this handbook.

Applications

Examples

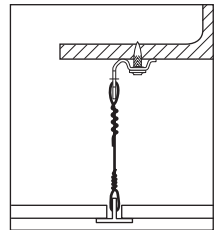
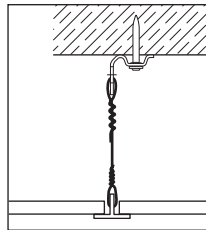
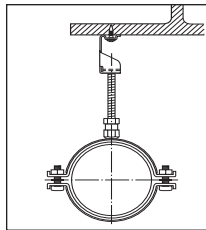
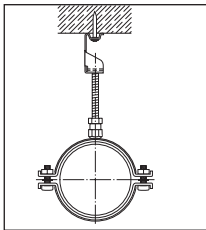

Threaded rod attachments to concrete and steel

Wire attachments to concrete and steel

Load data

Recommended loads

Concrete (DX-Kwik with pre-drilling) or steel

X-HS

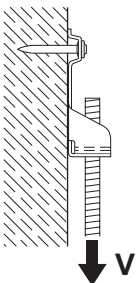
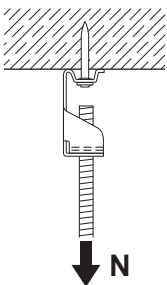

Fastener designation	$N_{rec} = V_{rec}$ [kN]	Base material
X-HS __ DKH 48	0.9	Concrete
X-HS __ U19	0.9	Steel
X-CC DKH 48	0.9	Concrete
X-CC U16	0.9	Steel

Conditions:

- Predominantly static loading.
- Concrete C20/25–C50/60
- Strength of fastened material is not limiting.
- Observance of all application limitations and recommendations (especially pre-drilling requirements).

X-CC

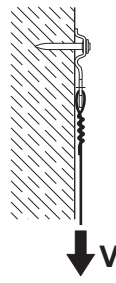
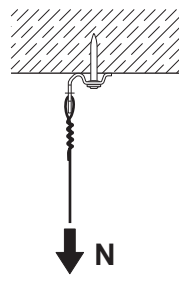

Concrete (DX Standard without pre-drilling)

X-HS

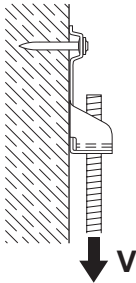
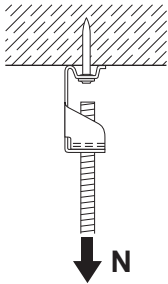

Fastener designation	N _{rec} [kN]	V _{rec} [kN]	h _{ET} [mm]
X-HS_U32	0.4	0.4	27
X-HS_U27	0.3	0.3	22
X-HS_U22	0.2	0.2	18
X-CC_U27	0.2*	0.3	22
X-CC_U22	0.15*	0.2	18
X-CC_CS27	0.2	0.3	22
X-CC_CS22	0.15	0.2	18

*) eccentric loading considered

Conditions:

- Minimum 5 fastenings per fastened unit (normal weight concrete).
- All visible failures must be replaced.
- With lightweight concrete base material and appropriate washers, greater loading may be possible, please contact Hilti.
- Predominantly static loading.
- Observance of all application limitations and recommendations.

X-CC

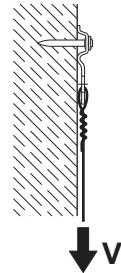
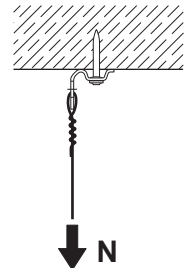

Application requirements

Thickness of base material

Concrete

DX-Kwik

(with pre-drilling) **h_{min} = 100 mm**

DX Standard

(w/o pre-drilling) **h_{min} = 80 mm**

Steel

t_{fl} ≥ 4 mm

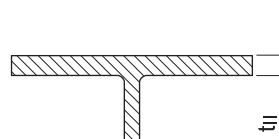

Spacing and edge distances

Minimum spacing and edge distances: See corresponding nail data sheet of X-U and X-DKH.

Corrosion information

These zinc-coated fasteners are not suitable for long-term service outdoors or in otherwise corrosive environments.

For further detailed information on corrosion see relevant chapter in **Direct Fastening Principles and Technique** section.

Application limits

Fastening to steel – X-HS U19 with DX351

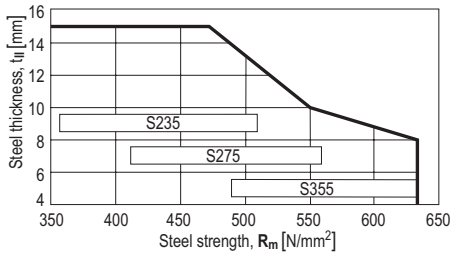

Application limit may increase in case of specific applications, like the fastening of wire mesh to steel, which is connected with X-CC U16 P8 fasteners. That wire mesh acts as reinforcement for fire protective sprayed coating. In such cases also different fastener stand-offs apply. Inquire at Hilti related with the use of X-CC U16 P8 in that specific application.

Fastener selection

Program, technical information

Base material	Fastener Designation	Shank Ø d_s [mm]	Shank length L_s [mm]	L [mm]	Tools
① Concrete pre-drilled	X-HS_ DKH 48 P8S15	4.0	48	50.0	DX 460-F8, DX 5 F8
② Concrete	X-HS_ U 32 P8S15	4.0	32	34.4	DX 460-F8, DX 5 F8
	X-HS_ U 27 P8S15	4.0	27	29.4	DX 351-F8,
	X-HS_ U 22 P8S15	4.0	22	24.4	DX 36, DX 2
Steel	X-HS_ U 19 P8S15	4.0	19	21.4	
③ Concrete pre-drilled	X-CC DKH 48 P8S15	4.0	48	50.0	DX 460-F8, DX 5 F8
③ Concrete	X-CC U 27 P8	4.0	27	29.4	DX 460-F8, DX 5 F8
	X-CC U 22 P8	4.0	22	24.4	DX 351-F8,
	X-CC U 16 P8	4.0	16	18.4	DX 36, DX 2
Steel					

Type of threading: M = metric; W6, W10 = Whitworth 1/4"; 3/8"

X-HS order information

Item no.	Designation	Item no.	Designation
361788	X-HS M6 U32 P8 S15	386214	X-HS M8 U19 P8 S15
386223	X-HS M6 U27 P8 S15	386215	X-HS M10 U19 P8 S15
361789	X-HS M8 U32 P8 S15	386217	X-HS W10 U19 P8 S15
386224	X-HS M8 U27 P8 S15	386218	X-HS M6 U22 P8 S15
361790	X-HS M10 U32 P8 S15	386219	X-HS M8 U22 P8 S15
386225	X-HS M10 U27 P8 S15	386222	X-HS W10 U22 P8 S15
386226	X-HS W6 U27 P8 S15	386216	X-HS W6 U19 P8 S15
386227	X-HS W10 U27 P8 S15	386220	X-HS M10 U22 P8 S15
386213	X-HS M6 U19 P8 S15	386221	X-HS W6 U22 P8 S15

Type of threading: M = metric; W6, W10 = Whitworth 1/4"; 3/8"

X-CC order information

Item no.	Designation
386229	X-CC U22 P8
386230	X-CC U27 P8
299937	X-CC DKH P8 S15
386228	X-CC U16 P8
2006454	X-CC CS22 P8
2005065	X-CC CS27 P8

Cartridge selection

Cartridge recommendation:

Steel:	6.8/11M red cartridge	$t_{II} \geq 6 \text{ mm}$
	6.8/11M green cartridge	$t_{II} < 6 \text{ mm}$
Concrete:	6.8/11M yellow cartridge	on soft and tough concrete
	6.8/11M red cartridge	on very tough concrete

Tool energy adjustment by setting tests on site.

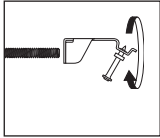
Fastening quality assurance
Installation
X-HS

1. Attach the threaded rod to the X-HS before fastening

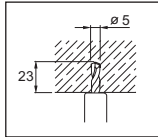

2. For **DKH 48** pre-drill ($\varnothing 5 \times 23$)

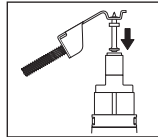

3. Load the assembly into the tool

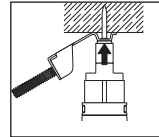

4. Locate the nail, compress the tool, pull the trigger and the fastening is complete

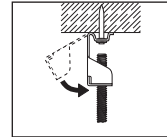

5. Bend the X-HS assembly down to the vertical position

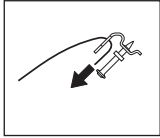
X-CC

1. Assemble the wire with the **X-CC**

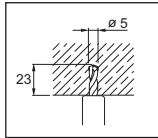

2. For **DKH 48** pre-drill ($\varnothing 5 \times 23$)

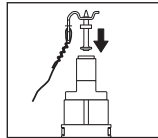

3. Load the assembly into the tool

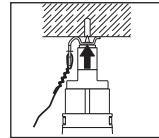

4. Locate the nail, compress the tool, pull the trigger and the fastening is complete

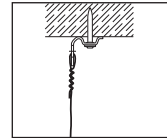

5. Adjust the wire as required

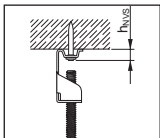
Quality assurance
X-HS

$h_{NVS} = 6-10 \text{ mm}$

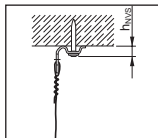
X-CC

$h_{NVS} = 4-7 \text{ mm}$

These are abbreviated instructions which may vary by application.
ALWAYS review/follow the instructions accompanying the product.

X-EHS MX, X-ECC MX Electrical hanger system

Product data

Dimensions

X-EHS MX

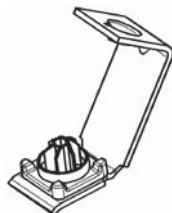

X-ECC MX

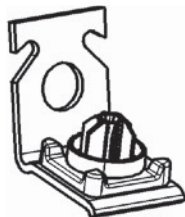

X-GHP 20/24

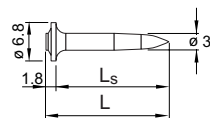

X-EGN 14

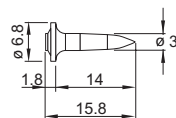

X-U 16/22

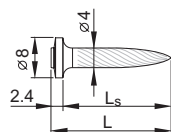

X-P 22

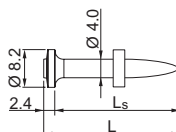

General information

Material specifications

X-EHS MX / X-ECC MX:

Zinc coating: $\geq 5 \mu\text{m}$

Recommended fastening tools

DX 460 MX, DX 5 MX, DX 351 MX,
GX 120 ME, GX 3 ME, BX 3 ME

See **X-EHS MX** and **X-ECC MX fastener program** in the next pages and **Tools and equipment chapter** for more details.

X-P 20/24 G3 MX

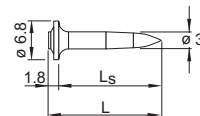

X-P 20/24 B3 MX

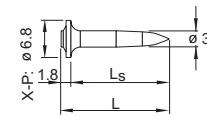

X-S 14 G3 MX

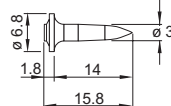

X-S 14 B3 MX

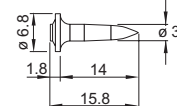

Applications

Example

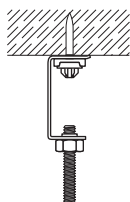

Hanger systems for light cable trays, etc.

- Threaded rod attachments
- Wire attachments

These fasteners are not recommended for fastening of suspended ceilings.

These zinc coated fasteners are not suitable for long-term service outdoors or in otherwise corrosive environments.

Load data
Recommended loads on concrete

Fastener designation	$N_{rec} = V_{rec}$ [kN]
X-EHS MX	0.1
X-ECC MX	0.05 (N_{rec}^*)
	0.1 (V_{rec})

*) eccentric loading considered

Conditions:

- Fastened with X-P 20/24 G3 MX, X-P 20/24 B3 MX, X-GHP 20/24 MX, X-U 22 or X-P 22
- Minimum 5 fastenings per fastened unit (normal weight concrete).
- All visible failures must be replaced.
- With lightweight concrete base material and appropriate washers, greater loading may be possible, please contact Hilti.
- Predominantly static loading.
- Observance of all application limitations and recommendations.

Recommended loads on steel

Fastener designation	$N_{rec} = V_{rec}$ [kN]
X-EHS MX, X-ECC MX	0.45

Fastened with X-S 14 G3 MX, X-S 14 B3 MX, X-EGN 14 or X-U 16

Application requirements
Thickness of base material
Concrete

X-U, X-P: $h_{min} = 80$ mm
 X-P G3 MX, X-P B3 MX, X-GHP: $h_{min} = 60$ mm

Steel

$t_{fl} \geq 4$ mm

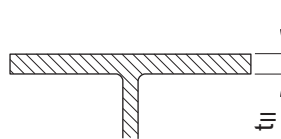
Spacing and edge distances

Spacing and edge distances depending on job site requirements.

Corrosion information

These zinc-coated fasteners are not suitable for long-term service outdoors or in otherwise corrosive environments.

For further detailed information on corrosion see relevant chapter in **Direct Fastening Principles and Technique** section.

Application limits

Fastening to steel

X-EGN 14, X-S 14 G3 MX, X-S 14 B3 MX

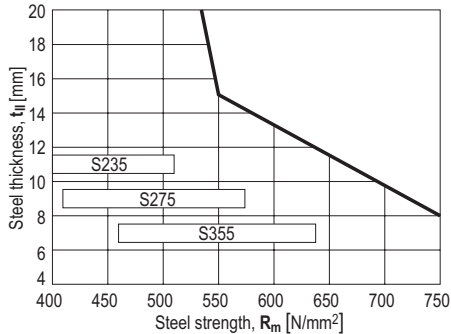

Fastener program

Fastener selection

Base material	Nail			
	Designation	Shank Ø d_s [mm]	Shank length L_s [mm]	L [mm]
Concrete	X-P 20 G3 MX	3.0	20	21.8
	X-P 24 G3 MX	3.0	24	25.8
	X-P 20 B3 MX	3.0	20	21.8
	X-P 24 B3 MX	3.0	24	25.8
	X-GHP 20 MX	3.0	20	21.8
	X-GHP 24 MX	3.0	24	25.8
	X-P 22 MX	4.0	22	24.4
	X-U 22 MX	4.0	22	24.4
Steel	X-S 14 G3 MX	3.0	14	15.8
	X-S 14 B3 MX	3.0	14	15.8
	X-EGN 14 MX	3.0	14	15.8
	X-U 16 MX	4.0	16	18.4

Fastener selection: Order information

Fastener	Designation	Item no.
Threaded Rod Hanger	X-EHS M4 MX	273367
	X-EHS M6 MX	272073
	X-EHS W6 MX	228341
	X-EHS M8 MX	273368
	X-EHS W10 MX	386468
Ceiling clip	X-ECC MX	228342

System recommendation

DX tools: Steel: **6.8/11M yellow or red cartridge**
 Concrete: **6.8/11M yellow cartridge** on soft and tough concrete
6.8/11M yellow or red cartridge on very tough concrete

GX 120-ME tool: **gas can GC 20, GC21 and GC22**

GX 3 ME tool: **gas can GC 40, GC 41 and GC42**

BX 3-ME tool: **No gas can required**

Tool energy adjustment by setting tests on site.

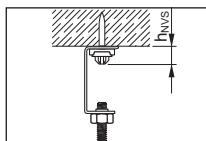
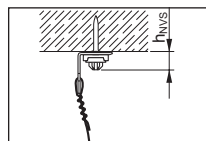
Fastening quality assurance
X-EHS MX

 $h_{NVS} = 4-8 \text{ mm}$
X-ECC MX

 $h_{NVS} = 4-8 \text{ mm}$

X-DHS MX Pipe support system

Product data

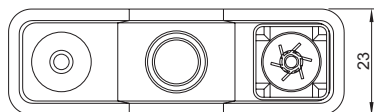
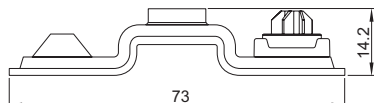
Dimensions

X-DHS 3/8" MX



Features and benefits

- Securely fastened threaded rod hangers to steel and concrete (soft and tough) base material
- Easy installation of threaded rods on floors, walls and ceiling

General information

Material specification

X-DHS:

Zinc coating 10-20 µm

Applications

Example



Hanger system for:

- Light-duty fastenings of pipes on ceilings
- Supporting pipes on floors
- Positioning of vertical pipes on walls

These fasteners are not recommended for fastening of suspended ceilings.

These zinc coated fasteners are not suitable for long-term service outdoors or in otherwise corrosive environments.

Load data

Recommended loads (Base material = concrete)

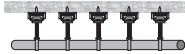
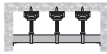
Number of X-DHS MX elements per pipe	N_{rec} [kN] per X-DHS MX
≥ 5 	0.2
1 to 4 with fixed end supports 	0.2

Design conditions:

- Each X-DHS MX element has to be fastened with 2 nails
- All visible failures must be replaced.
- Predominantly static loading.
- Valid for soft and tough concrete with strength of $f_{c, cube} = 25-60 \text{ N/mm}^2$. For more details regarding concrete types, please refer to **Concrete Fastener Selection** section in Hilti Direct Fastening Technology Manual (DFTM).
- Observance of all application limitations and recommendations.
- **For wall application (i.e. vertical pipes on walls), X-DHS MX is used for positioning purpose only, with NO imposed loading.**
- Maximum spacing = 100 cm

Recommended loads (Base material = steel)

Fastener	N_{rec} [kN]
Recommended load per X-DHS MX element (fastened with 2 Nails)	0.8

Nail recommendations

For **concrete** base material

Fastening tool	Nail types	Length [mm]	Tip	Shank Ø [mm]	Material	Hardness [HRC]	Coating [µm]
BX3	X-P B3 MX	24	Ballistic	3.0	Carbon steel	57.5	Zinc, 2-13 µm
GX3	X-P G3 MX					57.5	Zinc, 2-13 µm
GX120	X-GHP MX					57.5	Zinc, 2-13 µm

- For X-DHS MX element, only 24 mm length nails are recommended for concrete base material to ensure sufficient embedment depth.
- Premium nails (as listed above) are the only recommended nails based on intended use of X-DHS element (soft and some tough concrete, GX/BX tools). For more details regarding nail classification and concrete types, please refer to **Concrete Fastener Selection** section in Hilti Direct Fastening Technology Manual (DFTM).

For **steel** base material

Fastening tool	Nail types	Length [mm]	Tip	Shank Ø [mm]	Material	Hardness [HRC]	Coating [µm]
BX3	X-P B3 MX	17	Ballistic	3.0	Carbon steel	57.5	Zinc, 2-13 µm
GX3	X-P G3 MX	17				57.5	Zinc, 2-13 µm
GX120	X-GHP MX	18				57.5	Zinc, 2-13 µm

- For X-DHS MX element, only 17-18 mm length nails are recommended for steel base material to ensure sufficient embedment depth.

Application requirements

Thickness of base material

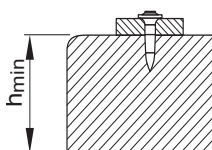

Concrete

X-GHP MX, X-P G3 MX,
X-P B3 MX

$h_{\min} = 60 \text{ mm}$

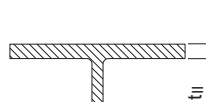

Steel

X-GHP MX, X-P G3 MX,
X-P B3 MX

$t_{II} \geq 4.0 \text{ mm}$

Application limits

X-P 17 G3 MX, X-P 17 B3 MX, X-GHP 18 MX

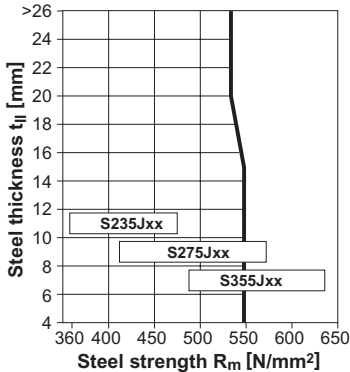

Corrosion information

These zinc-coated fasteners are not suitable for long-term service outdoors or in otherwise corrosive environments. For further detailed information on corrosion see relevant chapter in **Direct Fastening Principles and Technique** section.

Fastener selection and system recommendation

Fastener program

Designation	Item no.
X-DHS 3/8" MX	2161569

System recommendation

GX 120-ME	Gas can GC 20, GC 21 and GC 22
GX 3-ME	Gas can GC 40, GC 41 and GC 42
BX 3-ME	No gas can required

Fastening quality assurance

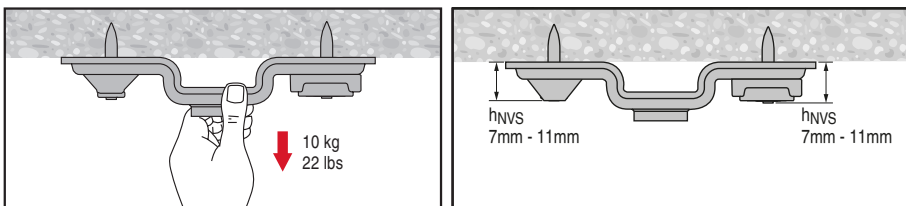

X-HS-W Wire hanging system

Product data

Fasteners/Components Overview

Pre assembled

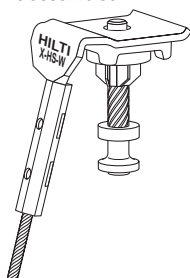

X-GHP 20/24

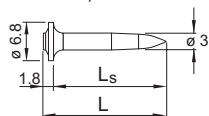

X-P 20/24 G3 MX

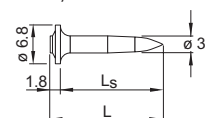

Magazined

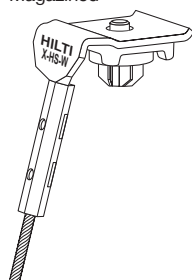

X-P 20/24 B3 MX

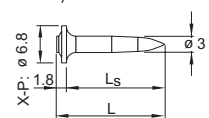

X-EGN 14

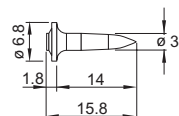

General information

Material specifications

X-HS-W:
Zinc coating $\geq 2.5 \mu\text{m}$

Recommended fastening tools

DX 460F8, DX 5 F8, DX 351 F8, GX 120 ME,
GX 3 ME, BX 3 ME

See **X-HS-W fastener program** in the next pages
and **Tools and equipment** chapter for more details.

Approvals

CSTB AT 3/09-639 X-HS-W

Locking Mechanism

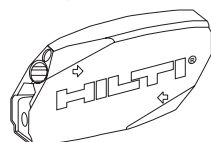

X-S 14 G3 MX

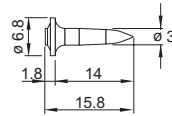

X-S 14 B3 MX

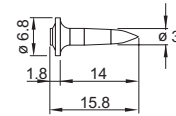

Applications

Examples



Round Air Ducts



Square Air Ducts



Light weight Cable Trays / Lights

Load data
Recommended loads
DX Standard for concrete

Fastener designation	N_{rec} [kN]	V_{rec} [kN]	h_{ET} [mm]
X-HS-W U27	0.20	0.3	22
X-HS-W U22	0.15	0.2	18
X-HS-W MX with X-P 20/24 G3 MX, X-P 20/24 B3 MX, X-GHP 20/24 MX	0.05	0.1	14

Conditions:

- Minimum 5 fastenings per fastened unit (normal weight concrete).
- All visible failures must be replaced.
- Predominantly static loading.
- Observance of all application limitations and recommendations.

DX Standard for steel

Fastener designation	N_{rec}	V_{rec}
X-HS-W U16	0.90	0.90
X-HS-W MX with X-S 14 G3 MX, X-S 14 B3 MX, X-EGN 14 MX	0.45	0.45

Conditions:

- Predominantly static loading.
- Observance of all application limitations and recommendations.

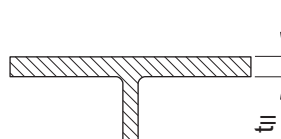
Application requirements
Thickness of base material
Concrete
X-U: $h_{min} = 80 \text{ mm}$
X-P G3 MX, X-P B3 MX
X-GHP MX $h_{min} = 60 \text{ mm}$
Steel
 $t_{II} \geq 4 \text{ mm}$

Spacing and edge distances

Spacing and edge distances depending on job site requirements.

Corrosion information

These zinc-coated fasteners are not suitable for long-term service outdoors or in otherwise corrosive environments.

For further detailed information on corrosion see relevant chapter in **Direct Fastening Principles and Technique** section.

Application limits

Steel

X-HS-W MX with X-S 14 G3 MX, X-S 14 B3 MX, X-EGN 14 MX

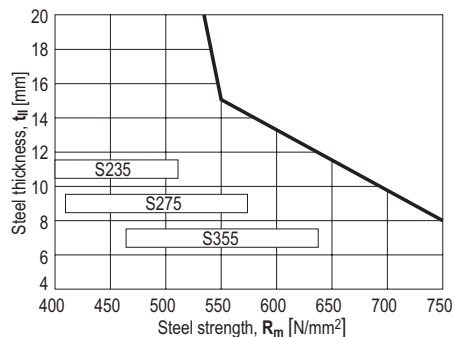

X-HS-W U16 P8

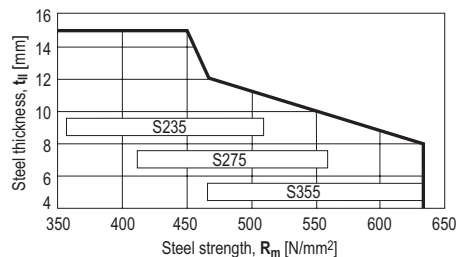

Fastener selection: Order information

Fastener		Designation	Item no.
X-HS-W	For DX tools	X-HS-W U16 P8 1m/3ft	387430
		X-HS-W U22 P8 1m/3ft	387431
		X-HS-W U27 P8 1m/3ft	387432
		X-HS-W U16 P8 2m/7ft	387919
		X-HS-W U22 P8 2m/7ft	387920
		X-HS-W U27 P8 2m/7ft	387921
		X-HS-W U16 P8 3m/10ft	387433
		X-HS-W U22 P8 3m/10ft	387434
		X-HS-W U27 P8 3m/10ft	387435
X-HS-W	For GX tools and BX tools	X-HS-W MX 1m/3ft	387436
		X-HS-W MX 2m/7ft	387922
		X-HS-W MX 3m/10ft	387437

System recommendation

DX tools: Steel: **6.8/11M red cartridge** for $t_{ij} \geq 6$
6.8/11M green cartridge for $t_{ij} < 6$
Concrete: **6.8/11M green or yellow cartridge** on soft and tough concrete
6.8/11M red cartridge on very tough concrete

GX 120-ME tool: **gas can GC 20, GC21 and GC22**

GX 3 ME tool: **gas can GC 40, GC 41 and GC 42**

BX 3-ME tool: **no gas can required**

Tool energy adjustment by setting tests on site.

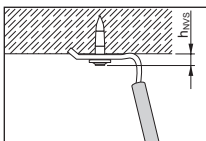
Fastening quality assurance
X-HS-W

$h_{NVS} = 5.5-8.5 \text{ mm}$

NO LIFTING

Do not use for lifting, such as in a crane or pulley situation.

NO MOVEMENT

Hilti hangers are to be used to suspend stationary loads only. Do not use to suspend moving services, or services likely to be subject to movement.

NO JOINING

Hilti hangers must not be used as an in-line joint using a Hilti fastener, or any other joining device. A Hilti hanger assembly must comprise one length of cable and one Hilti fastener only. If a longer length is needed, do not join two assemblies together.

X-EKB, X-ECH Electrical fastener

Product data

Dimensions

Single Fastener

X-EKB 8/4-FR

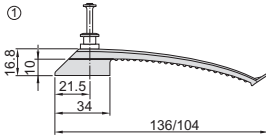

X-EKB 16 (FR)

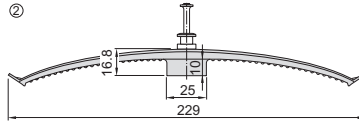

X-U 37 PH

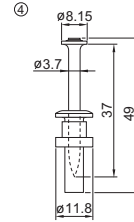

X-ECH-S (FR)

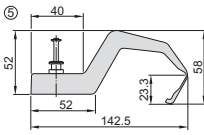

X-ECH-M (FR)

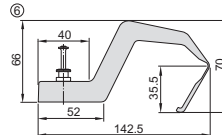

X-ECH-L (FR)

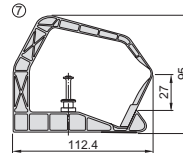

Magazine fastener

X-EKB 4 / 8 / 16 MX (FR)

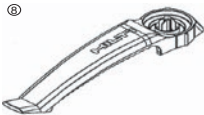

X-EKB 4 MX (FR)

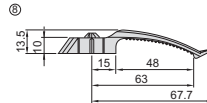

X-ECH-B MX

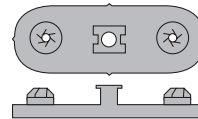

X-ECH-15/30 MX

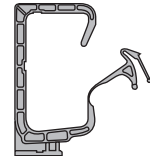

X-GHP 20/24

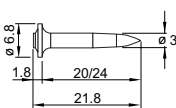

X-GN 27

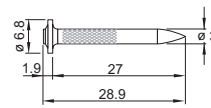

X-EGN 14

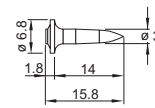

X-U 16/22/27

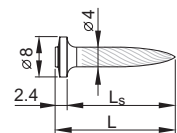

X-P 20/24 G3 MX

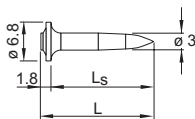

X-C 27 G3 MX

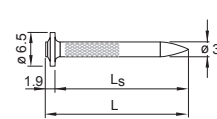

X-S 14 G3 MX

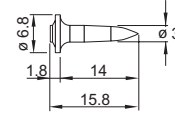

X-P 22

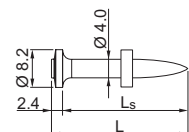

X-P 20/24 B3 MX

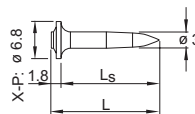

X-S 14 B3 MX

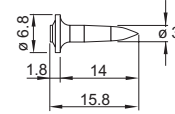

General information

Material specifications

See Fastener selection

Recommended fastening tools

DX 460-F8, DX 460 MX, DX 5 F8, DX 5 MX, DX 351-F8, DX 351 MX, DX36, DX 2, GX 120 ME, GX 3 ME, BX 3 ME

See **X-EKB, X-ECH fastener program** in the next pages and **Tools and equipment chapter** for more details.

Approvals

UL (USA): X-EKB MX, X-ECH / FR_U37

CSTB (France): X-EKB_U 37, X-ECH_U37

Note: technical data presented in these approvals and design guidelines reflect specific local conditions and may differ from those published in this handbook.

Applications

Examples

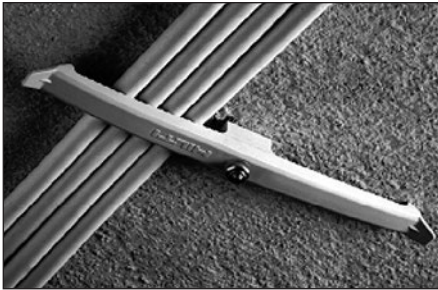

X-EKB for fastening cables



X-ECH for fastening bunched cables

Load data

Fastener capacity

X-EKB: Securing electrical cables to concrete ceilings and walls

Max. capacity (number of cables in one **X-EKB**) at spacing of 50–100 cm

Designation	Number of wires/cables and wire sizes	
	NYM 3 x 1.5 mm² (∅ 8 mm)	NYM 5 x 1.5 mm² (∅ 10 mm)
X-EKB 4 __	4	3
X-EKB 8 __	8	5
X-EKB 16 __	16	10

X-ECH: Securing electrical cable to ceilings and walls

Designation	No. of nails	Number of cables
X-ECH-S __ and X-ECH/FR-S __		max. 15 NYM 5x1.5 ² (Ø 10 mm)
X-ECH-M __ and X-ECH/FR-M __		max. 25 NYM 5x1.5 ² (Ø 10 mm)
X-ECH-L __ and X-ECH/FR-L __		max. 35 NYM 5x1.5 ² (Ø 10 mm)
X-ECH-15 MX and X-ECH-B	1 or 2	max. 15 NYM 3x1.5 ² (Ø 10 mm)
X-ECH-30 MX and X-ECH-B	1 or 2	max. 30 NYM 3x1.5 ² (Ø 10 mm)

Conditions:

- For concrete C12/15 to C45/55 ($f_{cc} = 15$ to 55 N/mm²)
- All visible placing failures have to be replaced
- Damaged X-ECH have to be replaced

Application requirements

Thickness of base material

Concrete

X-U, X-P: $h_{min} = 80$ mm

X-P G3 MX, X-P B3 MX,

X-GHP MX, X-GN MX $h_{min} = 60$ mm

Steel

$t_{II} \geq 4$ mm

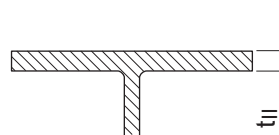

Thickness of fastened material

Fasteners recommended for cable Ø 8 mm and 10 mm

Spacing and edge distances

X-EKB: approximately 50–100 cm (Adjust as necessary to control cable sag)

X-ECH: approximately 60– 80 cm (Adjust as necessary to limit sagging)

Corrosion information

These zinc-coated fasteners are not suitable for long-term service outdoors or in otherwise corrosive environments.

For further detailed information on corrosion see relevant chapter in **Direct Fastening Principles and Technique** section.

Fastener program
Fastener with pre-mounted DX-nail: Technical information

Fastener Designation	Shank		Tools
	Ø d_s [mm]	length L_s [mm]	
① X-EKB8 U 37	4.0	37	DX 460-F8, DX 5 F8, DX351-F8, DX36, DX 2
② X-EKB16 U 37	4.0	37	DX 460-F8, DX 5 F8, DX351-F8, DX36, DX 2
⑤ X-ECH-S U 37	4.0	37	DX 460-F8, DX 5 F8, DX351-F8, DX36, DX 2
⑥ X-ECH-M U 37	4.0	37	DX 460-F8, DX 5 F8, DX351-F8, DX36, DX 2
⑦ X-ECH-L U 37	4.0	37	DX 460-F8, DX 5 F8, DX351-F8, DX36, DX 2
① X-EKB4-FR U 37	4.0	37	DX 460-F8, DX 5 F8, DX351-F8, DX36, DX 2
① X-EKB8-FR U 37	4.0	37	DX 460-F8, DX 5 F8, DX351-F8, DX36, DX 2
② X-EKB16-FR U 37	4.0	37	DX 460-F8, DX 5 F8, DX351-F8, DX36, DX 2
⑤ X-ECH/FR-S U 37	4.0	37	DX 460-F8, DX 5 F8, DX351-F8, DX36, DX 2
⑥ X-ECH/FR-M U 37	4.0	37	DX 460-F8, DX 5 F8, DX351-F8, DX36, DX 2
⑦ X-ECH/FR-L U 37	4.0	37	DX 460-F8, DX 5 F8, DX351-F8, DX36, DX 2

③, ④ All nail shanks: carbon steel, HRC 58, galvanized 2–20 µm

Sleeve/thimble: carbon steel, not hardened, galvanized 5–13 µm

Ⓜ–Δ See Product data in previous pages

Fastener with pre-mounted DX-nail: Order information

Designation	Item no.	Plastic material
X-EKB 4-FR U37	361581	Polyamide ²⁾
X-EKB 8 U37	386231	Polyamide ¹⁾
X-EKB 8-FR U37	386233	Polyamide ²⁾
X-EKB 16 U37	386232	Polyamide ¹⁾
X-EKB 16-FR U37	386234	Polyamide ²⁾
X-ECH-S U37	386235	Polyamide ¹⁾
X-ECH-M U37	386236	Polyamide ¹⁾
X-ECH-L U37	386237	Polyamide ¹⁾
X-ECH/FR-S U37	386238	Polyamide ²⁾
X-ECH/FR-M U37	386239	Polyamide ²⁾
X-ECH/FR-L U37	386240	Polyamide ²⁾

¹⁾ halogen and silicone free, light grey RAL 7035

²⁾ halogen and silicone free, flame retardant, stone grey RAL 7030

Fastener without pre-mounted nail: Technical information

Base material	Cable Holder	Fastening Technology	Nail
Concrete	X-EKB (FR) 4 MX X-EKB (FR) 8 MX X-EKB (FR) 16 MX X-ECH-15 MX* X-ECH-30 MX*	GX	X-P 20/24 G3 MX
		GX	X-C 27 G3 MX
		GX	X-GHP 20/24 MX
		GX	X-GN 27 MX
		BX	X-P 20/24 B3 MX
		DX	X-U 22/27 MX
		DX	X-P 22/27 MX
Steel	X-ECH-30 MX*	GX	X-S 14 G3 MX
		GX	X-EGN 14 MX
		BX	X-S 14 B3 MX
		DX	X-U 16 MX

* To be used with GX or BX technology ONLY

Fastener without pre-mounted nail: Order information

Fastener	Plastic material	Designation	Item no.
Electrical Cable Holder	Polyamide ¹⁾	X-EKB 4 MX	285712
	Polyamide ¹⁾	X-EKB 8 MX	285713
	Polyamide ¹⁾	X-EKB 16 MX	285714
	Polyamide ²⁾	X-EKB FR 4 MX	285715
	Polyamide ²⁾	X-EKB FR 8 MX	285716
	Polyamide ²⁾	X-EKB FR 16 MX	285717
	Polyamide ¹⁾	X-ECH-15 MX	2018247
	Polyamide ¹⁾	X-ECH-30 MX	2018248
	Polyamide ¹⁾	X-ECH-15/B MX	2018729 (kit)
	Polyamide ¹⁾	X-ECH-30/B MX	2018891 (kit)
Polyamide ¹⁾	X-ECH-B MX	2018391	

¹⁾ halogen and silicone free, light grey RAL 7035

²⁾ halogen and silicone free, flame retardant, stone grey RAL 7030

System recommendation

DX tools:	Steel:	6.8/11M red cartridge
	Concrete:	6.8/11M yellow cartridge on soft and tough concrete 6.8/11M red cartridge on very tough concrete
	Masonry:	6.8/11M yellow or green cartridge, green for MX Fastener

GX 120-ME tool: **Gas can GC 20, GC21 and GC22**

GX 3 ME tool: **Gas can GC 40, GC 41 and GC 42**

BX 3-ME tool: **no gas can required**

Tool energy adjustment by setting tests on site.

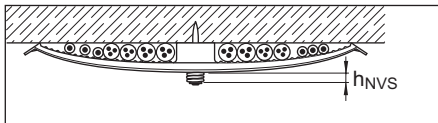
Fastening quality assurance
X-EKB fastening quality

$h_{NVS} = 7 \pm 2 \text{ mm}$

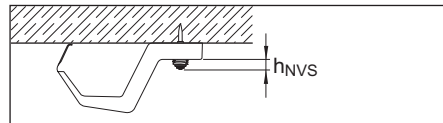
X-ECH fastening quality

$h_{NVS} = 7 \pm 2 \text{ mm}$

X-ECH-FE MX, X-EKB-FE MX Circuit integrity fastener

Product data

Dimensions

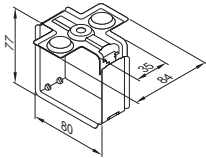
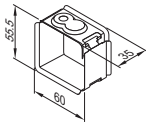
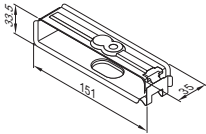
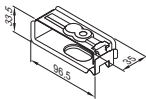
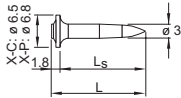
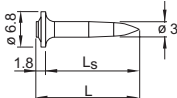
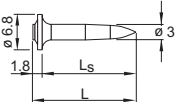
X-ECH-FE 30 MX

X-ECH-FE 15 MX

X-EKB-FE 15 MX

X-EKB-FE 8 MX

X-P 17 B3 MX

X-GHP 18 MX

X-P 17 G3 MX

General information

Material specifications

Galvanized steel sheet	≥ 5 μm zinc coating
X-GHP	Carbon steel, HRC 57.5, zinc coating 2-10 μm
X-P G3 MX	Carbon steel, HRC 57.5, zinc coating 2-10 μm
X-P B3 MX	Carbon steel, HRC 57.5, zinc coating 2-10 μm

Recommended fastening tools

GX 120-ME, GX 3-ME, BX 3-ME

Approval

AbP P-MPA-E-16-010
 AbP P-2401/198/16-MPA BS
 AbP P-1023 DMT DO

Expert review on MLAR application by MPA IBMB Braunschweig

Expert review on nail load in circuit integrity applications by MPA IBMB Braunschweig

Applications



Circuit integrity system (CIS) application with fire rating and load data according to **AbP**

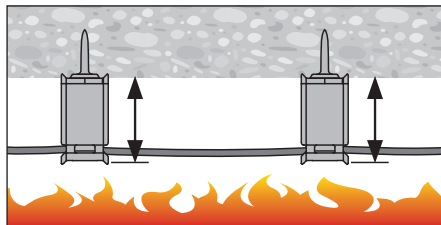

Application to non-circuit integrity cables in escape routes (according to **MLAR**)

Load Data
Recommended loads (ceiling and wall application)

Application →	Escape routes (MLAR)		Circuit integrity system		Spacing a [mm]
	Fastener ↓	Load N_{rec} [kN]	Fire Rating	Cable weight [kg/m]	
X-ECH-FE 30 MX	0.04*	F90	According to AbP documents, fire rating (E30 - E90) and cable weights specific to combination of:	-	$a \leq 600$ mm
X-ECH-FE 15 MX	0.02**				
X-EKB-FE 15 MX	0.02**				
X-EKB-FE 8 MX	0.02**				

* 6.6 kg/m with spacing $a = 600$ mm

** 3.3 kg/m with spacing $a = 600$ mm

- Pre-loading of the elements with load $\geq N_{rec}$ after setting
- All visible failures must be replaced (see “Fastening quality assurance”)

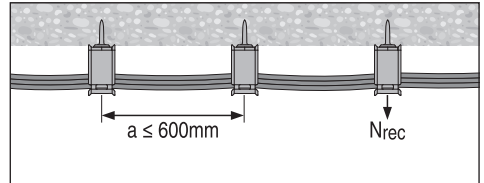
Fastener selection and system recommendation
Thickness of base material

Corrosion Information

The intended use only comprises fastenings which are not directly exposed to external weather conditions or moist atmospheres.

Application requirements
Fastener program

Designation	Item no.
X-ECH-FE 30 MX	2142822
X-ECH-FE 15 MX	2142823
X-EKB-FE 15 MX	2142824
X-EKB-FE 8 MX	2142825

Fastener program

Base material	Nail designation	Shank length Ls [mm]	Nail length L [mm]	Tool
Concrete	X-GHP 18 MX	18	19.8	GX 120-ME
	X-P 17 G3 MX	17	18.8	GX 3-ME
	X-P 17 B3 MX	17	18.8	BX 3-ME

System recommendation

GX 120-ME	Gas can GC 20, GC 21 and GC 22
GX 3-ME	Gas can GC 40, GC 41 and GC 42
BX 3-ME	No gas can required

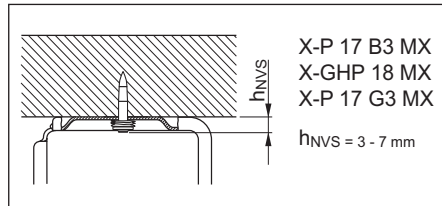
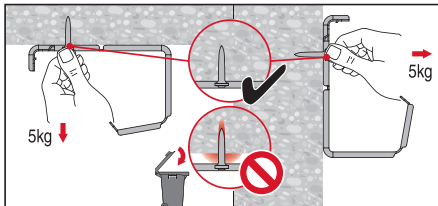
Fastening quality assurance



X-FB, X-DFB, X-EMTC Electrical conduit fastener

Product data

Dimensions

X-FB / X-EMTC

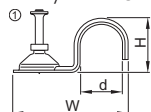

X-DFB

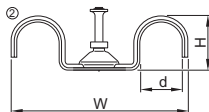

X-FB MX (X-BX/X-EMTC)

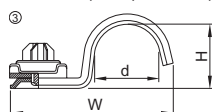

X-GN 27

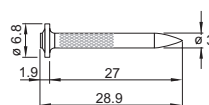

X-GHP 20/24

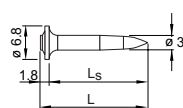

X-U 16/22/27

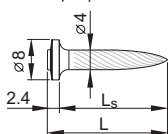

X-EGN 14

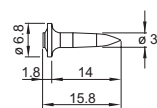

General information

Material specifications

See fastener selection for more details.

Recommended fastening tools

DX 460 F8, DX 460 MX, DX 5 F8,
DX 5 MX, DX 351 F8, DX 351 MX,
GX 120 ME, GX 3 ME, BX 3 ME

See **X-FB (X-DFB/X-EMTC) fastener program** in the next pages and **Tools and equipment chapter** for more details.

X-C 27

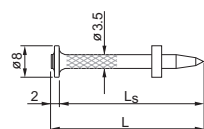

X-P 22/27

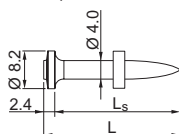

X-P 20/24 G3 MX

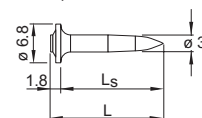

X-S 14 G3 MX

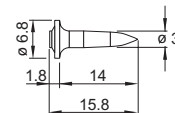

X-P 20/24 B3 MX

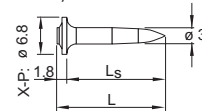

X-S 14 B3 MX

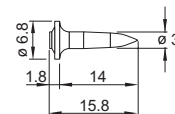

X-C 27 G3 MX

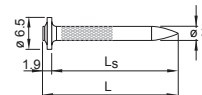

Applications

Example



Load data
Recommended loads

Fastener	Concrete N_{rec} [kN]	Sandlime stone N_{rec} [kN]	Steel N_{rec} [kN]
X-FB / X-DFB (pre-mounted)	0.06	0.06	–
X-FB MX with X-U, X-P or X-C ($L_S = 22-27$ mm)	0.06	0.06	–
X-FB MX with X-U 16 MX	–	–	0.06
X-FB MX with X-P B3 MX, X-P G3 MX or X-GHP ($L_S = 20-24$ mm)	0.02	–	–
X-FB MX with X-C 27 G3 MX or X-GN 27 MX	–	0.06	–
X-FB MX with X-S 14 B3 MX, X-S 14 G3 MX, X-EGN 14 MX or X-U 16 MX	–	–	0.06

Application requirements
Thickness of base material

Concrete

X-U, X-P or X-C: $h_{min} = 80$ mm

**X-P B3 MX, X-P G3 MX,
X-GHP, X-C 27 G3 MX,**
X-GN 27 MX: $h_{min} = 60$ mm

Steel

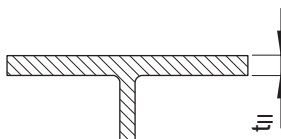
 $t_{II} \geq 4$ mm

Thickness of fastened material
X-FB (X-BX, X-EMTC) To fasten conduits, pipes and tubes of \varnothing 5 mm to 50 mm

Spacing and edge distances

Space fastenings as needed to control sag and maintain alignment.

Corrosion information

These zinc-coated fasteners are not suitable for long-term service outdoors or in otherwise corrosive environments.

 For further detailed information on corrosion see relevant chapter in **Direct Fastening Principles and Technique** section.

Fastener program
Technical information

With pre-mounted nail Designation	Without pre-mounted nail Designation	d [mm]	W [mm]	H [mm]
	③ X-FB 5 MX	5		7
	③ X-FB 6 MX	6		8
	③ X-FB 7 MX	7		9
① X-FB 8-C27	③ X-FB 8 MX	8	31	10
① X-EMTC ^{3/8"}-C27/-U22	③ X-EMTC ^{3/8"} MX	10 (^{3/8"})	33	12
① X-FB 11-C27	③ X-FB 11 MX	11	34	13
① X-EMTC ^{1/2"}-C27/-U22		13 (^{1/2"})		
① X-FB 13-C27	③ X-EMTC ^{1/2"} MX	13 (^{1/2"})	42	15
① X-FB 16-C27	③ X-FB 16 MX	16	44	18
① X-FB 18-C27		18	46	20
① X-EMTC ^{3/4"}-C27/-U22	③ X-EMTC ^{3/4"} MX	19 (^{3/4"})	47	21
① X-FB 20-C27	③ X-FB 20 MX	20	48	22
① X-FB 22-C27	③ X-FB 22 MX	22	50	24
① X-FB 24-C27		24	52	26
① X-FB 25-C27	③ X-FB 25 MX, X-EMTC 1" MX	25 (1")	53	27
① X-EMTC 1"-C27/-U22		25 (1")		
① X-FB 28-C27	③ X-FB 28 MX	28	56	30
① X-FB 32-C27	③ X-FB 32 MX	32	58	34
① X-FB 35-C27		35	64	37
① X-FB 40-C27	③ X-FB 40 MX	40	69	42
① X-FB 50-C27		50	77	52
	③ X-DFB 5 MX	5	47	7
	③ X-DFB 6 MX	6	50	8
	③ X-DFB 7 MX	7	52	9
② X-DFB 8-C27	③ X-DFB 8 MX	8		9.5
② X-DFB 11-C27	③ X-DFB 11 MX	11		12.5
② X-DFB 16-C27	③ X-DFB 16 MX	16	66	15
② X-DFB 18-C27		18	70	18
② X-DFB 20-C27	③ X-DFB 20 MX	20	75	20
② X-DFB 22-C27	③ X-DFB 22 MX	22	79	22
② X-DFB 24-C27	③ X-DFB 25 MX	24	83	24
② X-DFB 25-C27		25		
② X-DFB 28-C27	③ X-DFB 28 MX	28	91	28
② X-DFB 35-C27		35	106	30
② X-DFB 40-C27		40	116	37

Material specification:

- ① + ② Galvanized steel sheet, $f_u = 270\text{-}420\text{ N/mm}^2$, 10–20 μm zinc coating
- ③ Galvanized steel sheet, $f_u = 270\text{-}420\text{ N/mm}^2$, $\geq 5\text{ }\mu\text{m}$ zinc coating

Tools:

DX 460 F8, DX 5 F8, DX 351 F8 for all X-FB/DFB/EMTC with pre-mounted nails
and

DX 460 MX, DX 5 MX, DX 351 MX, GX 120 ME, GX 3 ME, BX 3 ME for X-FB/DFB/EMTC __MX

System recommendation

DX tools: Steel: **6.8/11M yellow or red cartridge**
 Concrete: **6.8/11M yellow cartridge** on soft and tough concrete
 6.8/11M red cartridge on very tough concrete
 Masonry: **6.8/11M green cartridge**

GX 120 tool: **Gas can GC 20, GC1 and GC22**

GX 3 ME tool: **Gas can GC 40, GC 41 and GC 42**

BX 3-ME tool: **No gas can required**

Tool energy adjustment by setting tests on site.

Fastening quality assurance

Nailhead not protruding

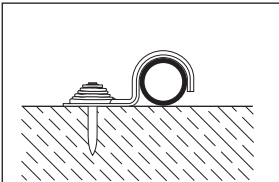

X-FB-E, X-DFB-E Electrical conduit fastener

Product data

Dimensions

X-FB-E

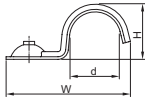

X-DFB-E

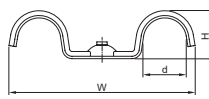

X-GN 20/27

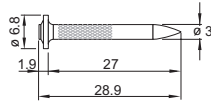

X-GHP 20

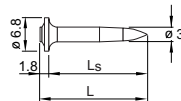

X-C 22/27

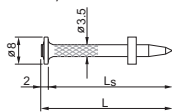

X-P 20 G3 MX

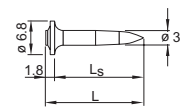

X-P 20 B3 MX

X-C 20 B3 MX

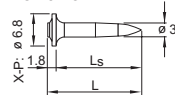

X-C 20/27 G3 MX

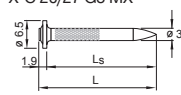

General information

Material specifications

Galvanized steel sheet $f_u = 270-420 \text{ N/mm}^2$
10-20 μm zinc coating

Recommended fastening tools

GX 120-ME, GX 3 ME, BX 3 ME,
DX 351-MX, DX 351-F8 DX 460-MX,
DX 460-F8 DX 5 MX, DX 5 F8

See **X-FB-E fastener program** in the next pages for more details.

Applications

Example



X-FB-E for rigid conduits

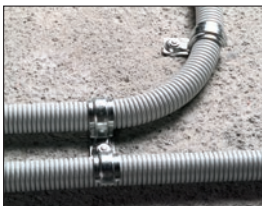

X-FB-E for flexible conduits

Load data

Recommended loads

Fastener	Concrete N_{rec} [kN]	Sandlime stone N_{rec} [kN]
X-FB-E or X-DFB-E with X-GN 20, X-C 20 G3 MX or X-C 20 B3 MX nails	0.02	0.02
X-FB-E or X-DFB-E with X-GN 27 or X-C 27 G3 MX nails	0.06	0.06
X-FB-E or X-DFB-E with X-GHP 20, X-P 20 G3 MX or X-P 20 B3 MX nails	0.02	-
X-FB-E or X-DFB-E with X-C 22/27 nails	0.06	0.06

Application requirements

Thickness of base material

X-GN, X-GHP, X-C G3 MX, X-P G3 MX

X-C B3 MX, X-P B3 MX:

$h_{min} = 60$ mm

X-C:

$h_{min} = 80$ mm

Thickness of fastened material

X-FB-E: To fasten conduits, pipes and tubes of \varnothing 16 mm to 25 mm

X-DFB-E: To fasten conduits, pipes and tubes of \varnothing 20 mm to 25 mm

Spacing and edge distances

Space fastenings as needed to control sag and maintain alignment.

Corrosion information

These zinc-coated fasteners are not suitable for long-term service outdoors or in otherwise corrosive environments.

For further detailed information on corrosion see relevant chapter in **Direct Fastening Principles and Technique** section.

Fastener selection and system recommendation

Fastener program

Designation	Item no.	d [mm]	W [mm]	H [mm]
X-FB-E 16 MX	2112585	16	44	17.5
X-FB-E 20 MX	2112586	20	48	21.5
X-FB-E 25 MX	2112587	25	55	26.5
X-DFB-E 20 MX	2112588	20	80	20
X-DFB-E 25 MX	2112589	25	90	25

Tool selection

X-GN, X-GHP:	GX 120
X-C G3 MX, X-P G3 MX:	GX 3 ME
X-C B3 MX, X-C B3 MX	BX 3 ME
X-C_P8:	DX 351-F8, DX 460-F8, DX 5 F8
X-C_MX:	DX 351-MX, DX 460-MX, DX 5 MX

System recommendation

DX tools	DX 351-F8 DX 460-F8 DX 5 F8	Concrete	6.8/11M yellow cartridge soft and tough concrete
	DX 351-MX DX 460-MX DX 5 MX		6.8/11M red cartridge on very tough concrete
		Masonry	6.8/11M green cartridge
GX tools	GX 120-ME	Gas can GC 20, GC 21 and GC 22	
	GX 3 ME	Gas can GC 40, GC 41 and GC 42	
BX tools	BX 3-ME	No gas can required	

Fastening quality assurance

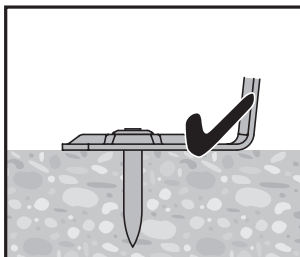

Nail head not protruding

X-UCS MX Universal conduit saddle

Product data

Dimensions

X-UCS MX

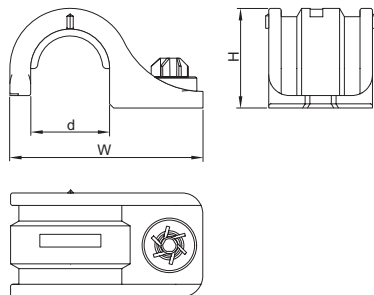

Features and benefits

- Easy and convenient installation to concrete (soft and tough) and sandlime stone base material
- Quick, cost-efficient fastening

General information

Material specification

X-UCS: PE (halogen and silicone free), light grey RAL 7035, free

Applications

Example



- Fastening flexible pipes and pipes with foam insulation for water and heating
- Fastening insulated injection hoses

The intended use only comprises fastenings which are not directly exposed to external weather conditions or moist atmospheres.

Load data

Recommended loads (Base material = concrete)

Fastener	Concrete / Sandlime stone N_{rec} [kN]
X-UCS MX	0.011

Design conditions:

- For pipes fastened with less than 5 fasteners and without any fixed end support, a test load has to be applied to each fastener, see Instruction For Use.
- All visible failures must be replaced.
- Predominantly static loading.
- Valid for soft and tough concrete with strength of $f_{c, cube} = 25-60 \text{ N/mm}^2$, that may contain medium sized aggregate e.g. limestone, pit gravel. please refer to **Concrete Fastener Selection** section in Hilti Direct Fastening Technology Manual (DFTM).
- Valid for sandlime stone.
- Observance of all application limitations and recommendations.
- Long-term behavior of X-UCS MX plastic material considered.

Fastener capacity

Fastening designation	Pipe diameter [mm]	Recommended fastener spacing on ceilings and walls [cm]
X-UCS 19 MX	19.0	80
X-UCS 23 MX	23.0	60
X-UCS 27.5 MX	27.5	40
X-UCS 30.5 MX	30.5	30

Comments:

- Recommended fastener spacing is based on recommended load and average weight of intended pipes during duty

Nail recommendations

For **concrete** base material

Fastening tool	Nail types	Length [mm]	Tip	Shank Ø [mm]	Material	Hardness [HRC]	Coating [µm]
BX 3 ME	X-P B3 MX	20 - 24	Ballistic	3.0	Carbon steel	57.5	Zinc, 2-13 µm
GX 3 ME	X-P G3 MX					57.5	Zinc, 2-13 µm
GX120	X-GHP MX					57.5	Zinc, 2-13 µm

- For the X-UCS MX element, only 20 mm and 24 mm pin lengths are recommended in order to ensure sufficient embedment depth.
- Premium nails (as listed above) are recommended for wall and ceiling application (soft and some tough concrete and sandlime stone, GX/BX tools). For more details regarding nail classification and concrete types, please refer to **Concrete Fastener Selection** section in Hilti Direct Fastening Technology Manual (DFTM).

For **concrete** base material

Fastening tool	Nail types	Length [mm]	Tip	Shank Ø [mm]	Material	Hardness [HRC]	Coating [µm]
BX 3 ME	X-C B3 MX	20 - 24	Cut	3.0	Carbon steel	56.5	Zinc, 2-13 µm
GX 3 ME	X-C G3 MX	20 - 27				56.5	Zinc, 2-13 µm
GX120	X-GN MX	20 - 27				53.5	Zinc, 2-13 µm

- For the X-UCS MX element, only 20 mm, 24 mm and 27 mm pin lengths are recommended in order to ensure sufficient embedment depth.
- Standard nails (as listed above) are recommended for floor application (soft concrete and sandlime stone, GX/BX tools). For more details regarding nail classification and concrete types, please refer to **Concrete Fastener Selection** section in Hilti Direct Fastening Technology Manual (DFTM).

Application requirements

Thickness of base material

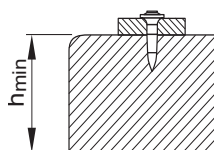

Concrete

**X-P B3 MX, X-P G3 MX,
X-GHP MX, X-C B3 MX,
X-C G3 MX, X-GN MX** $h_{\min} = 60 \text{ mm}$

Edge distance

Min. edge distance = 70 mm

Corrosion information

Zinc-coated nails are not suitable for long-term service outdoors or in otherwise corrosive environments.

For further detailed information on corrosion see relevant chapter in **Direct Fastening Principles and Technique** section.

Fastener selection and system recommendation

Fastener program

Designation	Item no.	d [mm]	W [mm]	H [mm]
X-UCS 19 MX	216565	19.0	46.5	24.0
X-UCS 23 MX	216566	23.0	50.5	28.0
X-UCS 27.5 MX	216567	27.5	55.0	32.5
X-UCS 30.5 MX	216568	30.5	58.0	35.5

Tool selection

X-P B3 MX, X-C B3 MX: BX 3-ME
 X-P G3 MX, X-C G3 MX: GX 3-ME
 X-GHP MX, X-GN MX: GX 120-ME

System recommendation

GX 3-ME Gas can GC 40, GC 41 and GC 42
 GX 120-ME Gas can GC 20, GC 21 and GC 22
 BX 3-ME No gas can required

Fastening quality assurance

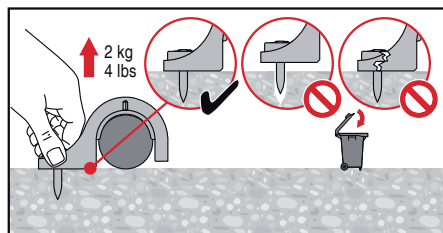
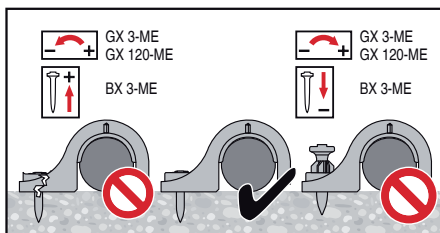

X-UCS-S MX Universal conduit saddle for rigid pipe

Product data

Dimensions

X-UCS-S MX

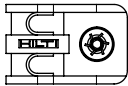
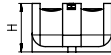
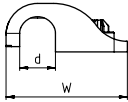

Features and benefits

The X-UCS-S MX enables easy and convenient installation to concrete floor (soft and some tough concrete).

General information

Material specification

X-UCS-S MX: HDPE (halogen and silicon free), light grey RAL 7035

Applications

Example



- Fastening rigid pipes and smooth surface pipes (without foam or grooved protection layer) for water and heating.

The intended use only comprises fastenings which are not directly exposed to external weather conditions or moist atmospheres.

Performance data

Fastener	Concrete / Sandlime stone V_{rec} [kN]
X-UCS-S MX	0.02

Design conditions:

- For pipes fastened with less than 5 fasteners and without any fixed end support, a test load has to be applied to each fastener, see Instruction For Use.
- All visible failures must be replaced.
- Predominantly static loading.
- Valid for soft and some tough concrete with strength of $f_{c,cube} = 25-60 \text{ N/mm}^2$, that may contain medium sized aggregate e.g. limestone, pit gravel. Please refer to **Concrete Fastener Selection** section in Hilti Direct Fastening Technology Manual (DFTM).
- Observance of all application limitations and recommendations.
- Long-term behavior of X-UCS-S MX plastic material considered.

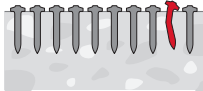

Stick rate estimation		
	Soft Concrete	Tough concrete
X-P B3	85% – 98%	70% – 85%
X-C B3	75% – 90%	55% – 70%

- The stick rate indicates the percentage of nails that were driven correctly to carry a load. Stick rate can vary from the above values depending on job site conditions.

Nail recommendations

For concrete base material							
Fastening tool	Nail types	Length [mm]	Tip	Shank Ø [mm]	Material	Hardness [HRC]	Coating [µm]
BX 3-ME (02)	X-P B3 MX	17 - 24	Long conical	3.0	Carbon steel	57.5	Zinc, 2-10
	X-C B3 MX	20 - 24	Cut			56.5	Zinc, 5-13

Design conditions:

- For more details regarding nail classification and concrete types, please refer to **Concrete Fastener Selection** section in Hilti Direct Fastening Technology Manual (DFTM).

Application requirements

Thickness of base material

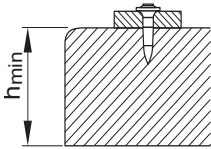

$$h_{\min} = 60 \text{ mm}$$

Edge distance

Min. edge distance = 70 mm

Spacing

- 50-100 cm along the pipe. Adjust spacing as needed to achieve stability of the pipe.
- At pipe turning 90 degree area, please refer to picture for distance between fasteners and orientation of fasteners.

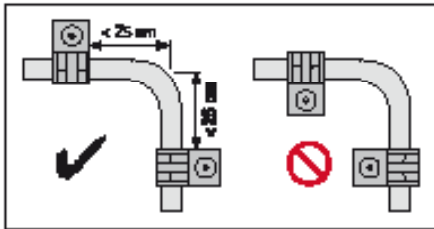

Corrosion information

Zinc-coated nails are not suitable for long-term service outdoors or in otherwise corrosive environments. For further detailed information on corrosion see relevant chapter in **Direct Fastening Principles and Technique** section.

Fastener selection and system recommendation
Fastener program

Designation	Item no.	Pipe Ø [mm]	d [mm]	W [mm]	H [mm]
X-UCS-S 13 MX	2212511	13.0	13.5	45.8	18.3
X-UCS-S 17 MX	2212512	17.0	17.4	49.4	22.2
X-UCS-S 21.5 MX	2212513	21.5	21.9	54.6	26.8
X-UCS-S 27 MX	2212429	27.0	27.4	59.6	32.3

Tool selection

X-P B3 MX, X-C B3 MX: BX 3-ME (02)

System recommendation

BX 3-ME (02): No gas can required

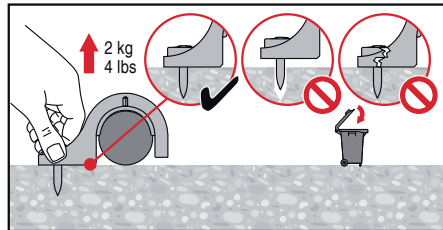
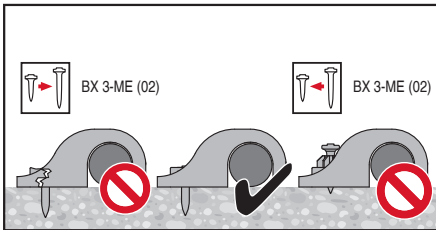
Fastening quality assurance

X-ECT MX, X-UCT MX, X-EKS MX Electrical cable tie and conduit clip fastener

Product data

Dimensions

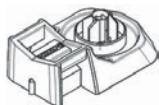
X-ECT MX

X-UCT MX

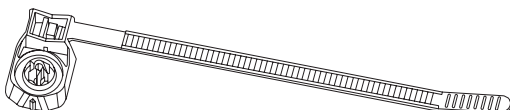
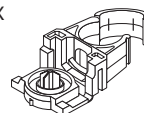
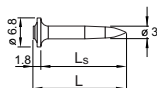
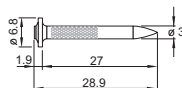
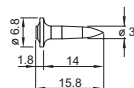
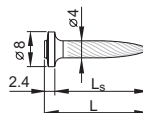
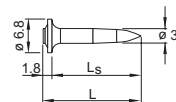
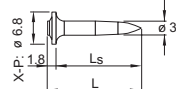
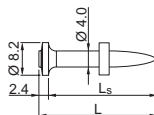
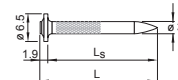
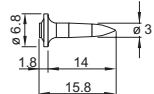
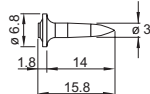
X-EKS MX

X-ECT 40 MX

X-EKSC MX

X-GHP 20/24

X-GN 27

X-EGN 14

X-U 16/22/27

X-P 20/24 G3 MX

X-P 20/24 B3 MX

X-P 22/27

X-C 27 G3 MX

X-S 14 G3 MX

X-S 14 B3 MX

General information

Material specifications

X-ECT and X-EKS: Polyamide (halogen and silicone free), light grey RAL 7035 and PBT (silicone free, flame retardant), stone grey RAL 7030

X-UCT MX: HDPE (halogen and silicone free), light grey RAL 7035

Recommended fastening tools

DX 460 MX, DX 5 MX, DX 351 MX, GX 120 ME, GX 3 ME, BX 3 ME

See **X-ECT MX, X-UCT MX and X-EKS MX fastener program** in the next pages and **Tools and equipment** chapter for more details.

Approvals

CSTB (France)

X-ECT MX, X-EKS MX, X-EKSC MX (all with X-U22 MX nail)

UL (USA)

X-ECT MX

Applications

Examples



Flexible or rigid cable conduits with cable ties



Rigid conduits



Cable conduits or light duty pipes

Load data

Recommended loads

Fastener	Service load ¹⁾ [kN]
X-ECT MX / X-ECT 40 MX, X-UCT MX	0.04
X-EKS MX	0.011

¹⁾ The recommended service load is determined by the serviceability of the plastic part.

Application requirements

Thickness of base material

Concrete

X-U, X-P: $h_{\min} = 80 \text{ mm}$

X-P B3 MX, X-P G3 MX, X-GHP,

X-C 27 G3 MX, X-GN 27 MX: $h_{\min} = 60 \text{ mm}$

Steel

$t_{ij} \geq 4 \text{ mm}$

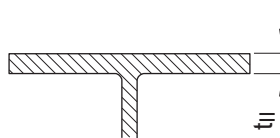

Spacing

50–100 cm along the cable tie. Adjust spacing as needed to achieve stability of cable tie

Corrosion information

These zinc-coated fasteners are not suitable for long-term service outdoors or in otherwise corrosive environments.

For further detailed information on corrosion see relevant chapter in **Direct Fastening Principles and Technique** section.

Fastener selection

 Suitable cables with **X-ECT MX, X-ECT 40 MX** and **X-UCT MX** fastener

Cable type	Cable measure Ø [mm]	No. of cables
NYM 3x1.5	8	14
NYM 5x1.5	10	10

 Suitable conduits with **X-EKS / X-EKSC MX** fastener

Conduit type	Conduit size [mm]	No. of conduits
Plastic conduit	16–40	1

Fastener program

Base material	Cable Holder	Fastening Technology	Nail
Concrete or masonry	X-ECT MX X-EKS MX X-UCT MX	GX 3ME	X-P 20/24 G3 MX X-C 27 G3 MX
		GX 120 ME	X-GHP 20/24 MX X-GN 27 MX
		BX 3 ME	X-P 20/24 B3 MX
	X-ECT MX X-EKS MX	DX 460 MX, DX 5 MX, DX 351 MX	X-U 22/27 MX X-P 22/27 MX
	Steel	X-ECT MX X-EKS MX X-UCT MX	GX 3 ME
GX 120 ME			X-EGN 14 MX
BX 3 ME			X-S 14 B3 MX
X-ECT MX X-EKS MX		DX 460 MX, DX 5 MX, DX 351 MX	X-U 16 MX

X-EKS

Item no.	Designation
285719	X-EKS 16 MX
2105391	X-EKS 19 MX
285720	X-EKS 20 MX
285721	X-EKS 25 MX
285722	X-EKS 32 MX
285723	X-EKS 40 MX

X-EKSC

Item no.	Designation
274083	X-EKSC 16 MX
274086	X-EKSC 20 MX
274087	X-EKSC 25 MX
386469	X-EKSC 32 MX
386470	X-EKSC 40 MX

X-ECT

Item no.	Designation
285709	X-ECT MX
285710	X-ECT UV MX
285711	X-ECT FR MX
432947	X-ECT 40 MX

X-UCT MX

Item no.	Designation
2095183	X-UCT MX

System recommendation

- DX tools: Steel: **6.8/11M yellow or red cartridge**
Concrete: **6.8/11M yellow cartridge** on soft and tough concrete
6.8/11M red cartridge on very tough concrete
Masonry: **6.8/11M green cartridge**

GX 120 tool: **Gas can GC 20, GC21 and GC22**

GX 3 ME tool: **Gas can GC 40, GC 41 and GC 42**

Tool energy adjustment by setting tests on site.

X-UCT-E MX Universal cable tie holder

Product data

Dimensions

X-UCT-E MX

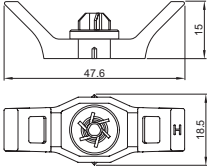

Fasteners for X-UCT-E MX
on **concrete** base material

X-U 22/27 MX

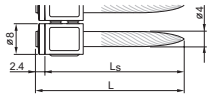

X-C 20/27 MX

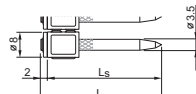

X-U 22/27 P8

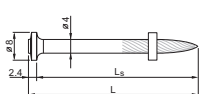

X-C 27 P8

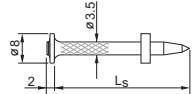

X-GHP 20/24 MX

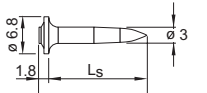

X-GN 20/27 MX

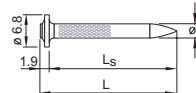

X-P 20/24 G3 MX

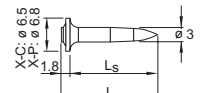

X-C 20/27 G3 MX

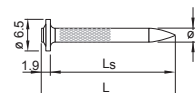

X-P 20/24 B3 MX

X-C 20/24 B3 MX

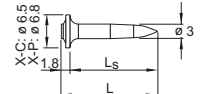

General information

Material specifications:

X-UCT-E MX	PE, light grey RAL 7035
X-U P8, X-U MX	Carbon steel, HRC 58.0, zinc coating 5-20 µm
X-C P8, X-C MX	Carbon steel, HRC 56.5, zinc coating 5-20 µm
X-GHP, X-EGN	Carbon steel, HRC 57.5, zinc coating 2-13 µm
X-GN	Carbon steel, HRC 53.5, zinc coating 2-13 µm
X-P G3 MX,	Carbon steel, HRC 57.5,
X-S G3 MX	zinc coating 2-13 µm
X-C G3 MX	Carbon steel, HRC 56.5,
	zinc coating 2-13 µm
X-P B3 MX,	Carbon steel, HRC 57.5,
X-S B3 MX	zinc coating 2-13 µm
X-C B3 MX	Carbon steel, HRC 56.5,
	zinc coating 2-13 µm

Recommended fastening tools

DX 351 MX, DX 351-F8, GX 120-ME, GX 3-ME, BX 3-ME

Fasteners for X-UCT-E MX on **steel** base material

X-U 16 MX

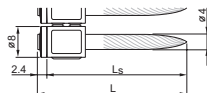

X-U 16 P8

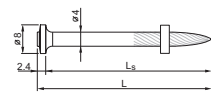

X-EGN 14 MX

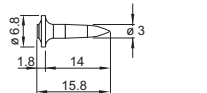

X-S 14 G3 MX / X-S 14 B3 MX

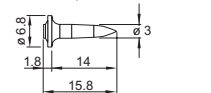

Applications

Examples



X-UCT-E MX with cable ties for two pipes



X-UCT-E MX with cable tie for single pipe

Load data

Recommended loads

Fastener	Service load ¹⁾ [kN]
X-UCT-E MX	0.04
X-UCT-E MX with 1 White cable tie	
X-UCT-E MX with 1 Blue <u>AND</u> 1 Red cable ties	
X-UCT-E MX with <u>EITHER</u> 1 Blue <u>OR</u> 1 Red cable tie	0.02

1) The recommended service load is determined by the serviceability of the plastic parts.

Application requirements

Thickness of base material

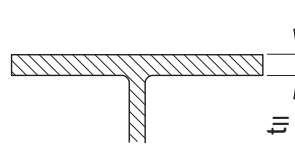
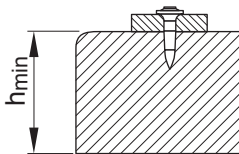

Concrete

X-U MX, X-U P8,
X-C MX, X-C P8

$h_{\min} = 80 \text{ mm}$

X-GHP MX, X-GN MX,
X-P G3 MX, X-C G3 MX,
X-P B3 MX, X-C B3 MX

$h_{\min} = 60 \text{ mm}$

Steel

X-U 16 MX
X-U 16 P8

$t_{II} \geq 6.0 \text{ mm}$

X-EGN 14 MX
X-S 14 B3 MX

$t_{II} \geq 4.0 \text{ mm}$

Spacing and edge distances

Space fastenings (50 – 100 cm) as needed to control sag and maintain alignment of conduits.

Corrosion information

These zinc-coated fasteners are not suitable for long-term service outdoors or in otherwise corrosive environments.

For further detailed information on corrosion see relevant chapter in Direct Fastening Principles and Technique section.

Application limits

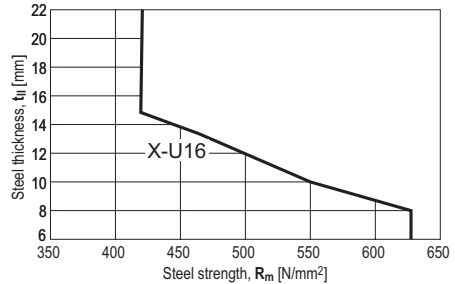
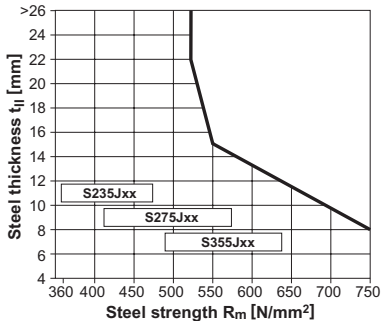

For fastening on steel base material

- X-EGN 14 MX
- X-S 14 B3 MX
- X-S 14 G3 MX

For fastening on steel base material

- X-U 16 MX

Fastener selection and system recommendation

Fastener program

Designation	Item no.	
X-UCT-E MX	2149226	X-UCT-E MX element

Tool selection

X-U MX, X-C MX:	DX 351 MX
X-U P8, X-C P8:	DX 351-F8
X-GHP MX, X-GN MX, X-EGN 14 MX :	GX 120-ME
X-P G3 MX, X-S G3 MX, X-C G3 MX:	GX 3-ME
X-P B3 MX, X-C B3 MX, X-S B3 MX:	BX 3-ME

System recommendation

DX 351 MX, DX 351-F8

Soft concrete: 6.8/11M green,

Tough Concrete: 6.8/11M yellow,

Very tough concrete: 6.8/11M red

GX 120-ME

Gas can GC 20, GC 21 and GC 22

GX 3-ME

Gas can GC 40, GC 41 and GC 42

BX 3-ME

No gas can required

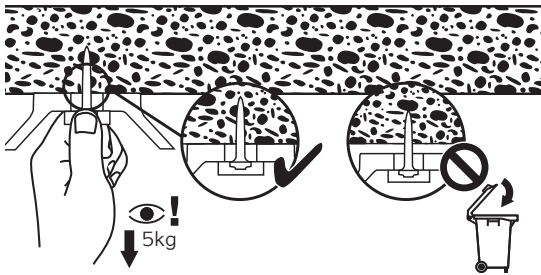
Fastening quality assurance

X-ET Nail for fastening plastic electrical cable tray and junction box

Product data

Dimensions

X-ET UK-H27

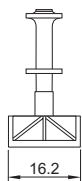
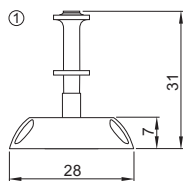

UK-H27

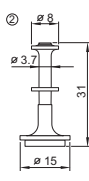

X-ET MX

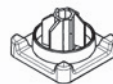

w x l x h = 16.5 x 16.5 x 12 mm

X-GHP 20/24

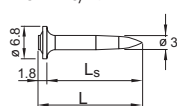

X-GN 27

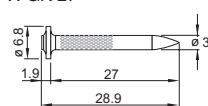

X-EGN 14

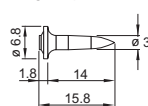

X-U 16/22/27

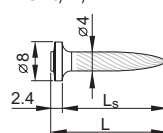

X-P 20/24 G3 MX

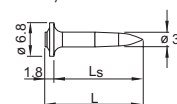

X-P 20/24 B3 MX

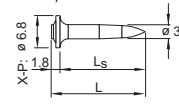

X-P 22/27

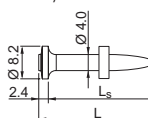

X-C 27 G3 MX

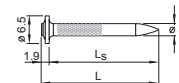

X-S 14 G3 MX

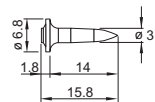

X-S 14 B3 MX

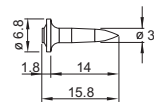

General information

Material specifications

X-ET

Polyethylene

X-ET MX

Polyamide (halogen and silicone free), light grey RAL 7035

and PBT (silicone free, flame retardant), stone grey RAL 7030

Recommended fastening tools

DX 460 MX, DX 5 MX, DX 351 MX, GX 120 ME, GX 3 ME, BX 3 ME

See **X-ET fastener program** in the next pages and **Tools and equipment** chapter for more details.

Applications

Examples



Cable trunking

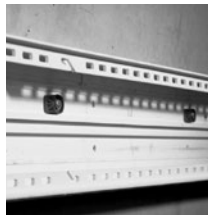

Cable trunking



Junction boxes



Conduits & pipes with metal or textile band

Load data

Recommended load

Fastener	Service load ¹⁾ [kN]
X-ET MX	0.1

¹⁾ The recommended service load is controlled by serviceability of the plastic part.

Application requirements

Thickness of base material

Concrete	
X-U, X-P:	$h_{min} = 80 \text{ mm}$
X-P B3 MX, X-P G3 MX, X-GHP, X-C 27 G3 MX, X-GN 27 MX:	$h_{min} = 60 \text{ mm}$

Steel
$t_{II} \geq 4 \text{ mm}$

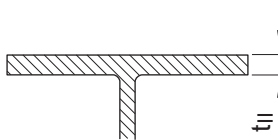

Corrosion information

These zinc-coated fasteners are not suitable for long-term service outdoors or in otherwise corrosive environments.

For further detailed information on corrosion see relevant chapter in **Direct Fastening Principles and Technique** section.

Fastener program

Base material	Cable Holder	Fastening Technology	Nail
Concrete or masonry	X-ET MX	GX 3ME	X-P 20/24 G3 MX X-C 27 G3 MX
		GX 120 ME	X-GHP 20/24 MX X-GN 27 MX
		BX 3 ME	X-P 20/24 B3 MX
	X-ET UK-H27	DX 460 MX, DX 5 MX, DX 351 MX	X-U 22/27 MX X-P 22/27 MX
Steel	X-ET MX	GX 3 ME	X-S 14 G3 MX
		GX 120 ME	X-EGN 14 MX
		BX 3 ME	X-S 14 B3 MX
	X-ET UK-H27	DX 460 MX, DX 5 MX, DX 351 MX	X-U 16 MX

Order information

Fastener	Item no.	Designation
X-ET	251705	X-ET UK-H27
	285718	X-ET MX

Conditions for use:

- No fastenings on ribs
- Underside of trunking must be smooth
- X-ET MX only in pre-drilled holes

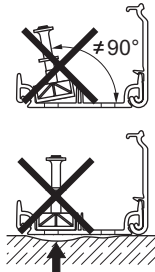

Trunking dimensions:

$t_1 \leq 2 \text{ mm PVC}$

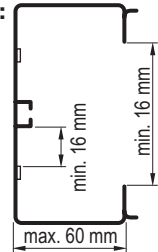

System recommendation

DX tools:	Steel:	6.8/11M yellow or red cartridge
	Concrete:	6.8/11M yellow cartridge on soft and tough concrete 6.8/11M red cartridge on very tough concrete
	Masonry:	6.8/11M green cartridge
GX 120-ME tool:		Gas can GC 20, GC 21 and GC22
GX 3 ME tool:		Gas can GC 40, GC 41 and GC 42
BX 3-ME tool:		No gas can required

Tool energy adjustment by setting tests on site.

GX-WF Wood framing nail

Product data

Dimensions

GX-WF smooth shank nails
(example with D-head)



Available head shapes



d_n = Nom. Nail Diameter
 d_h = Nom. Head Diameter
 l_g = Length of Profile
 l_n = Nom. Nail Length
 l_p = Nom. Point Length
 t_{pen} = Pointside Penetration Depth
 t = Fastening Height

GX-WF profiled shank nails
(example with round head)



Other dimensions

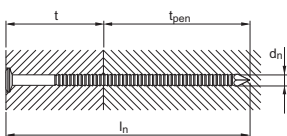
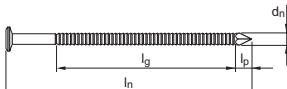

General information

Material specifications

Carbon Steel or Stainless Steel with a minimum tensile strength of 600 N/mm²

Recommended fastening tool

GX 90 WF

Approvals

CE Marking according to EN 14592 (EU)
 BRANZ Appraisal No. 780 (2012) (NZ)

Applications

Examples

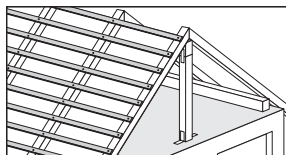

Battens

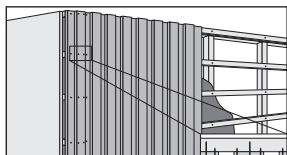

Cladding

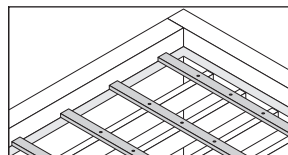

Flat roof

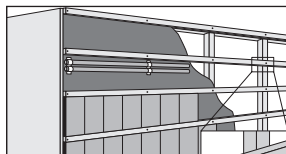

Sub-construction

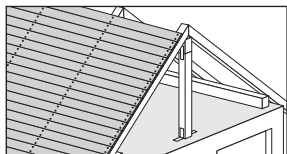

Roof paneling

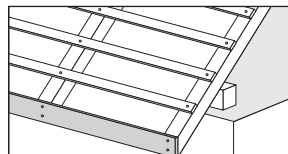

Roof trim

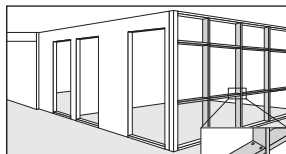

Wall framing

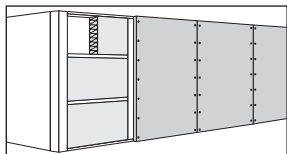

Wall sheeting

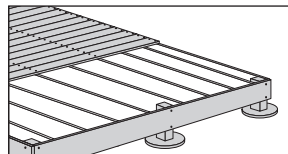

Wood decking

Corrosion information

Suitable Nail Materials depending on Service Class

Corrosion Protection Requirements	EN 1995-1-1 Service Classes related to ISO 2081 ¹⁾		
	1	2	3
Typical average moisture content of the wood specimens	≤ 12%	≤ 20%	> 20%
Designation on package / label			
Requirements for Nails with d ≤ 4 mm	No coating	Fe/Zn 12c	Fe/Zn 25c ²⁾
Suitable GX-WF Materials	All	Galvanized, Hot Dip Galvanized, Stainless	Hot Dip Galvanized, Stainless

1 In particularly corrosive environments, thicker Hot Dip Galvanization or Stainless Steel shall be considered

2 For Hot Dip Galvanized nails typically Fe/Zn 25c is substituted by Z350 according to EN 10147

Note: Certain wood treatments and species, like Oak, Douglas-fir or similar, require stainless steel nails due to the acidity of the wood, typically independent of the Service Class.

Load data

Characteristic yield moment $M_{y,k}$

Nail Type	Available coating / material				Nail Diameter d_n [mm]	Minimum Tensile Strength f_u [N/mm ²]	Characteristic Yield Moment $M_{y,k}$ ^{1,2} [Nmm]
	Bright	Galv	HDG	A2 & A4			

Smooth Nails

GX-WF [I _n] x 2.8 D 34	●	●	●		2.8	600	2617
GX-WF [I _n] x 3.1 D 34	●	●	●		3.1	600	3410

Profiled Nails

GX-WF [I _n] x 2.8 RD 34	●	●			2.8	600	2320
GXWF [I _n] x 2.8 RD 34 2000		●			2.8	600	2743
GX-WF [I _n] x 3.1 RD 34	●	●			3.1	600	3320
GX-WF [I _n] x 2.8 RD 34			●		2.8	600	2130
GX-WF [I _n] x 3.1 RD 34			●		3.1	600	2820
GX-WF [I _n] x 2.8 R/RD 34				●	2.8	600	1960
GX-WF [I _n] x 3.1 RD 34				●	3.1	600	2830

1 Values for smooth nails calculated per EN 1995-1-1 (Eurocode 5), section 8.3.1.1.

2 Values for profiled nails based on testing in accordance with EN 409 and EN 14592

Characteristic Pull-out and Head Pull-through Resistance for wood density of 350 kg/m³

Nail Type	Nail diameter d _n [mm]	Head diameter for calculations d _h [mm]	Characteristic withdrawal parameter ¹ f _{ax,k} [N/mm ²]	Char. Head pull-through parameter ² f _{head,k} [N/mm ²]
Smooth Nails³				
GX-WF [I _n] x 2.8 D 34 (independent of type of corrosion protection)	2.8	7	2.45	8.57
GX-WF [I _n] x 3.1 D 34 (independent of type of corrosion protection)	3.1	7.2	2.45	8.57
Profiled Nails⁴				
GX-WF [I _n] x 2.8 RD 34	2.8	7	7.69	12.54
GX-WF [I _n] x 3.1 RD 34	3.1	7.2	6.77	13.91
GX-WF [I _n] x 2.8 RD 34 galv	2.8	7	7.38	12.54
GX-WF [I _n] x 2.8 RD 34 2000 galv	2.8	7	5.37	14.75
GX-WF [I _n] x 3.1 RD 34 galv	3.1	7.2	6.32	13.91
GX-WF [I _n] x 2.8 RD 34 HDG	2.8	7	8.83	12.54
GX-WF [I _n] x 3.1 RD 34 HDG	3.1	7.2	10.58	13.91
GX-WF [I _n] x 2.8 RD 34 A2 & A4	2.8	7	8.95	12.54
GX-WF [I _n] x 3.1 RD 34 A2 & A4	3.1	7.2	6.26	13.91
GX-WF [I _n] x 2.8 R 34 A2 & A4	2.8	6.4	8.95	15.73

1 Values are valid for penetration depths of 12d (smooth nails) or 8d (profiled nails) respectively. Reduction may factors apply acc. to EN 1995-1-1, section 8.3.2 for smaller penetration depths or for nails installed into wood near the fibre saturation point. The minimum point side penetration depth is 8d (smooth nails) and 6d (profiled nails) respectively. See also section "Application limits"

2 For D-Head nails, the head pull-through parameter f_{head,k} was determined based on testing and calculation using the larger diameter d_h as shown in the Product Data Section. Therefore this value is also given in this table to calculate the correct head pull-through resistance

3 Values for smooth nails are calculated per EN 1995-1-1 section 8.3.2 (6)

4 Values for f_{ax,k} and f_{head,k} for profiled nails based on Initial Type Testing in accordance with EN 14592

Design data in accordance with EN 1995-1-1 (Eurocode 5), Section 8
Design Conditions for Wood to Wood connections:

- Correct installation according to this document, Hilti's printed installation instructions and applicable regulations
- Appropriate nail was selected for the relevant Service Class
- Connection must consist of at least 2 nails

Shear Capacity:

The shear capacity and combined loading capacity has to be calculated according to EN 1995-1-1 or other applicable regulations. The shear capacity depends on the type of connection, the bearing strength of the wood, the slenderness of the nails and the withdrawal strength of the nails. Minimum point side penetration depths are given in the section “Fastener Selection”. Other geometrical connection parameters shall comply with EN-1995-1-1 (EuroCode 5) or other applicable regulations.

Explanation of the failure modes associated with the design parameters presented on this document



Yield Moment $M_{y,k}$

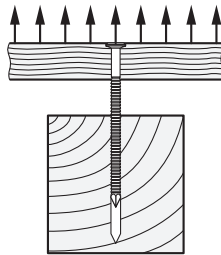

Pull-out $f_{ax,k}$

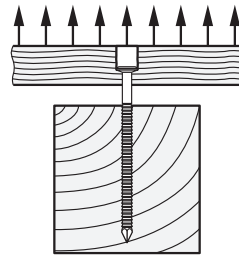

Head pull-through $f_{head,k}$

Calculation example

This calculation should illustrate the characteristic capacity of a common nail type in tension. For a full design, the provisions in EN 1995-1-1 shall be followed using the technical data in this document.

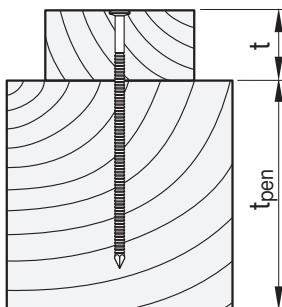

Example:

Characteristic withdrawal capacity for a galvanized profiled nail **GX-WF 90 x 3.1 RD 34 Galv**

Input data:

$t = 20 \text{ mm}$; $t_{\text{pen}} = 70 \text{ mm}$; $kr = 350 \text{ kg/m}^3$

$\Rightarrow f_{\text{ax},k} = 6.32 \text{ N/mm}^2$ and $f_{\text{head},k} = 13.91 \text{ N/mm}^2$ (see **Characteristic Pull out and Pull-through Resistance table**)

GX-WF 90 x 3.1 RD 34 Galv

$l_g = 73.2 \text{ mm}$; $l_p = 4.8 \text{ mm}$; $d_n = 3.1 \text{ mm}$; $d_h = 7.2 \text{ mm}$ (see **Galvanized Nails, Service Class 1&2 table**)

$\Rightarrow l_g + l_p = 78 \text{ mm} > t_{\text{pen}} \Rightarrow$ Embedded part is fully threaded (except tip)

\Rightarrow Only threaded part transfers axial loads: $= t_{\text{pen}} - l_p = 70 \text{ mm} - 4.8 \text{ mm} = 65.2 \text{ mm}$

Calculations:

Pull-out capacity: $f_{\text{ax},k} = 6.32 \times 3.1 \times (70 - 4.8) = 1277 \text{ [N]}$

Head pull-through capacity: $f_{\text{head},k} = 13.91 \times 7.2^2 = 721 \text{ [N]}$

Char. withdrawal capacity:

$F_{\text{ax,Rk}} = \min \{f_{\text{ax},k} \times d_n \times (t_{\text{pen}} - l_p); f_{\text{head},k} \times d_h^2\} = 721 \text{ N}$

\Rightarrow **Head pull-through governs**

Note: Nail Tensile strength doesn't govern for GX-WF nails

Results:

To calculate the **design withdrawal load $F_{\text{ax,Rd}}$** , a safety factor γ_M ($= 1.3$ for connections) and a modification factor k_{mod} for load duration, wood type and moisture, apply per Eurocode 5

\Rightarrow Example: solid timber, Service Class 2, permanent loading $\Rightarrow \gamma_M = 1.3$; $k_{\text{mod}} = 0.6$

$\Rightarrow F_{\text{ax,Rd}} = F_{\text{ax,Rk}} \times k_{\text{mod}} / \gamma_M = 721 \text{ N} \times 0.6 / 1.3 = 333 \text{ N or } 34 \text{ kg}$

Application requirements**Minimum point side penetration depth**

(for nails in tension please consider Characteristic Pull out and Pull-through Resistance table, footnote 1):

- 8 x nail diameter d_n for smooth nails
- 6 x nail diameter d_n for profiled nails

Spacing and edge distance:

Geometrical limitations like spacing and edge distance shall be in compliance with EN 1995-1-1 or other applicable regulations

Fastener Selection and system recommendation

The information in this section complies with EN 1995-1-1 (Eurocode 5) and EN 14592. Item numbers shown in the following tables are for nails only and do not include gas cans.

Where do I use profiled or smooth nails?

In accordance with EN 1995-1-1 the following general rules apply. For non-structural applications, like e.g. battens, other local regulations may apply:

- Profiled nails shall be used for permanent or long-term withdrawal loads > 6 months (see table 2.1 of EN 1995-1-1)
- Smooth nails can only be used for short to medium term withdrawal loads < 6 months (e.g. wind) or for shear loads only

Available head shapes



Other dimensions

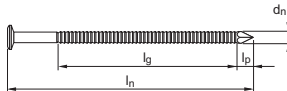

d_n = Nom. Nail Diameter
 d_h = Nom. Head Diameter
 l_g = Length of Profile
 l_n = Nom. Nail Length
 l_p = Nom. Point Length
 t_{pen} = Pointside Penetration Depth
 t = Fastening Height

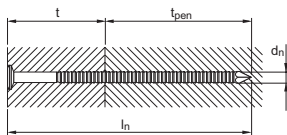

Bright Steel Nails Service Class 1

Item no.	Designation GX-WF (length, l_n) x (dia., d_n)	Head dia., d_h [mm]	Max. fastening height, t [mm]	Min. Length of profile, l_g [mm]	Max. Point length, l_p [mm]
2083658	GX-WF 51x2.8 D 34	7	28	n/a	4.3
2083659	GX-WF 63x2.8 D 34	7	40	n/a	4.3
2083750	GX-WF 70x2.8 D 34	7	47	n/a	4.3
2083751	GX-WF 75x2.8 D 34	7	52	n/a	4.3
2083952	GX-WF 80x2.8 D 34	7	57	n/a	4.3
2083753	GX-WF 80x3.1 D 34	7.2	55	n/a	4.8
2083754	GX-WF 90x3.1 D 34	7.2	65	n/a	4.8
2054064	GX-WF 90x3.1 D 34 2000	7.2	65	n/a	5.4
2083755	GX-WF 51x2.8 RD 34	7	34	34	4.3
2083756	GX-WF 63x2.8 RD 34	7	46	46	4.3
2083757	GX-WF 70x2.8 RD 34	7	53	53	4.3
2083758	GX-WF 75x2.8 RD 34	7	58	58	4.3
2083759	GX-WF 80x2.8 RD 34	7	63	63	4.3
2083760	GX-WF 70x3.1 RD 34	7.2	51	53	4.8
2083761	GX-WF 75x3.1 RD 34	7.2	56	58	4.8
2083762	GX-WF 80x3.1 RD 34	7.2	61	63	4.8
2083763	GX-WF 90x3.1 RD 34	7.2	71	73	4.8

Galvanized Nails, Service Class 1 & 2

Item no.	Designation GX-WF (length, l _n) x (dia., d _n)	Head dia., d _h [mm]	Max. fastening height, t [mm]	Min. Length of profile, l _g [mm]	Max. Point length, l _p [mm]
2083764	GX-WF 51x2.8 D 34 Galv	7	28	n/a	4.3
2083765	GX-WF 63x2.8 D 34 Galv	7	40	n/a	4.3
2083766	GX-WF 70x2.8 D 34 Galv	7	47	n/a	4.3
2083767	GX-WF 75x2.8 D 34 Galv	7	52	n/a	4.3
2083768	GX-WF 80x2.8 D 34 Galv	7	57	n/a	4.3
2083769	GX-WF 75x3.1 D 34 Galv	7.2	50	n/a	4.8
2083770	GX-WF 80x3.1 D 34 Galv	7.2	55	n/a	4.8
2083771	GX-WF 90x3.1 D 34 Galv	7.2	65	n/a	4.8
2054068	GX-WF 90x3.1 D 34 2000 Galv	7.2	65	n/a	5.4
2083772	GX-WF 51x2.8 RD 34 Galv	7	34	34	4.3
2054069	GX-WF 51x2.8 RD 34 3000 Galv	7	34	26	4.9
2083773	GX-WF 63x2.8 RD 34 Galv	7	46	46	4.3
2054270	GX-WF 63x2.8 RD 34 3000 Galv	7	46	38	4.9
2083774	GX-WF 70x2.8 RD 34 Galv	7	53	53	4.3
2083775	GX-WF 75x2.8 RD 34 Galv	7	58	58	4.3
2083776	GX-WF 80x2.8 RD 34 Galv	7	63	63	4.3
2083777	GX-WF 70x3.1 RD 34 Galv	7.2	51	53	4.8
2083778	GX-WF 75x3.1 RD 34 Galv	7.2	56	58	4.8
2083779	GX-WF 80x3.1 RD 34 Galv	7.2	61	63	4.8
2083780	GX-WF 90x3.1 RD 34 Galv	7.2	71	73	4.8

Hot Dip Galvanized Nails, Service Class 1, 2 & 3

Item no.	Designation GX-WF (length, l _n) x (dia., d _n)	Head dia., d _h [mm]	Max. fastening height, t [mm]	Min. Length of profile, l _g [mm]	Max. Point length, l _p [mm]
2083781	GX-WF 51x2.8 D 34 HDG	7	28	n/a	4.3
2083782	GX-WF 63x2.8 D 34 HDG	7	40	n/a	4.3
2083783	GX-WF 75x2.8 D 34 HDG	7	52	n/a	4.3
2083784	GX-WF 75x3.1 D 34 HDG	7.2	50	n/a	4.8
2083785	GX-WF 80x3.1 D 34 HDG	7.2	55	n/a	4.8
2083786	GX-WF 90x3.1 D 34 HDG	7.2	65	n/a	4.8
2083787	GX-WF 51x2.8 RD 34 HDG	7	34	34	4.3
2083788	GX-WF 63x2.8 RD 34 HDG	7	46	46	4.3
2083789	GX-WF 75x2.8 RD 34 HDG	7	58	58	4.3
2083790	GX-WF 80x2.8 RD 34 HDG	7	63	63	4.3
2083791	GX-WF 63x3.1 RD 34 HDG	7.2	44	46	4.8
2083792	GX-WF 75x3.1 RD 34 HDG	7.2	56	58	4.8
2083793	GX-WF 80x3.1 RD 34 HDG	7.2	61	63	4.8
2083794	GX-WF 90x3.1 RD 34 HDG	7.2	71	73	4.8

Stainless Steel Nails, Service Class 1, 2 & 3

Item no.	Designation GX-WF (length, l _n) x (dia., d _n)	Head dia., d _h [mm]	Max. fastening height, t [mm]	Min. Length of profile, l _g [mm]	Max. Point length, l _p [mm]
2006654	GX-WF 51x2.8 RD 34 A2	7	34	34	4.3
2006655	GX-WF 63x2.8 RD 34 A2	7	46	46	4.3
2006656	GX-WF 80x3.1 RD 34 A2	7.2	61	63	4.8
2006657	GX-WF 55x2.8 R 34 A2	6.4	38	38	4.3
2006658	GX-WF 65x2.8 R 34 A2	6.4	48	48	4.3
2006659	GX-WF 80x2.8 R 34 A2	6.4	63	63	4.3
2006660	GX-WF 51x2.8 RD 34 A4	7	34	34	4.3
2006661	GX-WF 63x2.8 RD 34 A4	7	46	46	4.3
2006662	GX-WF 80x3.1 RD 34 A4	7.2	61	63	4.8
2006663	GX-WF 55x2.8 R 34 A4	6.4	38	38	4.3
2006664	GX-WF 65x2.8 R 34 A4	6.4	48	48	4.3
2006665	GX-WF 80x2.8 R 34 A4	6.4	63	63	4.3

Declarations of performance numbers

DoP Number	EN	Product
Hilti-DX-DoP-101	EN 14592	Hilti wood nail GX-WF [In]x2.8 D 34 bright
Hilti-DX-DoP-102	EN 14592	Hilti wood nail GX-WF [In]x2.8 D 34 galv
Hilti-DX-DoP-103	EN 14592	Hilti wood nail GX-WF [In]x2.8 D 34 HDG
Hilti-DX-DoP-104	EN 14592	Hilti wood nail GX-WF [In]x2.8 RD 34 bright
Hilti-DX-DoP-105	EN 14592	Hilti wood nail GX-WF [In]x2.8 RD 34 galv
Hilti-DX-DoP-106	EN 14592	Hilti wood nail GX-WF [In]x2.8 RD 34 3000 galv
Hilti-DX-DoP-107	EN 14592	Hilti wood nail GX-WF [In]x2.8 RD 34 HDG
Hilti-DX-DoP-108	EN 14592	Hilti wood nail GX-WF [In]x2.8 RD 34 A2
Hilti-DX-DoP-109	EN 14592	Hilti wood nail GX-WF [In]x2.8 RD 34 A4
Hilti-DX-DoP-110	EN 14592	Hilti wood nail GX-WF [In]x2.8 R 34 A2
Hilti-DX-DoP-111	EN 14592	Hilti wood nail GX-WF [In]x2.8 R 34 A4
Hilti-DX-DoP-112	EN 14592	Hilti wood nail GX-WF [In]x3.1 D 34 bright
Hilti-DX-DoP-113	EN 14592	Hilti wood nail GX-WF [In]x3,1 D 34 2000
Hilti-DX-DoP-114	EN 14592	Hilti wood nail GX-WF [In]x3.1 D 34 galv
Hilti-DX-DoP-115	EN 14592	Hilti wood nail GX-WF [In]x3,1 D 34 2000 galv
Hilti-DX-DoP-116	EN 14592	Hilti wood nail GX-WF [In]x3.1 D 34 HDG
Hilti-DX-DoP-117	EN 14592	Hilti wood nail GX-WF [In]x3.1 RD 34 A2
Hilti-DX-DoP-118	EN 14592	Hilti wood nail GX-WF [In]x3.1 RD 34 A4
Hilti-DX-DoP-119	EN 14592	Hilti wood nail GX-WF [In]x3.1 RD 34 bright
Hilti-DX-DoP-120	EN 14592	Hilti wood nail GX-WF [In]x3.1 RD 34 galv
Hilti-DX-DoP-121	EN 14592	Hilti wood nail GX-WF [In]x3.1 RD 34 HDG

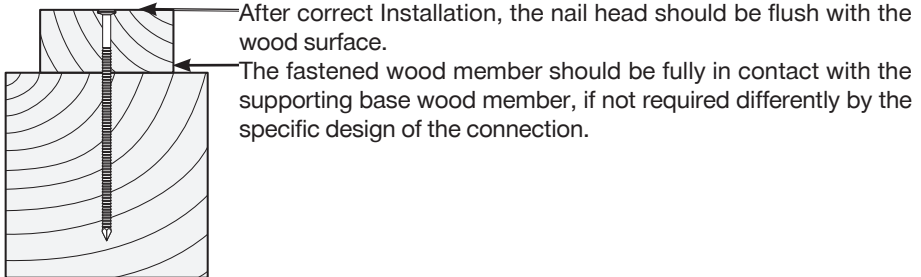
Fastening quality assurance**Fastening Inspection****Fastening wood to wood****Pre-drilling requirements**

Pre-drilling requirements are described in EN 1995-1-1, section 8.3.1.2.

Nails → Approvals

Product	Approval	Country	Application
DNH	ITB AT-15-7696/2016	Poland	Fastening to steel and concrete
DS	ICC-ES ESR-1663	USA	Fastening to steel and concrete
	LR 97/00077(E4)	Global	Fastening to steel
	ITB AT-15-7235/2015	Poland	Fastening to steel and concrete
DX-Kwik	DIBt Z-21.7-670	Germany	Suspended ceiling fastening
	ETA-14/0426	Europe	Fastening to concrete
	IBMB 3041/8171	Germany	Fastening drywall track
	IBMB Gutachten 1498/166/13	Germany	Ceiling hanger fastening
	Rom. Ministry, ICECON: AT 016-01_389-2018	Romania	Fastening to concrete
DX-Kwik X-HS	IBMB Gutachten 1498/166/13	Germany	Ceiling hanger fastening
EDS	DNV-GL 42222-15HH	Global	Fastening to steel, Fastening to steel for shipbuilding
	ICC-ES ESR-1663	USA	Fastening to steel and concrete
	ITB AT-15-7235/2015	Poland	Fastening to steel and concrete
	LR 97/00077(E4)	Global	Fastening to steel
E-Fastener	ETA-16/0301	Europe	Cable fastening
	„Rom. Ministry, ICECON: AT 003-05/500-2016,,	Romania	Cable and conduit fastening
NPH2	BUtgb ATG 1824	Belgium	Metal deck fastening
	Socotec N 1601601R0000004	France	Deck fastening

Product	Approval	Country	Application
S-BT	ABS 16-HS1550085-2-PDA	Global	Fastening to steel, Fastening to steel for off-shore applications, Fastening to steel for shipbuilding
	BV 45116/A2 BV	Global	Fastening to steel, Fastening to steel for shipbuilding
	DNV-GL TAS00000N6	Global	Fastening to steel, Fastening to steel for off-shore applications, Fastening to steel for shipbuilding
S-BT	ITB AT-15-7696/2016	Poland	Fastening to steel and concrete
	LR 16/00063(E1)	Global	Fastening to steel, Fastening to steel for off-shore applications, Fastening to steel for shipbuilding
	Russian Maritime Register	Global	Fastening to steel, Fastening to steel for shipbuilding
	RINA FPE278318CS	Global	Fastening to steel, Fastening to steel for off-shore applications, Fastening to steel for shipbuilding
S-BT-ER / -EF (HC)	ABS 16-HS1550085-2-PDA	Global	Fastening to steel, Fastening to steel for off-shore applications, Fastening to steel for shipbuilding
	BV 45116/A2 BV	Global	Fastening to steel, Fastening to steel for shipbuilding
	DNV-GL TAS00000N6	Global	Fastening to steel, Fastening to steel for off-shore applications, Fastening to steel for shipbuilding
	Russian Maritime Register	Global	Fastening to steel, Fastening to steel for shipbuilding
	RINA FPE278318CS	Global	Fastening to steel, Fastening to steel for off-shore applications, Fastening to steel for shipbuilding

Product	Approval	Country	Application
W10	FM Sprinkler Piper Listings	USA	Sprinkler pipe fastening
	ICC-ES ESR-1663	USA	Fastening to steel and concrete
	UL EX 2258	USA	Sprinkler pipe fastening
	UL EX 2258	Canada	Sprinkler pipe fastening
W6	ICC-ES ESR-1663	USA	Fastening to steel and concrete
Wood nails	BRANZ Appraisal 780 (2012)	New Zealand	Timber joints fastening

Product	Approval	Country	Application
X-BT	ABS 16-HS1545448-PDA	Global	Fastening to steel, Fastening to steel for off-shore applications, Fastening to steel for shipbuilding
	ABS 18-HS1755518-PDA	Global	Fastening to steel, Fastening to steel for off-shore applications, Fastening to steel for shipbuilding
	BV 23498/B0	Global	Fastening to steel, Fastening to steel for shipbuilding
	BV 54054/A0 BV	Global	Fastening to steel, Fastening to steel for shipbuilding
	Canadian Navy	Canada	Fastening to steel, Fastening to steel for shipbuilding
	DNV-GL 12272-10HH	Global	Fastening to steel, Fastening to steel for off-shore applications, Fastening to steel for shipbuilding
	DNV-GL TAS00001SV	Global	Fastening to steel, Fastening to steel for off-shore applications, Fastening to steel for shipbuilding
	ICC-ES ESR-2347 (rev. 09/2018)	USA	Fastening to steel
	ITB AT-15-7696/2016	Poland	Fastening to steel and concrete
	LR 03/00070(E4)	Global	Fastening to steel, Fastening to steel for off-shore applications, Fastening to steel for shipbuilding
	LR 19/00003	Global	Fastening to steel
	UL E 257069	Canada	Grounding
	UL E257069	USA	Grounding
	U.S. Navy 61/09-220	USA	Fastening to steel, Fastening to steel for shipbuilding

Product	Approval	Country	Application
X-BT-ER	ABS 18-HS1755518-PDA	Global	Fastening to steel, Fastening to steel for off-shore applications, Fastening to steel for shipbuilding
	BV 54054/A0 BV	Global	Fastening to steel, Fastening to steel for shipbuilding
	DNV-GL TAS00001SV	Global	Fastening to steel, Fastening to steel for off-shore applications, Fastening to steel for shipbuilding
	LR 19/00003	Global	Fastening to steel
X-BT-GR	ABS 18-HS1755518-PDA	Global	Fastening to steel, Fastening to steel for off-shore applications, Fastening to steel for shipbuilding
	BV 54054/A0 BV	Global	Fastening to steel, Fastening to steel for shipbuilding
	DNV-GL TAS00001SV	Global	Fastening to steel, Fastening to steel for off-shore applications, Fastening to steel for shipbuilding
	LR 19/00003	Global	Fastening to steel
X-BT-MF	ICC ESR 2347	USA	Fastening to steel
X-BT-MR	ABS 18-HS1755518-PDA	Global	Fastening to steel, Fastening to steel for off-shore applications, Fastening to steel for shipbuilding
	BV 54054/A0 BV	Global	Fastening to steel, Fastening to steel for shipbuilding
	DNV-GL TAS00001SV	Global	Fastening to steel, Fastening to steel for off-shore applications, Fastening to steel for shipbuilding
	LR 19/00003	Global	Fastening to steel

Product	Approval	Country	Application
X-BT-MR-N M8	ABS 16-HS1545448-PDA	Global	Fastening to steel, Fastening to steel for off-shore applications, Fastening to steel for shipbuilding
	LR 03/00070(E4)	Global	Fastening to steel, Fastening to steel for off-shore applications, Fastening to steel for shipbuilding
X-BX	UL E217969	USA	Pipe and ventilation duct fastening
	UL E217969	Canada	Pipe and ventilation duct fastening
X-C	IBMB 4850-2018	Germany	Fastening drywall track
	IBMB 4850-2018	Germany	Fastening drywall track
	IBMB 4708/2014	Germany	Fastening drywall track
	IBMB 6536/8173	Germany	Fastening drywall track
	IBMB 6537/8174	Germany	Fastening drywall track
	ICC-ES ESR-1663	USA	Fastening to steel and concrete
X-C B3	ICC-ES ESR-1752	USA	Fastening to steel and concrete
	ITB AT-15-7696/2016	Poland	Fastening to steel and concrete
	„Rom. Ministry, ICECON: AT 016-01_378-2018“	Romania	Fastening to concrete
	IBMB 8300-2016	Germany	Fastening drywall track
X-C G2	IBMB 8302-2016	Germany	Fastening drywall track
	IBMB 8304-2016	Germany	Fastening drywall track
	ICC-ES ESR-1752	USA	Fastening to steel and concrete
	ITB AT-15-7235/2015	Poland	Fastening to steel and concrete
	ICC-ES ESR-1752	USA	Fastening to steel and concrete
X-C G3	ITB AT-15-7235/2015	Poland	Fastening to steel and concrete
	„Rom. Ministry, ICECON: AT 016-01_373-2017“	Romania	Fastening to steel and concrete

Product	Approval	Country	Application
X-CC	CSTB AT 3/16-844	France	Cable and conduit fastening
	ITB AT-15-7696/2016	Poland	Fastening to steel and concrete
	LR 97/00077(E4)	Global	Fastening to steel
	„Rom. Ministry, ICECON: AT 016-01_378-2018“	Romania	Fastening to concrete
X-CF72	ICC-ES ESR-2379	USA	Sill plate fastening
X-CP72	ICC-ES ESR-2379	USA	Sill plate fastening
X-CR	ABS 16-HS1545447-PDA	Global	Fastening to steel
	IBMB 3041/8171	Germany	Fastening drywall track
	ICC-ES ESR-1663	USA	Fastening to steel and concrete
	ITB AT-15-7235/2015	Poland	Fastening to steel and concrete
	LR 97/00078(E4)	Global	Fastening to steel, Fastening to steel for off-shore applications, Fastening to steel for shipbuilding
„Rom. Ministry, ICECON: AT 016-01_378-2018“	Romania	Fastening to concrete	
X-CR 48 (DX-Kwik)	ETA-14/0426	Europe	Fastening to concrete
X-CR 52 (DX-Kwik)	ETA-14/0426	Europe	Fastening to concrete
X-CR M8	DIBt Z-21.7-1512	Germany	Facade fastening
	DIBt Z-21.7-670	Germany	Suspended ceiling fastening
	ICC-ES ESR-2347	USA	Fastening to steel
	ITB AT-15-7235/2015	Poland	Fastening to steel and concrete
	ITB AT-15-7696/2016	Poland	Fastening to steel and concrete
X-CT	ITB AT-15-7696/2016	Poland	Fastening to steel and concrete
X-CX ALH	ICC-ES ESR-2184	USA	Suspended ceiling fastening
X-CX C27	ICC-ES ESR-2184	USA	Suspended ceiling fastening
X-DFB	ITB AT-15-7696/2016	Poland	Fastening to steel and concrete
X-DKH	IBMB 3041/8171	Germany	Fastening drywall track
	ITB AT-15-7696/2016	Poland	Fastening to steel and concrete

Product	Approval	Country	Application
X-DKH48 (DX-Kwik)	DIBt Z-21.7-670	Germany	Suspended ceiling fastening
X-ECC MX	ETA-16/0301	Europe	Cable and conduit fastening
	ITB AT-15-7696/2016	Poland	Fastening to steel and concrete
X-ECH MX	ETA-16/0301	Europe	Cable and conduit fastening
X-ECH	CSTB AT 3/16-844	France	Cable and conduit fastening
	ITB AT-15-7696/2016	Poland	Fastening to steel and concrete
X-ECH/FR-L/-M/-S with X-U37	UL E201485	USA	Cable and conduit fastening
	UL E201485	Canada	Cable and conduit fastening
X-ECH-FE MX	abP P-MPA-E-16-010	Germany	Circuit integrity fastening
	abP P-2401/198/16-MPA-BS	Germany	Circuit integrity fastening
	abP P-1023 DMT DO	Germany	Circuit integrity fastening
X-ECT	CSTB AT 3/16-844	France	Cable and conduit fastening
	ITB AT-15-7235/2015	Poland	Fastening to steel and concrete
X-ECT MX	UL E201485	USA	Cable and conduit fastening
	ETA-16/0301	Europe	Cable and conduit fastening
	UL E201485	Canada	Cable and conduit fastening
X-EF	ABS 16-HS1545445-PDA	Global	Fastening to steel
	LR 97/00077(E4)	Global	Fastening to steel
X-EGN	IBMB 4708/2014	Germany	Fastening drywall track
	IBMB 6536/8173	Germany	Fastening drywall track
	IBMB 6537/8174	Germany	Fastening drywall track
	ICC-ES ESR-1752	USA	Fastening to steel and concrete
	ITB AT-15-7235/2015	Poland	Fastening to steel and concrete
	„Rom. Ministry, ICECON: AT 016-01_388-2018“	Romania	Fastening to steel and concrete

Product	Approval	Country	Application
X-EHS MX	ETA-16/0301	Europe	Cable and conduit fastening
	ITB AT-15-7696/2016	Poland	Fastening to steel and concrete
X-EKB	CSTB AT 3/16-844	France	Cable and conduit fastening
	ETA-16/0301	Europe	Cable and conduit fastening
	ITB AT-15-7696/2016	Poland	Fastening to steel and concrete
X-EKB MX	UL E201485	USA	Cable and conduit fastening
	ETA-16/0301	Europe	Cable and conduit fastening
	UL E201485	Canada	Cable and conduit fastening
X-EKB-FE MX	abP P-MPA-E-16-010	Germany	Circuit integrity fastening
	abP P-2401/198/16-MPA-BS	Germany	Circuit integrity fastening
	abP P-1023 DMT DO	Germany	Circuit integrity fastening
X-EKS MX	ETA-16/0301	Europe	Cable and conduit fastening
	CSTB AT 3/16-844	France	Cable and conduit fastening
X-EKSC MX	ITB AT-15-7235/2015	Poland	Fastening to steel and concrete
	UL E201485	USA	Cable and conduit fastening
	UL E201485	Canada	Cable and conduit fastening
	ETA-16/0301	Europe	Cable and conduit fastening
X-EM	ABS 16-HS1545445-PDA	Global	Fastening to steel
	LR 97/00077(E4)	Global	Fastening to steel
X-EM6/8/10H	ITB AT-15-7235/2015	Poland	Fastening to steel and concrete
X-EMH	„Rom. Ministry, ICECON: AT 016-01_378-2018“	Romania	Fastening to concrete
X-EMTSC	UL E217969	USA	Pipe and ventilation duct fastening
	UL E217969	Canada	Pipe and ventilation duct fastening
X-ENK	ITB AT-15-7235/2015	Poland	Fastening to steel and concrete

Product	Approval	Country	Application
X-ENP	FM 3054498	USA	Deck fastening
X-ENP-19	ABS 16-HS1545445-PDA	Global	Fastening to steel
	DIN EN 1993-1-3/NA	Germany	Deck fastening
	ETA-04/0101	Europe	Deck fastening
	FM 3029102	USA	Form deck fastening
	IAPMO ER 217, Verco Co-listing	USA	Deck fastening
	IAPMO ER 161, ASC Co-listing	USA	Deck fastening
	ICC-ES ESR-1169	USA	Deck fastening
	ICC-ES ESR-2197	USA	Deck fastening
	ICC-ES ESR-2776	USA	Deck fastening
	LR 97/00077(E4)	Global	Fastening to steel
	MLIT 2005	Japan	Deck fastening
SDI	USA	Deck fastening	
UL R 13203	USA	Deck fastening	
X-ENP2K	ABS 16-HS1545445-PDA	Global	Fastening to steel
	BUtgb ATG 1824	Belgium	Metal Deck fastening
	ETA-13/0172	Europe	Deck fastening
	ITB AT-15-7696/2016	Poland	Fastening to steel and concrete
	LR 97/00077(E4)	Global	Fastening to steel
	„Rom. Ministry, ICECON: AT 016-01_378-2018“	Romania	Fastening to concrete
X-EW	ABS 16-HS1545445-PDA	Global	Fastening to steel
	LR 97/00077(E4)	Global	Fastening to steel
X-EW10	FM Sprinkler Piper Listings	USA	Sprinkler pipe fastening
	UL EX 2258	USA	Sprinkler pipe fastening
	UL EX 2258	Canada	Sprinkler pipe fastening
	UL EX 2258	Canada	Sprinkler pipe fastening
X-EW10H	FM 3026695	USA	Fastening to steel
	ICC-ES ESR-2347	USA	Fastening to steel
	UL EX 2258	USA	Sprinkler pipe fastening
	UL EX 2258	Canada	Sprinkler pipe fastening

Product	Approval	Country	Application
X-EW6H	FM 3026695	USA	Fastening to steel
	ICC-ES ESR-2347	USA	Fastening to steel
	UL EX 2258	USA	Sprinkler pipe fastening
	UL EX 2258	Canada	Sprinkler pipe fastening
X-FB	ITB AT-15-7696/2016	Poland	Fastening to steel and concrete
X-FB MX	ETA-16/0301	Europe	Cable and conduit fastening
X-FCM	ABS 15-HS1456396-3-PDA	Global	Fastening to steel, Fastening to steel for off-shore applications, Fastening to steel for shipbuilding
	ABS 16-HS1545445-PDA	Global	Fastening to steel
	ABS 18-HS1785836-PDA	Global	Fastening to steel, Fastening to steel for off-shore applications, Fastening to steel for shipbuilding
	DNV-GL TAS00001UJ	Global	Fastening to steel, Fastening to steel for off-shore applications, Fastening to steel for shipbuilding
	ITB AT-15-7235/2015	Poland	Fastening to steel and concrete
	LR 97/00077(E4)	Global	Fastening to steel
	„Rom. Ministry, ICECON: AT 016-01_378-2018“	Romania	Fastening to concrete

Product	Approval	Country	Application
X-FCM-M	ABS 15-HS1456396-3-PDA	Global	Fastening to steel, Fastening to steel for off-shore applications, Fastening to steel for shipbuilding
	ABS 16-HS1545447-PDA	Global	Fastening to steel
	ABS 16-HS1545448-PDA	Global	Fastening to steel, Fastening to steel for off-shore applications, Fastening to steel for shipbuilding
	ABS 16-HS1550085-2-PDA	Global	Fastening to steel, Fastening to steel for off-shore applications, Fastening to steel for shipbuilding
	BV 23498/B0	Global	Fastening to steel, Fastening to steel for shipbuilding
	BV 45116/A2 BV	Global	Fastening to steel, Fastening to steel for shipbuilding
	DNV-GL 12272-10HH	Global	Fastening to steel, Fastening to steel for off-shore applications, Fastening to steel for shipbuilding
	DNV-GL TAS00000N6	Global	Fastening to steel, Fastening to steel for off-shore applications, Fastening to steel for shipbuilding
	Russian Maritime Register	Global	Fastening to steel, Fastening to steel for shipbuilding
RINA FPE278318CS	Global	Fastening to steel, Fastening to steel for off-shore applications, Fastening to steel for shipbuilding	

Product	Approval	Country	Application
X-FCM-R	ABS 15-HS1456396-3-PDA	Global	Fastening to steel, Fastening to steel for off-shore applications, Fastening to steel for shipbuilding
	ABS 16-HS1545447-PDA	Global	Fastening to steel
	ABS 16-HS1545448-PDA	Global	Fastening to steel, Fastening to steel for off-shore applications, Fastening to steel for shipbuilding
	ABS 16-HS1550085-2-PDA	Global	Fastening to steel, Fastening to steel for off-shore applications, Fastening to steel for shipbuilding
	BV 23498/B0	Global	Fastening to steel, Fastening to steel for shipbuilding
	BV 45116/A2 BV	Global	Fastening to steel, Fastening to steel for shipbuilding
	DNV-GL 12272-10HH	Global	Fastening to steel, Fastening to steel for off-shore applications, Fastening to steel for shipbuilding
	DNV-GL TAS00000N6	Global	Fastening to steel, Fastening to steel for off-shore applications, Fastening to steel for shipbuilding
	LR 03/00070(E4)	Global	Fastening to steel, Fastening to steel for off-shore applications, Fastening to steel for shipbuilding
	LR 97/00078(E4)	Global	Fastening to steel, Fastening to steel for off-shore applications, Fastening to steel for shipbuilding
	LR 19/00003	Global	Fastening to steel
	Russian Maritime Register	Global	Fastening to steel, Fastening to steel for shipbuilding
RINA FPE278318CS	Global	Fastening to steel, Fastening to steel for off-shore applications, Fastening to steel for shipbuilding	

Product	Approval	Country	Application
X-FCM-R HL	ABS 18-HS1785836-PDA	Global	Fastening to steel, Fastening to steel for off-shore applications, Fastening to steel for shipbuilding
	BV 54054/A0 BV	Global	Fastening to steel, Fastening to steel for shipbuilding
X-FCP-F	ABS 15-HS1456396-3-PDA	Global	Fastening to steel, Fastening to steel for off-shore applications, Fastening to steel for shipbuilding
	ABS 16-HS1545447-PDA	Global	Fastening to steel
	ABS 18-HS1785836-PDA	Global	Fastening to steel, Fastening to steel for off-shore applications, Fastening to steel for shipbuilding
	ITB AT-15-7235/2015	Poland	Fastening to steel and concrete
	LR 97/00077(E4)	Global	Fastening to steel
X-FCP-R	ABS 15-HS1456396-3-PDA	Global	Fastening to steel, Fastening to steel for off-shore applications, Fastening to steel for shipbuilding
	ABS 16-HS1545447-PDA	Global	Fastening to steel
	ABS 18-HS1785836-PDA	Global	Fastening to steel, Fastening to steel for off-shore applications, Fastening to steel for shipbuilding
	ITB AT-15-7235/2015	Poland	Fastening to steel and concrete
	LR 97/00077(E4)	Global	Fastening to steel
	LR 97/00078(E4)	Global	Fastening to steel, Fastening to steel for off-shore applications, Fastening to steel for shipbuilding

Product	Approval	Country	Application
X-FCM-R HL	ABS 18-HS1785836-PDA	Global	Fastening to steel, Fastening to steel for off-shore applications, Fastening to steel for shipbuilding
	BV 54054/A0 BV	Global	Fastening to steel, Fastening to steel for shipbuilding
X-FCP-F	ABS 15-HS1456396-3-PDA	Global	Fastening to steel, Fastening to steel for off-shore applications, Fastening to steel for shipbuilding
	ABS 16-HS1545447-PDA	Global	Fastening to steel
	ABS 18-HS1785836-PDA	Global	Fastening to steel, Fastening to steel for off-shore applications, Fastening to steel for shipbuilding
	ITB AT-15-7235/2015	Poland	Fastening to steel and concrete
	LR 97/00077(E4)	Global	Fastening to steel
X-FCP-R	ABS 15-HS1456396-3-PDA	Global	Fastening to steel, Fastening to steel for off-shore applications, Fastening to steel for shipbuilding
	ABS 16-HS1545447-PDA	Global	Fastening to steel
	ABS 18-HS1785836-PDA	Global	Fastening to steel, Fastening to steel for off-shore applications, Fastening to steel for shipbuilding
	ITB AT-15-7235/2015	Poland	Fastening to steel and concrete
	LR 97/00077(E4)	Global	Fastening to steel
	LR 97/00078(E4)	Global	Fastening to steel, Fastening to steel for off-shore applications, Fastening to steel for shipbuilding

Product	Approval	Country	Application
X-FCS	ABS 18-HS1755527-PDA	Global	Fastening to steel, Fastening to steel for off-shore applications, Fastening to steel for shipbuilding
	BV 54054/A0 BV	Global	Fastening to steel, Fastening to steel for shipbuilding
	DNV-GL TAS00001UJ	Global	Fastening to steel, Fastening to steel for off-shore applications, Fastening to steel for shipbuilding
	LR 03/00070(E4)	Global	Fastening to steel, Fastening to steel for off-shore applications, Fastening to steel for shipbuilding
	LR 19/00003	Global	Fastening to steel
	RINA FPE278318CS	Global	Fastening to steel, Fastening to steel for off-shore applications, Fastening to steel for shipbuilding
X-FS	ITB AT-15-7696/2016	Poland	Fastening to steel and concrete
	„Rom. Ministry, ICECON: AT 016-01_378-2018“	Romania	Fastening to concrete
X-G	ITB AT-15-7696/2016	Poland	Fastening to steel and concrete
X-GHP	IBMB 4850-2018	Germany	Fastening drywall track
	IBMB 4850-2018	Germany	Fastening drywall track
	ICC-ES ESR-1752	USA	Fastening to steel and concrete
	„Rom. Ministry, ICECON: AT 016-01_388-2018“	Romania	Fastening to steel and concrete

Product	Approval	Country	Application
X-FCS	ABS 18-HS175527-PDA	Global	Fastening to steel, Fastening to steel for off-shore applications, Fastening to steel for shipbuilding
	BV 54054/A0 BV	Global	Fastening to steel, Fastening to steel for shipbuilding
	DNV-GL TAS00001UJ	Global	Fastening to steel, Fastening to steel for off-shore applications, Fastening to steel for shipbuilding
	LR 03/00070(E4)	Global	Fastening to steel, Fastening to steel for off-shore applications, Fastening to steel for shipbuilding
	LR 19/00003	Global	Fastening to steel
	RINA FPE278318CS	Global	Fastening to steel, Fastening to steel for off-shore applications, Fastening to steel for shipbuilding
X-FS	ITB AT-15-7696/2016	Poland	Fastening to steel and concrete
	„Rom. Ministry, ICECON: AT 016-01_378-2018“	Romania	Fastening to concrete
X-G	ITB AT-15-7696/2016	Poland	Fastening to steel and concrete
X-GHP	IBMB 4850-2018	Germany	Fastening drywall track
	IBMB 4850-2018	Germany	Fastening drywall track
	ICC-ES ESR-1752	USA	Fastening to steel and concrete
	„Rom. Ministry, ICECON: AT 016-01_388-2018“	Romania	Fastening to steel and concrete

Product	Approval	Country	Application
X-GN	IBMB 4850-2018	Germany	Fastening drywall track
	IBMB 4850-2018	Germany	Fastening drywall track
	IBMB 4708/2014	Germany	Fastening drywall track
	IBMB 6536/8173	Germany	Fastening drywall track
	IBMB 6537/8174	Germany	Fastening drywall track
	ICC-ES ESR-1752	USA	Fastening to steel and concrete
	ITB AT-15-7235/2015	Poland	Fastening to steel and concrete
	„Rom. Ministry, ICECON: AT 016-01_388-2018“	Romania	Fastening to steel and concrete
X-GR	ITB AT-15-7696/2016	Poland	Fastening to steel and concrete
X-HS	CSTB AT 3/16-844	France	Cable and conduit fastening
	ITB AT-15-7696/2016	Poland	Fastening to steel and concrete
	LR 97/00077(E4)	Global	Fastening to steel
	„Rom. Ministry, ICECON: AT 016-01_378-2018“	Romania	Fastening to concrete
X-HS U19	ICC-ES ESR-2795	USA	Ceiling hanger fastening
X-HS U32	ICC-ES ESR-2795	USA	Ceiling hanger fastening
X-HS W6/10 U19	FM 3031301	USA	Sprinkler pipe fastening
X-HS W6/10 U19/22/27	UL E217969	USA	Pipe and ventilation duct fastening
	UL E217969	Canada	Pipe and ventilation duct fastening
X-HSN 24	ABS 16-HS1545445-PDA	Global	Fastening to steel
	FM 3054498	USA	Deck fastening
	IAPMO ER 217, Verco Co-listing	USA	Deck fastening
	IAPMO ER 161, ASC Co-listing	USA	Deck fastening
	ICC-ES ESR-1169	USA	Deck fastening
	ICC-ES ESR-2197	USA	Deck fastening
	ICC-ES ESR-2776	USA	Deck fastening
	SDI	USA	Deck fastening
UL R 13203	USA	Deck fastening	

Product	Approval	Country	Application
X-GN	IBMB 4850-2018	Germany	Fastening drywall track
	IBMB 4850-2018	Germany	Fastening drywall track
	IBMB 4708/2014	Germany	Fastening drywall track
	IBMB 6536/8173	Germany	Fastening drywall track
	IBMB 6537/8174	Germany	Fastening drywall track
	ICC-ES ESR-1752	USA	Fastening to steel and concrete
	ITB AT-15-7235/2015	Poland	Fastening to steel and concrete
	„Rom. Ministry, ICECON: AT 016-01_388-2018“	Romania	Fastening to steel and concrete
X-GR	ITB AT-15-7696/2016	Poland	Fastening to steel and concrete
X-HS	CSTB AT 3/16-844	France	Cable and conduit fastening
	ITB AT-15-7696/2016	Poland	Fastening to steel and concrete
	LR 97/00077(E4)	Global	Fastening to steel
	„Rom. Ministry, ICECON: AT 016-01_378-2018“	Romania	Fastening to concrete
X-HS U19	ICC-ES ESR-2795	USA	Ceiling hanger fastening
X-HS U32	ICC-ES ESR-2795	USA	Ceiling hanger fastening
X-HS W6/10 U19	FM 3031301	USA	Sprinkler pipe fastening
X-HS W6/10 U19/22/27	UL E217969	USA	Pipe and ventilation duct fastening
	UL E217969	Canada	Pipe and ventilation duct fastening
X-HSN 24	ABS 16-HS1545445-PDA	Global	Fastening to steel
	FM 3054498	USA	Deck fastening
	IAPMO ER 217, Verco Co-listing	USA	Deck fastening
	IAPMO ER 161, ASC Co-listing	USA	Deck fastening
	ICC-ES ESR-1169	USA	Deck fastening
	ICC-ES ESR-2197	USA	Deck fastening
	ICC-ES ESR-2776	USA	Deck fastening
	SDI	USA	Deck fastening
UL R 13203	USA	Deck fastening	

Product	Approval	Country	Application
X-HS-W	CSTB AT 3/16-844	France	Cable and conduit fastening
	ITB AT-15-7696/2016	Poland	Fastening to steel and concrete
X-HVB	ETA-15/0876	Europe	Composite shear connection
	ITB AT-15-7235/2015	Poland	Fastening to steel and concrete
X-IE	ITB AT-15-7696/2016	Poland	Fastening to steel and concrete
	Socotec N 1601601R0000003	France	Insulation fastening
X-IE-G	Socotec N 180668080000010	France	Insulation fastening
XI-FV	ETA-17/0304	Europe	Insulation fastening (ETICS)
X-M10	ITB AT-15-7235/2015	Poland	Fastening to steel and concrete
X-M6	„Rom. Ministry, ICECON: AT 016-01_378-2018“	Romania	Fastening to concrete
X-M6 B3	ITB AT-15-7235/2015	Poland	Fastening to steel and concrete
X-M6 G2	ITB AT-15-7235/2015	Poland	Fastening to steel and concrete
X-M6 G3	„Rom. Ministry, ICECON: AT 016-01_373-2017“	Romania	Fastening to steel and concrete
X-M6 G3	ITB AT-15-7235/2015	Poland	Fastening to steel and concrete
X-M6H	IBMB 3041/8171	Germany	Fastening drywall track
	ITB AT-15-7696/2016	Poland	Fastening to steel and concrete
X-M8	ITB AT-15-7235/2015	Poland	Fastening to steel and concrete
X-M8H	DIBt Z-21.7-670	Germany	Suspended ceiling fastening
	IBMB 3041/8171	Germany	Fastening drywall track
	ITB AT-15-7235/2015	Poland	Fastening to steel and concrete
	ITB AT-15-7696/2016	Poland	Fastening to steel and concrete
X-MGR	ITB AT-15-7696/2016	Poland	Fastening to steel and concrete
X-NK	ITB AT-15-7235/2015	Poland	Fastening to steel and concrete

Product	Approval	Country	Application
X-P	IBMB 19210-2017	Germany	Fastening drywall track
	IBMB 19211-2017	Germany	Fastening drywall track
	IBMB 19212-2017	Germany	Fastening drywall track
	ICC-ES ESR-2269	USA	Fastening to steel and concrete
	„Rom. Ministry, ICECON: AT 016-01_378-2018“	Romania	Fastening to concrete
	VHT PZ-809-15	Germany	Deflection head fastening
X-P B3	IBMB 8300-2016	Germany	Fastening drywall track
	IBMB 8302-2016	Germany	Fastening drywall track
	IBMB 8304-2016	Germany	Fastening drywall track
	ETA-16/0301	Europe	Cable and conduit fastening
	ICC-ES ESR-1752	USA	Fastening to steel and concrete
	ITB AT-15-7235/2015	Poland	Fastening to steel and concrete
X-P G2	ICC-ES ESR-1752	USA	Fastening to steel and concrete
	ITB AT-15-7235/2015	Poland	Fastening to steel and concrete
X-P G3	ICC-ES ESR-1752	USA	Fastening to steel and concrete
	ETA-16/0301	Europe	Cable and conduit fastening
	ITB AT-15-7235/2015	Poland	Fastening to steel and concrete
	„Rom. Ministry, ICECON: AT 016-01_373-2017“	Romania	Fastening to steel and concrete
X-PGR	ITB AT-15-7696/2016	Poland	Fastening to steel and concrete
X-PN	ICC-ES ESR-3059	USA	Plywood fastening
	ITB AT-15-7696/2016	Poland	Fastening to steel and concrete
X-PN 37 G2	ICC-ES ESR-3059	USA	Plywood fastening
X-PN 37 G3	ICC-ES ESR-3059	USA	Plywood fastening

Product	Approval	Country	Application
X-R14	ABS 16-HS1545447-PDA	Global	Fastening to steel
	DIBt Z-14.4-766	Germany	Glas facade fastening
	ITB AT-15-7235/2015	Poland	Fastening to steel and concrete
	LR 97/00078(E4)	Global	Fastening to steel, Fastening to steel for off-shore applications, Fastening to steel for shipbuilding
X-S	ICC-ES ESR-1752	USA	Fastening to steel and concrete
	ITB AT-15-7235/2015	Poland	Fastening to steel and concrete
X-S B3	ICC-ES ESR-1752	USA	Fastening to steel and concrete
X-S G3	ICC-ES ESR-1752	USA	Fastening to steel and concrete
X-S G3	„Rom. Ministry, ICECON: AT 016-01_373-2017“	Romania	Fastening to steel and concrete
X-ST-GR	ABS 16-HS1545447-PDA	Global	Fastening to steel
	ICC-ES ESR-2347	USA	Fastening to steel
	ITB AT-15-7235/2015	Poland	Fastening to steel and concrete
	LR 97/00078(E4)	Global	Fastening to steel, Fastening to steel for off-shore applications, Fastening to steel for shipbuilding
X-SW	ITB AT-15-7696/2016	Poland	Fastening to steel and concrete
	„Rom. Ministry, ICECON: AT 016-01_378-2018“	Romania	Fastening to concrete

Product	Approval	Country	Application
X-U	ABS 16-HS1545445-PDA	Global	Fastening to steel
	DIBt Z-14.4-517	Germany	Fastening to steel
	DNV-GL 42222-15HH	Global	Fastening to steel, Fastening to steel for shipbuilding
	IBMB 2006/2011	Germany	Fastening drywall track
	IBMB 4708/2014	Germany	Fastening drywall track
	IBMB 6536/8173	Germany	Fastening drywall track
	IBMB 6537/8174	Germany	Fastening drywall track
	ICC-ES ESR-2269	USA	Fastening to steel and concrete
	ITB AT-15-7696/2016	Poland	Fastening to steel and concrete
	LR 97/00077(E4)	Global	Fastening to steel
	„Rom. Ministry, ICECON: AT 016-01_378-2018“	Romania	Fastening to concrete
	VHT PZ-809-15	Germany	Fastening drywall track
X-U15	ICC-ES ESR-2269	USA	Fastening to steel and concrete
X-U16 S12	ETA-16/0082	Europe	Siding
X-UCT	ITB AT-15-7235/2015	Poland	Fastening to steel and concrete
X-W6	ICC-ES ESR-1663	USA	Fastening to steel and concrete

Approvals → Nails

Approval	Product	Country	Application
abP P-MPA-E-16-010	X-ECH-FE MX, X-EKB-FE MX	Germany	Circuit integrity fastening
abP P-2401/198/16-MPA-BS	X-ECH-FE MX, X-EKB-FE MX	Germany	Circuit integrity fastening
abP P-1023 DMT DO	X-ECH-FE MX, X-EKB-FE MX	Germany	Circuit integrity fastening
ABS 15-HS1456396-3-PDA	X-FCM, X-FCM-R, X-FCM-M, X-FCP-R, X-FCP-F	Global	Fastening to steel, Fastening to steel for off-shore applications, Fastening to steel for shipbuilding
ABS 16-HS1545445-PDA	EDS, X-U, X-ENP2K, X-ENP-19, X-HSN 24, X-EM, X-EW, X-EF, X-FCM	Global	Fastening to steel
ABS 16-HS1545447-PDA	X-CR, X-R14, X-CRM, X-CRW, X-ST-GR, X-FCM-R, X-FCM-M, X-FCP-R, X-FCP-F	Global	Fastening to steel
ABS 16-HS1545448-PDA	X-BT, X-BT-ER, X-BT-MR-N M8, X-FCM-M, X-FCM-R	Global	Fastening to steel, Fastening to steel for off-shore applications, Fastening to steel for shipbuilding
ABS 16-HS1550085-2-PDA	S-BT, S-BT-ER / -EF (HC), X-FCM-M, X-FCM-R	Global	Fastening to steel, Fastening to steel for off-shore applications, Fastening to steel for shipbuilding
ABS 18-HS1755518-PDA	X-BT-MR, X-BT-GR, X-BT-ER	Global	Fastening to steel, Fastening to steel for off-shore applications, Fastening to steel for shipbuilding
ABS 18-HS1785836-PDA	X-FCM-R HL, X-FCM, X-FCP-R, X-FCP-F	Global	Fastening to steel, Fastening to steel for off-shore applications, Fastening to steel for shipbuilding
ABS 18-HS1755527-PDA	X-FCS	Global	Fastening to steel, Fastening to steel for off-shore applications, Fastening to steel for shipbuilding
BRANZ Appraisal 780 (2012)	Wood nails	New Zealand	Timber joints fastening

Approval	Product	Country	Application
BUtgb ATG 1824	NPH2, X-ENP2K	Belgium	Metal deck fastening
BV 23498/B0	X-BT, X-FCM-M, X-FCM-R	Global	Fastening to steel, Fastening to steel for shipbuilding
BV 45116/A2 BV	S-BT, S-BT-ER / -EF (HC), X-FCM-M, X-FCM-R	Global	Fastening to steel, Fastening to steel for shipbuilding
BV 54054/A0 BV	X-BT-MR, X-BT-GR, X-BT-ER, X-FCS, X-FCM-R HL	Global	Fastening to steel, Fastening to steel for shipbuilding
Canadian Navy	X-BT	Canada	Fastening to steel, Fastening to steel for shipbuilding
CNBOP 3009/2015	E-Fasteners	Poland	Cable and conduit fastening
CNBOP_AT-0605-0430- 2014	E-Fasteners	Poland	Cable and conduit fastening
CNBOP_AT-0602-0102- 2009-2014	E-Fasteners	Poland	Cable and conduit fastening
CSTB AT 3/16-844	X-EKB, X-ECH, X-ECT, X-EKS, X-EKSC, X-CC, X-HS, X-HS-W	France	Cable and conduit fastening
DIBt Z-14.4-517	X-U	Germany	Fastening to steel
DIBt Z-14.4-766	X-R14	Germany	Glas facade fastening
DIBt Z-21.7-1512	X-CR M8, X-CR 48	Germany	Facade fastening
DIBt Z-21.7-670	X-M8H, X-CR M8, X-DKH48 (DX-Kwik)	Germany	Suspended ceiling fastening
DIN EN 1993-1-3/NA	X-ENP-19 Lateral buckling	Germany	Deck fastening
DNV-GL 12272-10HH	X-BT, X-BT-ER, X-FCM-M, X-FCM-R	Global	Fastening to steel, Fastening to steel for off-shore applications, Fastening to steel for shipbuilding
DNV-GL 42222-15HH	X-U, EDS	Global	Fastening to steel, Fastening to steel for shipbuilding
DNV-GL TAS00000N6	S-BT, S-BT-ER / -EF (HC), X-FCM-M, X-FCM-R	Global	Fastening to steel, Fastening to steel for off-shore applications, Fastening to steel for shipbuilding
DNV-GL TAS00001SV	X-BT-GR, X-BT-MR, X-BT-ER	Global	Fastening to steel, Fastening to steel for off-shore applications, Fastening to steel for shipbuilding

Approval	Product	Country	Application
DNV-GL TAS00001UJ	X-FCM, X-FCS	Global	Fastening to steel, Fastening to steel for off-shore applications, Fastening to steel for shipbuilding
ETA-04/0101	X-ENP-19	Europe	Deck fastening
ETA-13/0172	X-ENP2K, DX 76 PTR	Europe	Deck fastening
ETA-14/0426	X-CR 48 P8 S15 (DX-Kwik), X-CR 52 P8 S15 (DX-Kwik)	Europe	Fastening to concrete
ETA-15/0876	X-HVB	Europe	Composite shear connection
ETA-16/0082	X-U16 S12	Europe	Siding
ETA-16/0301	X-P 20 B3/G3, X-P 24 B3/G3, X-EKB MX, X-ECT MX, X-ECH MX, X-EKS MX, X-EKSC MX, X-(D)FB MX, X-ECC MX, X-EHS MX	Europe	Cable and conduit fastening
ETA-17/0304	XI-FV	Europe	Insulation fastening (ETICS)
FM 3026695	X-EW6H, X-EW10H	USA	Fastening to steel
FM 3029102	X-ENP-19	USA	Form deck fastening
FM 3031301	X-HS W6/10 U19	USA	Sprinkler pipe fastening
FM 3054498	X-ENP, X-HSN 24	USA	Deck fastening
FM Sprinkler pipe fastening Listings	W10, X-EW10	USA	Sprinkler pipe fastening
IAPMO ER 217, Verco Co-listing	X-ENP-19, X-HSN 24	USA	Deck fastening
IAPMO ER 161, ASC Co-listing	X-ENP-19, X-HSN 24	USA	Deck fastening
IBMB 4850-2018	X-GN, X-GHP, X-C	Germany	Fastening drywall track
IBMB 4850-2018	X-GN, X-GHP, X-C	Germany	Fastening drywall track
IBMB 2006/2011	X-U	Germany	Fastening drywall track
IBMB 3041/8171	DX-Kwik, X-CR, X-DKH, X-M6H, X-M8H	Germany	Fastening drywall track
IBMB 19210-2017	X-P, DX5, GX3, Knauf-Trockenbauwände	Germany	Fastening drywall track
IBMB 19211-2017	X-P, DX5, GX3, Siniat-Trockenbauwände	Germany	Fastening drywall track
IBMB 19212-2017	X-P, DX5, GX3, Rigips-Trockenbauwände	Germany	Fastening drywall track
IBMB 8300-2016	X-P B3, X-C B3 Knauf-Trockenbauwände	Germany	Fastening drywall track

Approval	Product	Country	Application
IBMB 8302-2016	X-P B3, X-C B3 Siniat-Trockenbauwände	Germany	Fastening drywall track
IBMB 8304-2016	X-P B3, X-C B3 Rigips-Trockenbauwände	Germany	Fastening drywall track
IBMB 4708/2014	X-GN, X-EGN, X-C, X-U, Rigips-Trockenbauwände	Germany	Fastening drywall track
IBMB 6536/8173	X-GN, X-EGN, X-C, X-U, Knauf-Trockenbauwände	Germany	Fastening drywall track
IBMB 6537/8174	X-GN, X-EGN, X-C, X-U, Siniat-Trockenbauwände	Germany	Fastening drywall track
IBMB Gutachten 1498/166/13	DX-Kwik X-HS	Germany	Ceiling hanger fastening
ICC-ES ESR-1169	X-ENP-19, X-HSN 24	USA	Deck fastening
ICC-ES ESR-1663	EDS, DS, X-C, X-CR, X-W6, W10	USA	Fastening to steel and concrete
ICC-ES ESR-1752	X-GN, X-GHP, X-EGN, X-S, X-C, X-P G3, X-P G2, X-S G3, X-C G3, X-C G2, X-C B3, X-S B3, X-P B3	USA	Fastening to steel and concrete
ICC-ES ESR-2184	X-CX ALH, X-CX C27	USA	Suspended ceiling fastening
ICC-ES ESR-2197	X-ENP-19, X-HSN 24	USA	Deck fastening
ICC-ES ESR-2269	X-U, X-U15, X-P	USA	Fastening to steel and concrete
ICC-ES ESR-2347	X-EW6H, X-EW10H; X-CR M8, X-BT, X-ST-GR	USA	Fastening to steel
ICC-ES ESR-2379	X-CF72, X-CP72	USA	Sill plate fastening
ICC-ES ESR-2776	X-ENP-19, X-HSN 24	USA	Deck fastening
ICC-ES ESR-2795	X-HS U19, X-HS U32	USA	Ceiling hanger fastening
ICC-ES ESR-3059	X-PN, X-PN 37 G2, X-PN 37 G3	USA	Plywood fastening
ITB AT-15-7235/2015	X-CR, X-ENK, X-NK, X-CR M8, X-ECT, X-UCT, X-EKS, X-EKSC, DS, EDS, X-EGN, X-EM6/8/10H, X-FCM, X-IE, X-FCP-R, X-FCP-F, X-GN, X-M8, X-M10, X-M8H, X-P B3, X-P G3, X-P G2, X-C B3, X-C G3, X-C G2, X-M6 B3, X-M6 G3, X-M6 G2, X-S, X-ST-GR, X-R14	Poland	Fastening to steel and concrete

Approval	Product	Country	Application
ITB AT-15-7696/2016	X-U, X-ENP2K, X-C, X-FS, X-SW, X-IE, X-CT, X-BT, X-GR, X-PGR, X-MGR, X-G, X-CR M8, X-HS, X-EHS, X-HS-W, X-CC, X-ECC, X-EKB, X-ECH, X-FB, X-DFB, X-M6H, X-M8H, DNH, X-DKH, X-PN, S-BT	Poland	Fastening to steel and concrete
LR 03/00070(E4)	X-BT, X-BT-ER, X-BT-MR-N M8, X-FCM-R, X-FCS	Global	Fastening to steel, Fastening to steel for off-shore applications, Fastening to steel for shipbuilding
LR 97/00077(E4)	X-U, EDS, DS, X-ENP-19, X-ENP2K, X-EM, X-EW, X-EF, X-HS, X-CC, X-FCM, X-FCP-R, X-FCP-F	Global	Fastening to steel
LR 97/00078(E4)	X-CR, X-R14, X-CRM, X-ST-GR, X-FCM-R, X-FCP-R	Global	Fastening to steel, Fastening to steel for off-shore applications, Fastening to steel for shipbuilding
LR 16/00063(E1)	S-BT	Global	Fastening to steel, Fastening to steel for off-shore applications, Fastening to steel for shipbuilding
LR 19/00003	X-BT-GR, X-BT-MR, X-BT-ER, X-FCM-R, X-FCS	Global	Fastening to steel
MLIT 2005	X-ENP-19	Japan	Deck fastening
„Rom. Ministry, ICECON: AT 016-01_373-2017“	X-C G3, X-P G3, X-S G3, X-M6 G3	Romania	Fastening to steel and concrete
Rom. Ministry, ICECON: AT 003-05/500-2016	E-fasteners	Romania	Cable and conduit fastening
„Rom. Ministry, ICECON: AT 016-01_378-2018“	X-U, X-C, X-P, X-CR, X-CRM, X-M6, X-ENP2K, X-EMH, X-FCM, X-SW, X-FS, X-HS, X-CC, etc.	Romania	Fastening to concrete
„Rom. Ministry, ICECON: AT 016-01_388-2018“	X-GN, X-EGN, X-GHP	Romania	Fastening to steel and concrete
„Rom. Ministry, ICECON: AT 016-01_389-2018“	DX-Kwik	Romania	Fastening to concrete

Approval	Product	Country	Application
Russian Maritime Register	S-BT, S-BT-ER / -EF (HC), X-FCM-M, X-FCM-R	Global	Fastening to steel, Fastening to steel for shipbuilding
SDI	X-ENP-19	USA	Deck fastening
SDI	X-HSN 24	USA	Deck fastening
Socotec N 1601601R0000003	X-IE	France	Insulation fastening
Socotec N 1601601R0000004	NPH2	France	Deck fastening
Socotec N 180668080000010	X-IE-G	France	Insulation fastening
U.S. Navy 61/09-220	X-BT	USA	Fastening to steel, Fastening to steel for shipbuilding
UL E201485	X-ECH/FR-L/-M/-S with X-U37, X-EKB MX, X-ECT MX, X-EKSC MX	USA	Cable and conduit fastening
UL E201485	X-ECH/FR-L/-M/-S with X-U37, X-EKB MX, X-ECT MX, X-EKSC MX	Canada	Cable and conduit fastening
UL E217969	X-HS W6/10 U19/22/27, X-RH, X-EMTSC, X-BX	USA	Pipe and ventilation duct fastening
UL E217969	X-HS W6/10 U19/22/27, X-RH, X-EMTSC, X-BX	Canada	Pipe and ventilation duct fastening
UL EX 2258	W10, X-EW10, X-EW6H, X-EW10H	USA	Sprinkler pipe fastening
UL EX 2258	W10, X-EW10, X-EW6H, X-EW10H	Canada	Sprinkler pipe fastening
UL R 13203	X-ENP-19, X-HSN 24	USA	Deck fastening
VHT PZ-809-15	X-U, X-P	Germany	Deflection head fastening
RINA FPE278318CS	S-BT, S-BT-ER / -EF (HC), X-FCM-M, X-FCM-R, X-FCS	Global	Fastening to steel, Fastening to steel for off-shore applications, Fastening to steel for shipbuilding



Hilti Corporation
9494 Schaan, Liechtenstein
P +423-234 2965

www.facebook.com/hiltigroup
www.hilti.group

September 2019 / 387113